

Date 13/5/2020
 Customer
 Offer



San Toribio, 6 28031 MADRID
 +34/913030426 com@frimetal.es

DIRECT EXPANSION EVAPORATOR

FRB-225

Model Capacity **3,4 kW**
 Required Capacity **0,0 kW**

Materials

Tubes Copper
 Fins Aluminium
 Casing Aluminun and galvanized steel white coated RAL-9002

Duties

Fin Spacing **7 mm**
 Air Flow **2970 m³/h**
 Air Velocity **1,87 m/s**
 Available Air Static Pressure **0 Pa**
 Air throw **14 m**
 Air Inlet Temperature **-20,0 °C**
 Outlet Air Temperature **-22,8 °C**
 Evaporating Temperature **-27,0 °C**
 Temperature difference DT1 **7 K**
 Refrigerant **R404A**

Options

Electrical defrost

Coil

Fin Spacing **7 mm**
 Finned Length **1100 mm**
 Surface **17,5 m²**
 Internal Volume **5,7 dm³**

Installer Information

Net weight **41 kg**
 Inlet liquid distributor **1 x 1/2"**
 Outlet line **1 x 16 mm**
 Electric defrost power **3300 W**

AC Fan motors ErP compliant

Power supply	1~230V/50Hz	Total absorbed power	160 W
Fans Nr.	2	Total absorbed current	0,8 A
Blade Diameter	300 mm	Noise Power Level	67 dB(A)
Speed	1350 rpm	Noise Pressure Level	36 dB(A)
		Distance	10 m

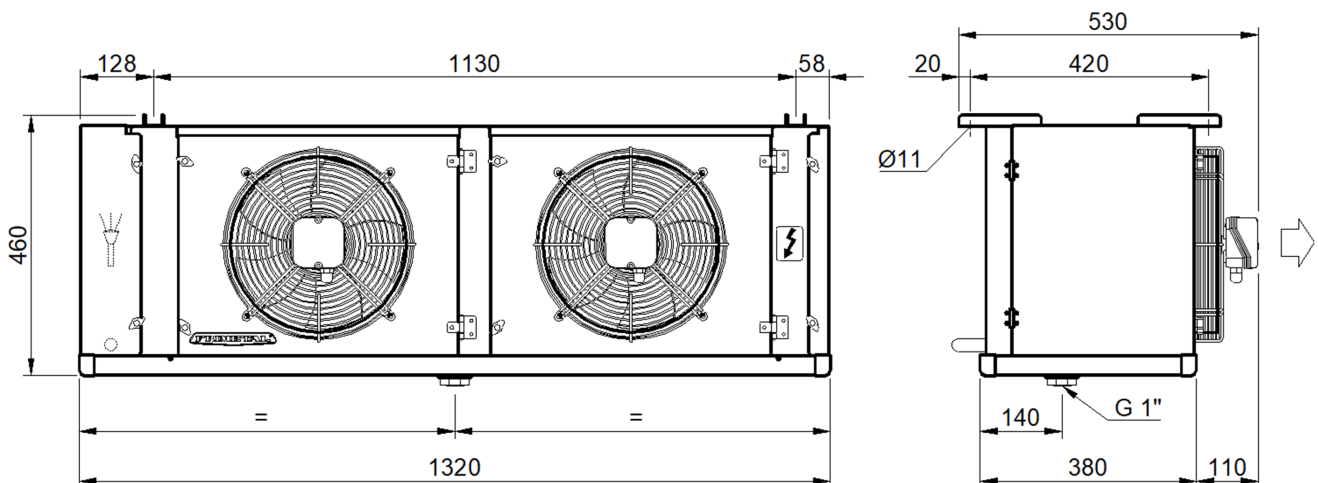

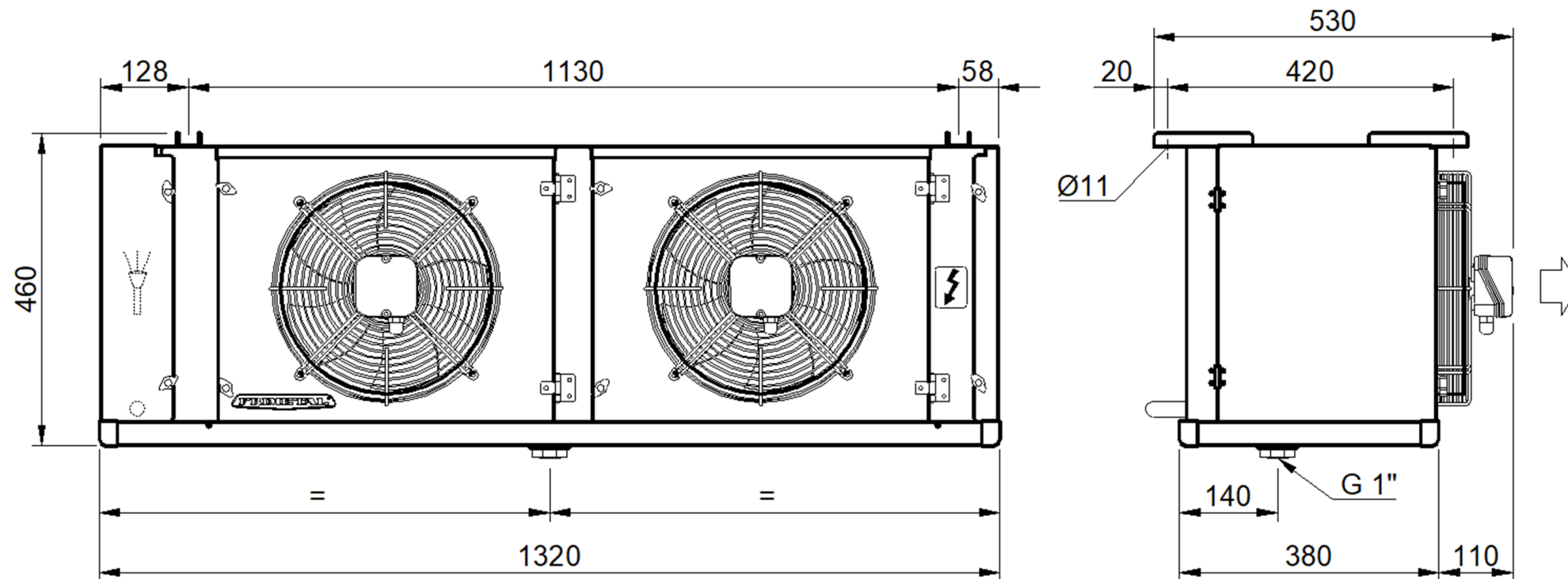

DIRECT EXPANSION EVAPORATOR - FRB-225



FRIMETAL, s.a.
 San Toribio, 6
 28031 MADRID
 +34/913030426 - +34/917774761