

Data Sheet

Case/room controller (EEV)
Type **AK-CC55**

For flexible control of refrigeration appliances and cold storage rooms.



AK-CC55 is a complete refrigeration appliance control with great flexibility to adapt to refrigeration appliances and cold storage rooms.

AK-CC55 Compact, Single Coil, and Multi Coil controllers are optimized to control refrigerated display cases or cold rooms with electronic expansion valve type AKV. In addition to the valve output, the controllers hold a pressure input, temperature sensor inputs, digital inputs as well as an analogue output and relay outputs that can be applied to numerous functionalities in a refrigeration system.

The temperature in the appliance is registered by temperature sensors in the air flow before the evaporator and after the evaporator. A setting for thermostat, alarm thermostat and display reading determines the influence the sensor values should have for the control functions. Additional sensors can be used for registration and alarming of the temperature near the food items, registration of the temperature of the evaporator and also as defrosting sensors.

Features





- Universal controller for several different refrigeration appliances
- Quick set-up with predefined settings
- Easy configuration and service using a mobile app with Bluetooth
- Energy optimization of the whole refrigeration appliance
- Adaptive Minimum Stable Superheat (MSS) control is performed with lowest possible superheat
- Allows the suction pressure to be raised several degrees
- Adaptive Liquid Control (ALC) can be performed with superheat down to 0 degrees on transcritical CO₂ systems with liquid ejectors
- Adaptive Defrost (AK-CC55 Single Coil only) that saves energy and increase food quality by only performing the defrost needed to keep the evaporator ice free.

Portfolio overview

The AK-CC55 portfolio contains four controllers with different functionalities and application settings, as outlined in the table.

For a complete breakdown on the individual controller and their functions, refer to the respective User Guide for the controllers.

Table 1: AK-CC55 Portfolio

	AK-CC55 Compact	AK-CC55 Single Coil	AK-CC55 Single Coil UI	AK-CC55 Multi Coil
Product image				
Valve	1 x TXV or AKV	1 x AKV	1 x AKV	3 x AKV
Digital Output	3	5	5	4
Digital input	1(2)	3 (2)	3 (2)	3 (2)
Analogue Output	1	1	1	1
Analogue Input	5(4)	6 (7)	6 (7)	6 (7)
Display	1 remote	2 remote	1 remote + 1 Integrated	2 remote
Comm. module	Modbus	Modbus	Modbus	Modbus
Optional comm. module		LON module	LON module	LON module

Product categories mentioned in the table are outlined in the next sections.

External display

There are three versions available with different functions.

- AK-UI55 Info: Temperature display.
- AK-UI55 Set: Temperature display with control buttons on the front.
- AK-UI55 Bluetooth: Temperature display with Bluetooth communication, for use with AK-CC Connect App.

Figure 1: AK-UI55 Info



Figure 2: AK-UI55 Set



Figure 3: AK-UI55 Bluetooth



Data communication other than MODBUS

AK-CC55 has built-in MODBUS communication. For other types of data communication, an optional RS 485 Lon module (AK-OB55) can be installed in AK-CC55 Single Coil and AK-CC55 Multi Coil controllers.

Figure 4: AK-OB55 (RS485 Lon module)

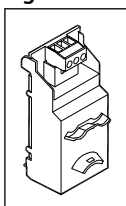

Products used in AK-CC55 systems

KoolProg

The KoolProg software enables you to perform online configuration and monitoring of AK-CC55 controllers as well as offline configuration of setting files, which can be shared with the AK-CC55 Connect APP for mobile devices. Furthermore, it allows you to make production line programming of controllers in an efficient way and to update controller firmware.

KoolProg must be connected to the display port of an AK-CC55 controller via MMIMYK gateway:

Figure 5: Connection for AK-CC55 using interface type MMIMYK

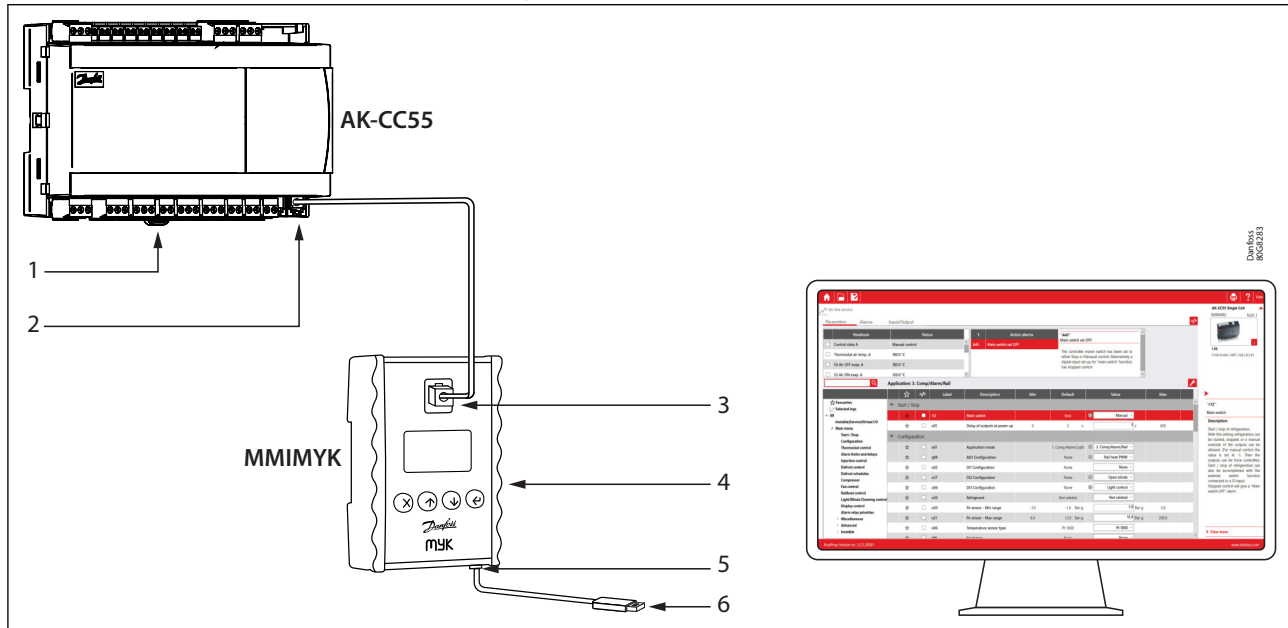

1	Power: 115 – 230 V AC	4	Power: 12 V DC
2	Display port	5	Mini-USB
3	RJ11 port	6	To PC

Electric expansion valve, type AKV 10P, AKV 10PS

Figure 6: Type AKV 10P, AKV 10PS



AKV 10P and AKV10PS are electric operated expansion valves designed for refrigerating plants.

The AKV 10P and AKV 10PS valves are normally controlled by a controller from Danfoss range of ADAP- KOOL® controllers, that ensures a precise liquid injection into evaporators.

The AKV 10P and AKV 10PS valves are supplied as a part program, as follows:

- Separate valve
- Separate coil with terminal box, DIN plug or cable
- Spare parts in the form upper part, orifice and filter

Case/room controller (EEV), type AK-CC55

The orifice assembly is replaceable. The AKV 10P and AKV 10PS valves cover a wide capacity range.

Pressure transmitter, type AKS 32R and AKS 2050

Figure 7: Type AKS 32R and AKS 2050



AKS 32R is a ratiometric pressure transmitter that converts the measured pressure to a linear output signal. The output signal is relative to the supply voltage meaning that the min. pressure output will be 10% of the actual supply voltage and the max. pressure output will be 90% of the actual supply voltage.

At a supply voltage of 5 V, the output signal is:

- 0.5 V at min pressure range
- 4.5 V at max. pressure range

The robust design and the ratiometric output signal makes the transmitter suitable for systems together with ratiometric A/D converters within a number of fields:

- A/C systems
- Refrigeration plant
- CO₂ plant
- Process control
- Laboratories

Pressure transmitter, type DST P110

Figure 8: Type DST P110



The Danfoss DST P110 series pressure transmitter is designed for demanding refrigeration, air conditioning and industrial cooling applications, such as:

- Chillers
- Transport refrigeration
- Commercial refrigeration
- Variable speed HVAC
- Heat pumps
- Variable refrigerant flow (VRF)

Drawn from over 30 years of experience with MEMS pressure sensing, the DST P110 offers outstanding performance in a compact and durable stainless-steel package.

Case/room controller (EEV), type AK-CC55

Running a powerful ARM-based microcontroller, the DST P110 offers diagnostic features and scalable performance features at a competitive price.

Colour coded temperature sensors, type AKS 11

Figure 9: Type AKS 11



Pt 1000 temperature sensor.

The sensor can be used for temperature monitoring and logging in conjunction with Danfoss controllers in the following areas:

- Refrigeration
- Air conditioning
- Heating

The sensor comes adjusted and complies with the requirements to tolerance in EN 60751, class B.

AKS 32R info

The signal from one pressure transmitter can be received by up to 10 controllers. There must not be a significant pressure drop from the pressure transmitter's position in the suction line to the individual evaporators. Other products can be part of the system as well, depending on application scope.

Functions

AK-CC55 has numerous functions, as listed below. For a complete breakdown on the individual controller and their functions, refer to the respective User Guide for the controllers.

- Day/night thermostat with ON/OFF or modulating principle.
- Product sensor S6 with separate alarm limits.
- Switch between thermostat settings via digital input.
- Adaptive control of superheat.
- Adaptive liquid control
- Oil recovery (flushing oil back to condensing unit)
- Adaptive defrosting based on diagnostics.
- Start of defrost via schedule, digital input or network.
- Natural, electric or hot gas defrost.
- Stop of defrost on time and/or temperature.
- Coordination of defrosting among several controls.
- Pulsing or speed control of fans when thermostat is satisfied.
- Appliance cleaning function for documentation of HACCP procedure.
- Rail heat control via day/night load or dew point.
- Humidity control in cold storage rooms.
- Door function.
- Control of two compressors.
- Control of night blinds.
- Light control.
- Heat thermostat.
- High accuracy inputs:
 - to guarantee a better measuring accuracy than stated in the standard EN ISO 23953-2 without subsequent calibration (Pt1000 ohm sensor).
- Support of user-defined temp. sensor type
- Integrated MODBUS communication
 - option: mounting a Lon communication card (AK-OB55).

Function overview

Table 2: AK-CC55 function overview by type

Application	AK-CC55 Compact	AK-CC55 Single Coil AK-CC55 Single Coil UI	AK-CC55 Multi Coil
AKV - application (electrically operated expansion valve)	x	x	x
0 – 10 V to control external stepper driver		x	
TXV - application (thermostatic expansion valve + solenoid valve or compressor)	x		
Remote hot gas - application		x	
One valve, one evaporator, one refrigeration section	x	x	x
One valve, one evaporator, two refrigeration sections		x	
One valve and two evaporators, two refrigeration sections		x	
Two valves and two evaporators (same refrigeration section)			x
Three valves and three evaporators (same refrigeration section)			x
Custom configuration of relay outputs	x	x	
Two compressors	x	x	
Heating function	x	x	
Control of air humidity		x	x
Adaptive superheat	x	x	x
Adaptive liquid control (zero superheat control for transcritical CO ₂ systems with liquid ejectors)	x	x	x
Adaptive defrosting		x	
Product sensor		x	
Oil recovery		x	
RS485 Lon, option (AK-OB55)		x	x

Connectivity

The diagram outlines the connectivity options presented by AK-CC55 for the design of system functionality.

Figure 10: Connectivity

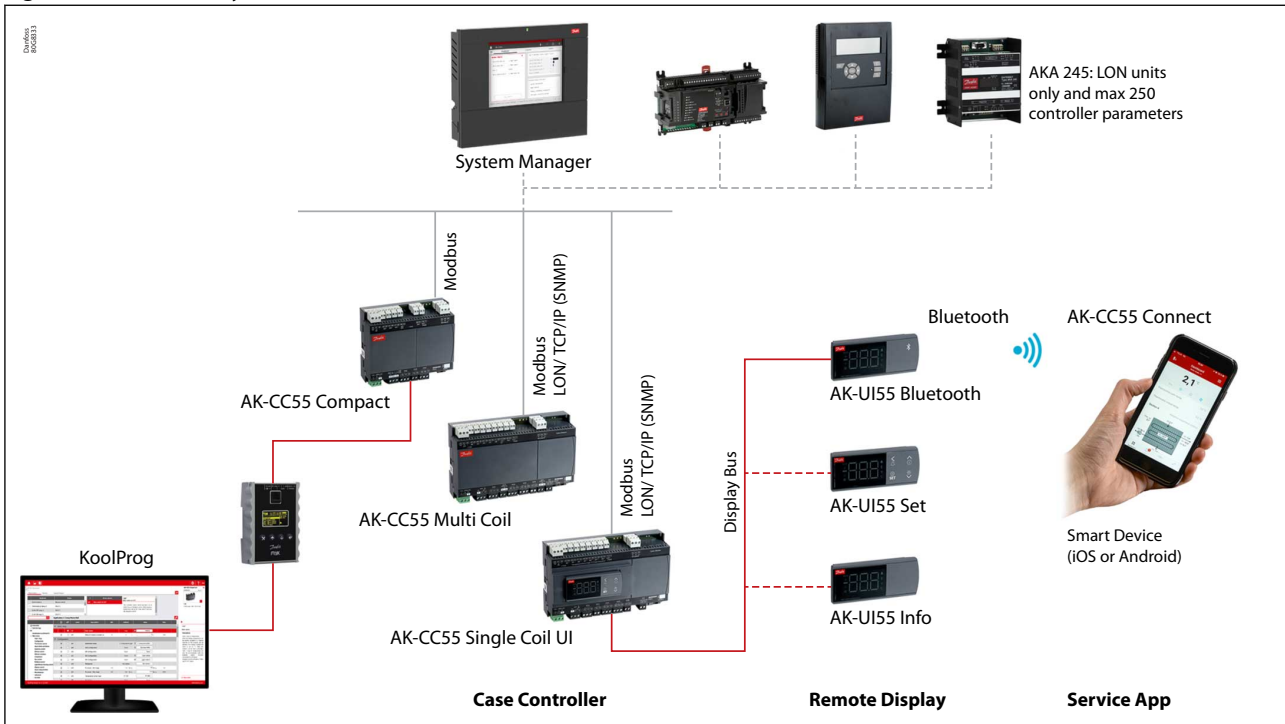

User Interface

As shown in the connectivity visual, AK-CC55 can be operated in different ways. This chapter outlines some of the options. For a complete breakdown on the individual controller and their operating procedures, refer to the respective User Guide for the controllers.

The following options are available:

- Direct operation
 - Menu button on relevant display.
 - Smart phone/app with Bluetooth communication interface ("AK-CC55 Connect").
- Operated via data communication (MODBUS or Lon - Not Compact)
 - Via system unit display, e.g. via AK-SM 800.
 - Via system unit and Service Tool.
 - Programming via interface MMIMYK and PC software type KoolProg®.

Figure 11: AK-UI55 Set display with operation

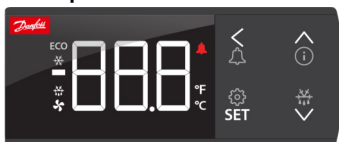

- Newly developed display with 4 operating buttons, in grey thermoplastic material
- High-visibility LED display with white characters.
- As alternative, you can use AK-UI55 Info for information readout, or AK-UI55 Bluetooth with dedicated AK-CC55 Connect app.

Applications

The chapter outlines application examples:

- Standard display case
- Cases with one valve, one evaporator and two refrigeration sections
- Cases with one valve, two evaporators and two refrigeration sections
- Cold rooms

An application setting configures inputs and outputs so that the controller operation interface reflects the selected application.

Some of the relay outputs are optional, i.e. users define what the relay will be used for, e.g.:

- Controlling two compressors
- Controlling the night blind
- Controlling the heat function
- ECO operations of fans (only Compact/Single Coil)

Figure 12: Standard display case, upright or normal, with one evaporator

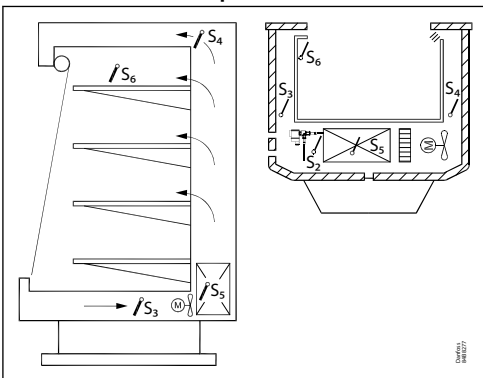

Figure 13: Examples of display case configurations, with two refrigeration sections controlled by one AKV valve (only Single Coil)

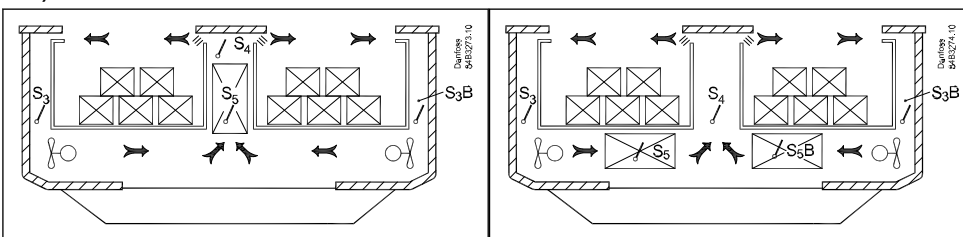
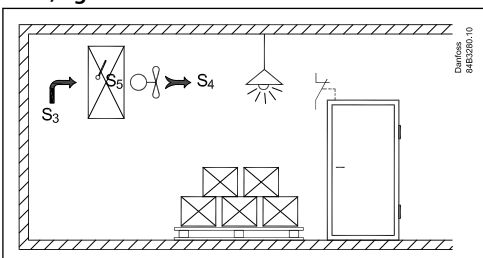

Figure 14: Cold room configuration with door, light and heat control function



NOTE:

Temperature sensor positions are indicated with S followed by relevant number. Fans, air flows, night blinds, door and heat functions are indicated by symbols.

Application options for AK-CC55 Compact

Upper and lower connection panels are laid out as shown in figure:

Figure 15: Electrical connections AK-CC55 Compact

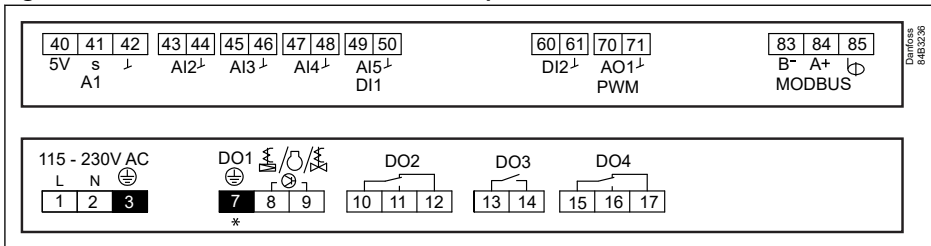

* Max. 0.5 A - No overload protection!

AK-CC55 Compact is optimised for control of one evaporator plus different combinations of light, rail heat and alarm relays. It has 9 different application options (**Application 1 – Application 9**) to control the functions of the input and output relays.

Table 3: The controller covers the following nine applications

Application 1-4	Designed for TXV applications, for control of compressor or solenoid valve, alarm relay, lights and rail heat.
Application 5-9	Designed for EEV applications, for control of valves in the AKV family, compressor, alarm relay, light and rail heat.
Application 4	Can also be used as a user defined configuration with Thermostatic expansion valves (TXV), e.g.: Dual compressor operation, heat function, night blind, ECO fan.
Application 9	Can also be used as a user defined configuration with Electric Expansion Valves (EEV), e.g.: Dual compressor operation, heat function, night blind, ECO fan.

Table 4: AK-CC55 Compact application options overview

No.	Application description	DO1	DO2	DO3	DO4	AO1	AI1	AI2	AI3	AI4	AI5/ DI1	DI2
1	TXV appl.					●		S3	S4	S5	●	●
2	TXV appl.					●		S3	S4	S5	●	●
3	TXV appl.					●		S3	S4	S5	●	●
4	TXV appl./ User def. config.		User def.	User def.	User def.	●		S3	S4	S5	●	●
5	EEV appl.					●	Pe	S2	S3	S4	S5	●
6	EEV appl.					●	Pe	S2	S3	S4	S5	●
7	EEV appl.					●	Pe	S2	S3	S4	S5	●
8	EEV appl.					●	Pe	S2	S3	S4	S5	●
9	EEV appl./ User def. config.		User def.	User def.	User def.	●	Pe	S2	S3	S4	S5	●

● = Optional use

Application options for AK-CC55 Single Coil

Upper and lower connection panels are laid out as shown in figure:

Figure 16: Electrical connections AK-CC55 Single Coil

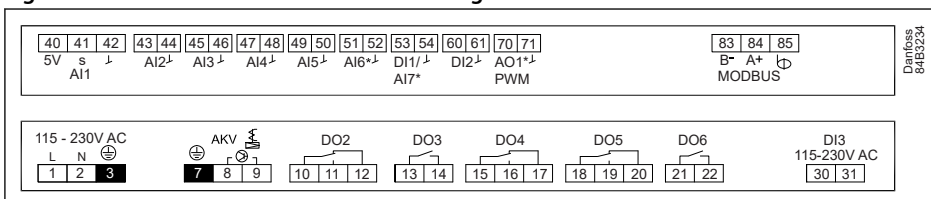

AK-CC55 Single Coil is optimised for control of one expansion valve + different combinations of light, rail heat and alarm relays.

Case/room controller (EEV), type AK-CC55

Table 5: The controller covers the following nine applications

Application 1-3	Plug-in cabinets. Cabinets with different output combinations of alarm, rail heat and light.
Application 4	Remote cabinet including alarm, rail heat, defrost, light and fan.
Application 5	Remote hot gas defrost with suction, drain and hot gas valve.
Application 6	Back-to-back cabinet with one evaporator.
Application 7	Back-to-back cabinet with two evaporators.
Application 8	Cold storage room with defrost and simple humidity control.
Application 9	Custom defined application, where the outputs can be configured according to custom requirements

Table 6: Application with digital and analogue output specification

No.	Application description	DO1	DO2	DO3	DO4	DO5	DO6	AO1
1	Plug-in cabinet							●
2	Plug-in cabinet							●
3	Plug-in cabinet							●
4	Remote cabinet							●
5	Remote Hot gas defrost							●
6	Back-to-back cabinet							●
7	Back-to-back cabinet							●
8	Cold storage room							●
9	User def. config.		User def.	User def.	User def.	User def.	User def.	●

● = Optional use

Table 7: Application with digital and analogue input specification

No.	Application description	AI1	AI2	AI3	AI4	AI5	AI6	AI7/DI1	DI2	DI3
1	Plug-in cabinet	Pe	S2	S3	S4	S5	S6	●	●	●
2	Plug-in cabinet	Pe	S2	S3	S4	S5	S6	●	●	●
3	Plug-in cabinet	Pe	S2	S3	S4	S5	S6	●	●	●
4	Remote cabinet	Pe	S2	S3	S4	S5	S6	●	●	●
5	Remote Hot gas defrost	Pe	S2	S3	S4	S5	S6	●	●	●
6	Back-to-back cabinet	Pe	S2	S3	S4	S5	S3B	●	●	●
7	Back-to-back cabinet	Pe	S2	S3	S4	S5	S3B	S5B	●	●
8	Cold storage room	Pe	S2	S3	S4	S5	S6	RH%	●	●
9	User def. config.	Pe	S2	S3	S4	S5	S6	●	●	●

● = Optional use

Application options for AK-CC55 Multi Coil

Upper and lower connection panels are laid out as shown in figure:

Figure 17: Electrical connections AK-CC55 Multi Coil

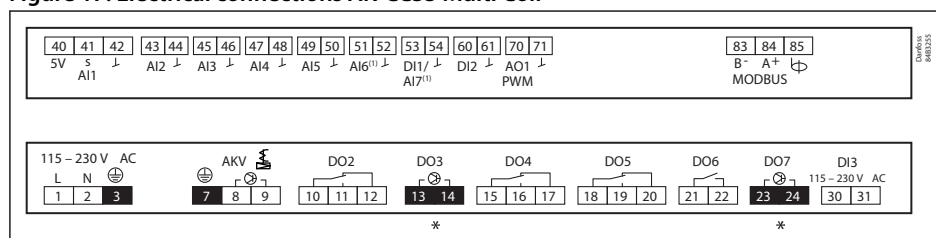

(1) See Table 10

* Max. 0.5 A - No overload protection!

Case/room controller (EEV), type AK-CC55

AK-CC55 Multi Coil is optimized for control of one to three expansion valves, lights and different combinations of rail heat and alarm relays.

Table 8: The controller covers the following five applications:

Application 1-3	Control of one, two and three evaporators.
Application 4	Control of high temperature cold rooms with two evaporators.
Application 5	Control of low temperature cold rooms with two evaporators.

Table 9: AK-CC55 Multi Coil Application with Digital and Analogue output specification

No.	Application description	DO1	DO2	DO3	DO4	DO5	DO6	DO7	A01
1	1 evaporator								●
2	2 evaporators								●
3	3 evaporators								●
4	Cold room								●
5	Cold room								●

● = Optional use

Table 10: AK-CC55 Multi Coil Application with Digital and Analogue input specification

No.	Application description	AI1	AI2	AI3	AI4	AI5	AI6	AI7/DI1	DI2	DI3
1	1 evaporator	Pe	S2A	S4A	S5A			●	●	●
2	2 evaporators	Pe	S2A	S4A	S5A	S2B	S4B	S5B	●	●
3	3 evaporators	Pe	S2A	S4A	S5B	S4B	S2C	S4C	●	●
4	Cold room	Pe	S2A	S4A	S5B	S4B	RH%	●	●	●
5	Cold room	Pe	S2A	S4A	S5B	S2B	S4B	S5B	●	●

● = Optional use

Product specification

Product identification

The controller is provided with labels from the factory, indicating a generic application. When selecting the required application, specific labels are provided so that you can mount the relevant one.

The application number is indicated on the left-hand side of the labels. Use the label fitting the selected application.

Some of the labels are applicable to multiple application options.

Figure 18: Labels used to indicate application number

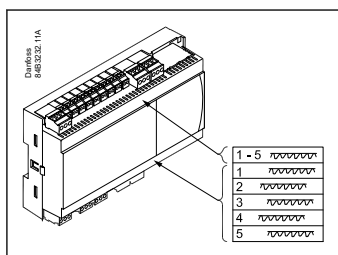

Technical data

Electrical specifications

Table 11: Electrical specifications

Electrical data	Value
Supply voltage AC [V]	115 V / 230 V, 50/60 Hz
Power consumption [VA]	5 VA
Power ON indicator	Green LED
Electrical cable dimensioning [mm ²]	Max.1.5 mm ² multi-core cable

Sensor and measuring data

Table 12: Sensor and measuring data

Sensor and measuring data	Value
Sensor S2, S6 (only Single Coil)	Pt1000
Sensor S3, S4, S5	Pt1000 PTC1000 NTC5K NTC10K (All 3 must be of the same type)
Temperature measuring accuracy	Pt1000: -60 – 120 °C. ±0.5 K PTC1000: -60 – 80 °C. ±0.5 K NTC5K: -40 – 80 °C. ±1.0 K NTC10K: -40 – 120 °C. ±1.0 K
Pt1000 sensor specification	±0.3 K at 0 °C ±0.005 K per degree
Pe measuring	AKS 32R Ratiometric pressure transmitter: 10 – 90%
RH measuring (only Single/Multi Coil)	0 – 10 V Ri > 10K ohm Accuracy +/- 0,3% FS

Input and output relay specifications

Table 13: Input and output relay specifications

Input and output relay specifications	Input/output	Description
Digital input	DI1 DI2	Signal from dry contact functions Requirements to contacts: Gold plating Cable length must be max. 15 m Use auxiliary relays when the cable is longer Open loop: 12 V (SELV) Contact 3.5 mA
Digital input	DI3 (only Single/Multi Coil)	115 V / 230 V AC
Solid state output	DO1 (for AKV coil) (And DO3 and DO7 in Multi Coil)	115 V / 230 V AC Max. 0.5 A DO3 and DO7 (No overload protection) Max. 1 x 20 W AKV for 115 V AC 2 x 20 W AKV for 230 V AC NOTE: 2 EC coils are not supported
Relays	DO2 DO3 DO4 DO5 DO6	115 V / 230 V AC Load max.: CE. 8 (6)A UL. 8A res. 3FLA 18LRA Load min.: 1VA Inrush: DO2 DO3 for Compact DO5 DO6 for Single/Multi Coil TV-5 80A
Analogue output/ PWM	AO1	0 / 10 V Pulse Width Modulated (PWM) max. 15 mA. 0 – 10 V variable, max. 2 mA

DO2, DO4, DO5 and DO6 are 16 A relays.

Max. load must be observed.

DO3 / DO4 for Compact and DO5 / DO6 for Single / Multi Coil is recommended for EC Fan and LED light.

All relays are sealed for use with flammable refrigerant like Propane R290.

Compliance with EN 60 335-2-89: 2010 Annex BB.

Function data

Table 14: Function data

Function data	Value
Display	LED 3 digit
External display, AK-CC55 Compact	1 external display
External display, AK-CC55 Single Coil UI	1 external display
External display, AK-CC55 Single Coil	2 external displays
External display, AK-CC55 Multi Coil	2 external displays
External display connection	RJ12
Max. display cable length [m]	100 m
Data communication built-in	MODBUS
Data communication option	AK-OB55 Lon RS485 module (Not AK-CC55 Compact)
Clock battery backup power reserve	4 days
Mounting	DIN rail

Environmental conditions

Table 15: Environmental conditions

Environmental conditions	Value
Ambient temperature range, operation [°C]	0 – 55 °C
Ambient temperature range, transport [°C]	-40 – 70 °C
Enclosure rating IP	IP20
Relative humidity range [%]	20 – 80%, non-condensing
Shocks/Vibrations	No shocks and vibrations allowed

Dimensions

Table 16: Dimensions







<p>AK-CC55 Compact</p>	<p>AK-CC55 Single Coil</p>
<p>AK-CC55 Single Coil UI</p>	<p>AK-CC55 Multi Coil</p>
<p>AK-CC55 Set</p>	<p>AK-UI55 Mounting Base</p>
<p>AK-OB55 (Data communication module Lon)⁽¹⁾</p>	

⁽¹⁾ Can be installed on Single Coil and Multi Coil versions.

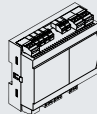
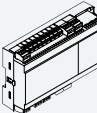
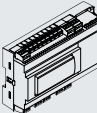
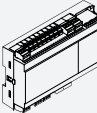
Ordering

The list contains the components that make up an AK-CC55 setup. For other Danfoss products mentioned in the document, such as sensors and valves, refer to relevant product documentation.

Table 17: Ordering

Type	Symbol	Function	Code no.
AK-CC55 Compact		Case controller for one AKV or solenoid valve	084B4081
AK-CC55 Single Coil		Case controller for one AKV valve	084B4082
AK-CC55 Single Coil UI		Case controller for one AKV valve Integrated display with control buttons	084B4083
AK-CC55 Multi Coil		Case controller for one, two or three AKV valves	084B4084
AK-UI55 Info		External display	084B4077
AK-UI55 Bluetooth		External display with Bluetooth operation	084B4075
AK-UI55 Set		External display with control buttons	084B4076
AK-UI55 Mounting Base		Mounting kit for display types: AK-UI55 Set, AK-UI55 Bluetooth, AK-UI55 Info	084B4099
AK-UI cable		External display cable with RJ12 connector. 3 m	084B4078
AK-UI cable		External display cable with RJ12 connector. 6 m	084B4079
AK-OB55 Lon		Data communication module Lon Can be mounted in Single Coil and Multi Coil versions	084B4070
MMIMYK		Gateway between AK-CC55 and PC installed with KoolProg software	080G0073

Certificates, declarations, and approvals

The list contains all certificates, declarations, and approvals for this product type. Individual code number may have some or all of these approvals, and certain local approvals may not appear on the list.

Some approvals may change over time. You can check the most current status at danfoss.com or contact your local Danfoss representative if you have any questions.

Table 18: Controller

Control	Certification	Mark	Country
All AK-CC55 Controllers	EMC/LVD/RoHS	CE	EU
All AK-CC55 Controllers	UL recognized	cURus	NAM (US and Canada)
All AK-CC55 Controllers	ACMA (EMC)	RCM	Australia/New Zealand
All AK-CC55 Controllers	LVE/EMC/RoHS	EAC	Russia, Kazakhstan, Belarus
All AK-CC55 Controllers	LVD/EMC/RoHS	UA	Ukraine

Table 19: Display module

Display module	Certification	Mark	Country
AK-UI55 Bluetooth	RED	CE	EU
AK-UI55 Bluetooth	FCC	FCC ID	USA
AK-UI55 Bluetooth	IC (ISED)	IC ID	Canada
AK-UI55 Bluetooth	CMIIT	CMITT ID	China
AK-UI55 Bluetooth	ACMA (EMC/Wireless)	RCM	Australia
AK-UI55 Bluetooth	RSM (EMC/Wireless)	RCM	New Zealand
AK-UI55 Bluetooth	EMC/LVD/Wireless	UA	Ukraine
AK-UI55 Bluetooth	ANATEL	ANATEL ID	Brazil
AK-UI55 Bluetooth	SUBTEL	N/A	Chile
AK-UI55 Bluetooth	RoHS	EAC	Russia, Kazakhstan, Belarus
AK-UI55 Info	EMC/LVD	UA	Ukraine
AK-UI55 Info	ACMA (EMC)	RCM	Australia
AK-UI55 Info	RSM (EMC)	RCM	New Zealand
AK-UI55 Info	RoHS	EAC	Russia, Kazakhstan, belarus
AK-UI55 Set	EMC/LVD	UA	Ukraine
AK-UI55 Set	ACMA (EMC)	RCM	Australia
AK-UI55 Set	RSM (EMC)	RCM	New Zealand
AK-UI55 Set	RoHS	EAC	Russia, Kazakhstan, belarus

Table 20: Option module

Option module	Certification	Mark	Country
AK-OB55 Lon (not Compact)	EMC/LVD	UA	Ukraine

Controllers/displays/option module:

CB certificate including all deviation according to IEC 60730-1 and 2-9

Statements for the AK-UI55 Bluetooth display

FCC COMPLIANCE STATEMENT

⚠ CAUTION:

Changes or modifications not expressly approved could void your authority to use this equipment. This device complies with Part 15 of the FCC Rules. Operation is subject to the following two conditions: (1) This device may not cause harmful interference, and (2) this device must accept any interference received, including interference that may cause undesired operation.

INDUSTRY CANADA STATEMENT

This device complies with Industry Canada license-exempt RSS standard(s). Operation is subject to the following two conditions: (1) this device may not cause interference, and (2) this device must accept any interference, including interference that may cause undesired operation of the device.

Le présent appareil est conforme aux CNR d'Industrie Canada applicables aux appareils radio exempts de licence. L'exploitation est autorisée aux deux conditions suivantes : (1) l'appareil ne doit pas produire de brouillage, et (2) l'utilisateur de l'appareil doit accepter tout brouillage radioélectrique subi, même si le brouillage est susceptible d'en compromettre le fonctionnement.

Online support

Danfoss offers a wide range of support along with our products, including digital product information, software, mobile apps, and expert guidance. See the possibilities below.

The Danfoss Product Store



The Danfoss Product Store is your one-stop shop for everything product related—no matter where you are in the world or what area of the cooling industry you work in. Get quick access to essential information like product specs, code numbers, technical documentation, certifications, accessories, and more.

Start browsing at store.danfoss.com.

Find technical documentation



Find the technical documentation you need to get your project up and running. Get direct access to our official collection of data sheets, certificates and declarations, manuals and guides, 3D models and drawings, case stories, brochures, and much more.

Start searching now at www.danfoss.com/en/service-and-support/documentation.

Get local information and support



Local Danfoss websites are the main sources for help and information about our company and products. Find product availability, get the latest regional news, or connect with a nearby expert—all in your own language.

Find your local Danfoss website here: www.danfoss.com/en/choose-region.

AK-CC55 Connect



Make service easy with the free AK-CC55 Connect app. Via a Danfoss Bluetooth display you can connect to an AK-CC55 case controller and get a visual overview of the display functions. The app ensures smooth interaction with a Danfoss AK-CC55 case controller in a user-friendly design.

Download the app here:



Play Store



App Store

Any information, including, but not limited to information on selection of product, its application or use, product design, weight, dimensions, capacity or any other technical data in product manuals, catalogues descriptions, advertisements, etc. and whether made available in writing, orally, electronically, online or via download, shall be considered informative, and is only binding if and to the extent, explicit reference is made in a quotation or order confirmation. Danfoss cannot accept any responsibility for possible errors in catalogues, brochures, videos and other material. Danfoss reserves the right to alter its products without notice. This also applies to products ordered but not delivered provided that such alterations can be made without changes to form, fit or function of the product. All trademarks in this material are property of Danfoss A/S or Danfoss group companies. Danfoss and the Danfoss logo are trademarks of Danfoss A/S. All rights reserved.