

Two section air-water heat pump for heating, cooling and DHW production

SPHERA EVO 2.0 - Tower

SQKN-YEE 1 TC + MiSAN-YEE 1 S 2.1 ÷ 8.1 RANGE

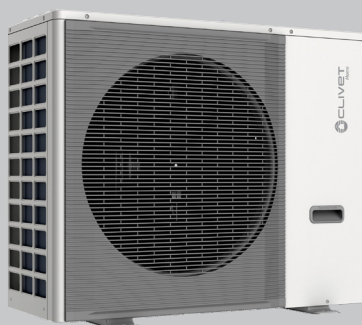
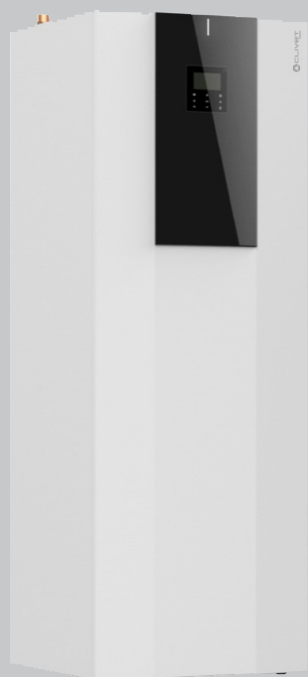

TECHNICAL BULLETIN



SIZE	2.1	3.1	4.1	5.1	6.1	7.1	8.1
HEATING CAPACITY KW	4,32	6,18	8,30	10,9	12,13	14,51	16,01
COOLING CAPACITY KW	4,55	6,44	8,10	10,00	12,06	13,79	14,84

DHW STORAGE

190 L - A

250 L - A -B

Page

3	Features and benefits
4	Standard unit technical specifications
6	Built-in options
7	Accessories separately supplied
15	General technical data
28	Refrigerant pipe connection
29	Water connections
30	Electrical connections
31	System connections
34	Data for the UNI/TS 11300 calculation
38	Energy requalification
39	EuroSwitch Function
40	Dimensional drawings



Clivet is taking part in the EUROVENT certification programme up to 1.500 kW. The products concerned appear in the certified products list of the EUROVENT www.eurovent-certification.com site.

Features and benefits

SPHERA EVO 2.0 is a specialised autonomous heat pump system for single- and multi-family homes with medium/low and high power consumption.

Is an air-water heat pump system for cooling and producing/storing domestic hot water.

The SPHERA EVO 2.0 system is composed of a latest generation high efficiency outdoors moto-condensing unit connected via refrigerant connections to an indoors unit.

It is the second generation of heat pumps for residential use.

SPHERA EVO 2.0 Tower

- Tower Version
- Two volumes of DHW 190 and 250-litres
- Class A++ Average temperature
- Class A+ Domestic hot water production
- Built-in WiFi for connection to the dedicated APP
- Also available in the hybrid version with 24 kW or 34 kW gas boiler



SPHERA EVO 2.0 Box

- Box Version
- Integrated 3-way valve for DHW
- Compact dimensions
- Class A+++ Low temperature
- Built-in WiFi for connection to the dedicated APP
- Also available in the hybrid version with 24 kW or 34 kW gas boiler



SPHERA EVO 2.0 Invisible

- Version for built-in installation
- 50-litre DHW storage can be expanded up to 300-litres
- Compact dimensions for easy installation in walls
- Also available in the hybrid version with 24 kW gas boiler
- Built-in WiFi for connection to the dedicated APP



SPHERA EVO 2.0 - Tower - Indoor unit

Zinc-Magnesium frame

Supporting frame in Zinc-Magnesium panelling, excellent mechanical characteristics and high resistance to corrosion over time.

Panelling

External panelling in zinc-magnesium sheet, with white paint in RAL 9003 to ensure better resistance to corrosion. Panels that can be easily removed to allow full access to internal components.

Internal exchanger

Direct expansion heat exchanger with INOX AISI 316 stainless steel braze-welded plates. With low refrigerant content and high exchange surface, complete with external anti-condensation thermal insulation 10 mm thick in sintered expanded polypropylene.

Domestic hot water

- 190-litre or 250-litre DHW storage tank with vitrified internal surface and external polyurethane insulation (50mm thick)
- Magnesium anode
- 2 kW safety and anti-legionella heating element
- Internal exchanger in vitrified steel with an exchange surface of 2 m²
- Set-up for domestic hot water recirculation circuit
- Storage discharge stop valve
- Probe sump for solar thermal system control

Hydronics module

- Variable flow direct current primary circulator
- Safety flow switch for water flow
- 3-way switching valve for system or domestic hot water
- 3 bar system water side pressure relief valve
- Magnetic dirt separator
- System vent valve
- 8 litre system expansion tank, 1 bar pre-charge
- Drain pan in ABS

Electrical panel

The electrical panel is located inside the unit and is easily accessible thanks to removable panel. Moreover, a LED on the front panel is connected to check the operating status of the unit.

The capacity section includes:

- power input terminals.

The control section includes:

- remote microprocessor control with single-area thermostat function;
- BMS management;
- daily, weekly temperature set point and start-up/shutdown scheduler;
- anti-legionella function scheduling;
- management busters two zones;
- solar thermal management;
- management for auxiliary heaters;
- antifreeze protection water side;
- no water flow-rate protection with flow switch;
- remote interface terminal with graphic display;
- cascade operation.
- Inside the electrical panel there is a T1B temperature probe for low temperature area control in the 2-area kit (length 4.5 m and 6 mm bulb).

Standard unit kit:

- Mesh filter for system water
- Copper gas reduction for 4-6 kW outdoor unit connection
- Fittings for unit connection
- Ball shut-off valve for system isolation
- Torx key and insert for opening and closing the unit's panels
- Adjustable feet that can be screwed on the base of the unit
- Cover cap for remotely controlled keypad

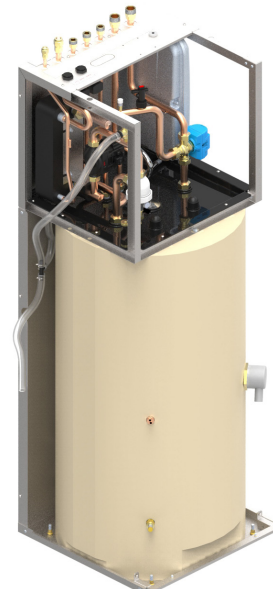

Standard unit technical specifications

SPHERA EVO 2.0 - Outdoor unit

Zinc-Magnesium frame

High strength frame for outstanding durability and excellent mechanical characteristics.

Panelling

Outer panelling made of Zinc-Magnesium sheet metal painted with pantone warm gray 2C to ensure superior corrosion resistance. Each panel can be easily removed to allow full access to internal components.

Rotary DC inverter compressor

Inverter controlled rotary hermetic compressor for constant modulation of the power supplied according to actual needs, ensuring high seasonal efficiency. With a motor protection device for overheating, overcurrents and excessive temperatures of the supply gas. It is installed on anti-vibration mounts and it is equipped with oil charge. The compressor is wrapped by a sound-absorbing hood, that reduces its sound emissions. A guard heater with automatic insertion prevents the refrigerant from diluting the oil when the compressor stops.

EC inverter fan

Axial fan with variable speed control and sickle shaped blades in ABS resin. It is directly coupled to the electronically controlled motor (IP23), which, thanks to brushless technology and the particular power supply, increases its lifespan and reduces consumption. The fan is housed in an aerodynamically shaped nozzle to increase efficiency and minimise noise. It is also fitted with anti-intrusion grid.

External exchanger

Direct expansion finned coil exchanger made with copper pipes mechanically expanded to better adhere to the fin collar. It has a large surface area to improve heat exchange and reduce defrosting in the interest of seasonal efficiency. The fins are made of aluminium with hydrophilic treatment which facilitates the elimination of condensate, further improving defrosting.

Refrigerant circuit

The refrigeration circuit includes:

- Electronic expansion valve
- 4-way cycle inversion valve
- Liquid separator in extraction
- Mechanical filters
- Low pressure pressure switch
- High pressure pressure switch



EH024

Integration electric heater

EH3

The electric heater can operate both for the system and for the production of domestic hot water in two different modes:

EH6

EH9

- as an integration, when the heat pump capacity is not enough to fulfil the required set point;
- as a safety element if the heat pump fails.

- ⚠ The additional electric heater is not an accessory supplied separately, but a construction configuration.
- ⚠ Selection of the additional three-phase (6 e 9kW) electric heater changes the voltage of the indoor unit only. The outdoor unit remains with single phase power supply.
- ⚠ Selection of the additional three-phase electric heater changes the voltage of the indoor unit only. The outdoor unit remains with single phase power supply.



Accessories separately supplied

**KIRE2HX -
KIRE2HLX**

2 zones: external kit, both at high temperature

2 zones: external kit, high temperature + low temperature (mixed)

Distribution module for 2-zone heating systems with compact design (402mm x 250mm x h525mm) and ample versatility for different types of installation.

Kit composed of:

- 1 collector / Black painted separator;
- 2 circulator;
- 1 sliding temperature mixing valve (only for the kit KIRE2HL);
- 1 EPP insulation (front and rear);
- 1 threaded disc with hermetic sealing cap;
- 1 lower anti-rotation jig;
- 1 support bracket module,
- 1 sonda per la gestione della temperatura del circuito miscelato



For the technical data of the hydraulic head of the pumps, please refer to the dedicated section in the HYDRAULIC DATA chapter.

KCSX

Secondary circuit kit (1-litre circuit breaker + pump)

The single-zone kit consists of a DIX hydraulic separator combined with a high efficiency pump, all inside a box for easy installation. Allows interaction between the primary circuit circulator and the secondary circuit circulator. Furthermore, the separator also has the function of a deaerator. With the following benefits and advantages:

- makes the connected hydraulic circuits independent;
- ensures effective operation of the secondary circulator that provides the hydraulic demand of air conditioning systems
- air extraction system;
- thermally insulated black EPP
- zone manifold connection kit

The kit is comprised of:

- 1 1-litre circuit breaker;
- 2 copper pipes;
- 1 circulator;
- closing plates

Dimensions:
Length 457 mm
Height 457 mm
Depth 133 mm



DIMENSIONAL

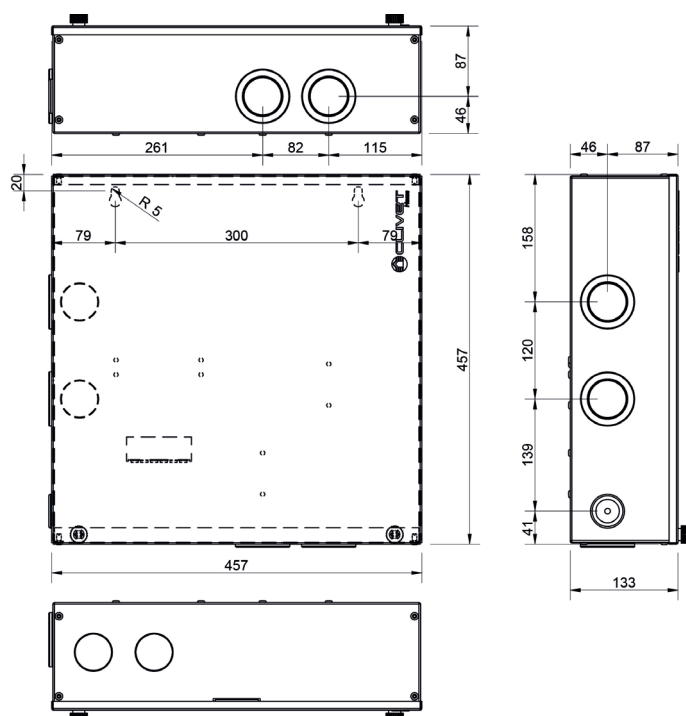

DIX 1-litre circuit braker

The CP60 hydraulic separator is a compensation chamber designed to make connected hydraulic circuits independent. It is used when the circulator of the primary circuit interacts with one or more parts of the secondary circuit in the same system. Furthermore, the separator performs the function of a deaerator.

With the following benefits and advantages:

- makes the connected hydraulic circuits independent;
- ensures effective operation of the secondary circulators that provide the hydraulic demand of air conditioning systems
- air extraction system;
- thermally insulated black EPP
- zone manifold connection kit

Technical data:

Nominal diameter DN 20

Connection 1" F

Max overall dimensions 120 x 420 x 945

Max temperature 110°C

Max pressure 6 bar

Circuit breaker material S235 steel

Insulation material EPP (40 g/l)

Insulation thickness 20 mm

The kit is supplied with a plate for wall mounting



DIMENSIONAL

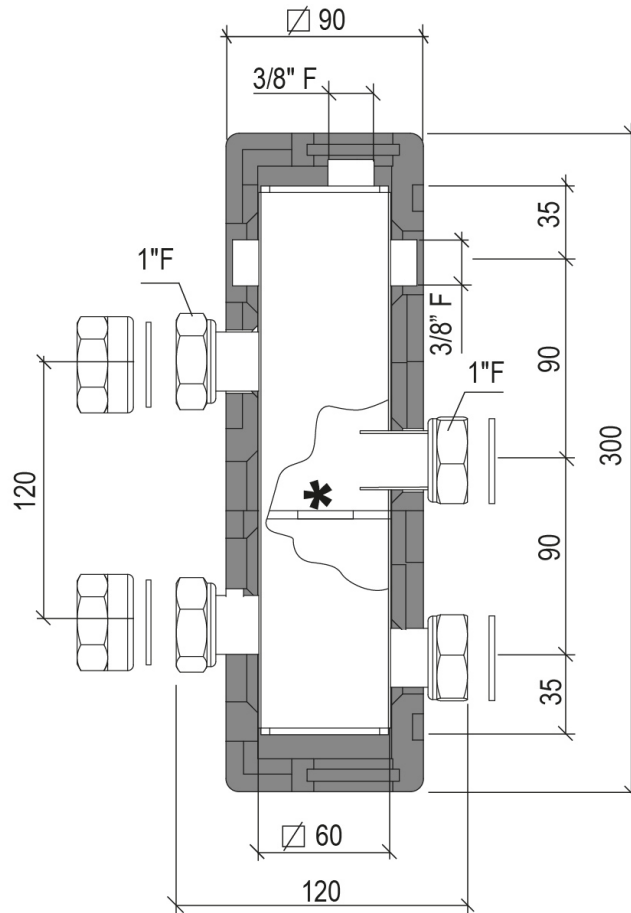

Accessories separately supplied

DI50X
ACI60X

50-litre circuit breaker
60-litre system inertial storage tank

Technical 50-litre storage tank with the function of a hydraulic separator and inertial tank ensures effective operation of the secondary circulators that provide the hydraulic demand of air conditioning systems.

Technical data:

Circuit breaker diameter 380 mm

Circuit breaker height 933 mm

Connections 1"1/4 F

Max temperature 95°C

Max pressure 6 bar

Circuit breaker material S235JR steel

Circuit breaker capacity 57 litres

Circuit breaker weight 25 kg

Insulation material Polyurethane foam

Insulation thickness 40 mm

Energy class B

Specific heat loss 0.76 W/K

The kit is supplied with brackets for wall mounting.

DIMENSIONAL

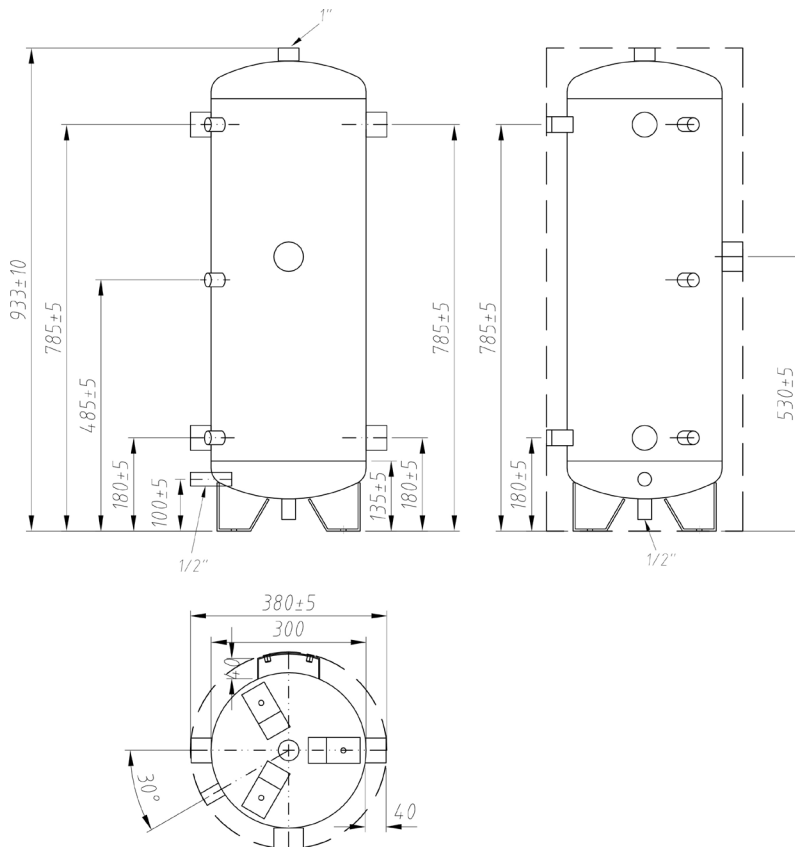

ACSA250X 250L additional domestic hot water storage tank

Additional storage tank to increase the available amount of domestic hot water.

The kit includes:

- 250-litre DHW storage tank in vitrified steel with external polyurethane insulation (50mm thick) and magnesium anode;
- circulation pump, ensures both storage tanks are at the same temperature;
- 16-litre DHW side expansion tank, 1.5 bar pre-charge;
- DHW side pressure relief valve set at 6 bar;
- anti-scalding thermostatic valve;
- set-up for DHW recirculation (recirculation pump not included);
- drain pan;
- temperature probe for additional storage tank;
- storage tank drain valve.

For the technical characteristics of the storage tank, use those of the standard 250L storage tank



DIMENSIONAL

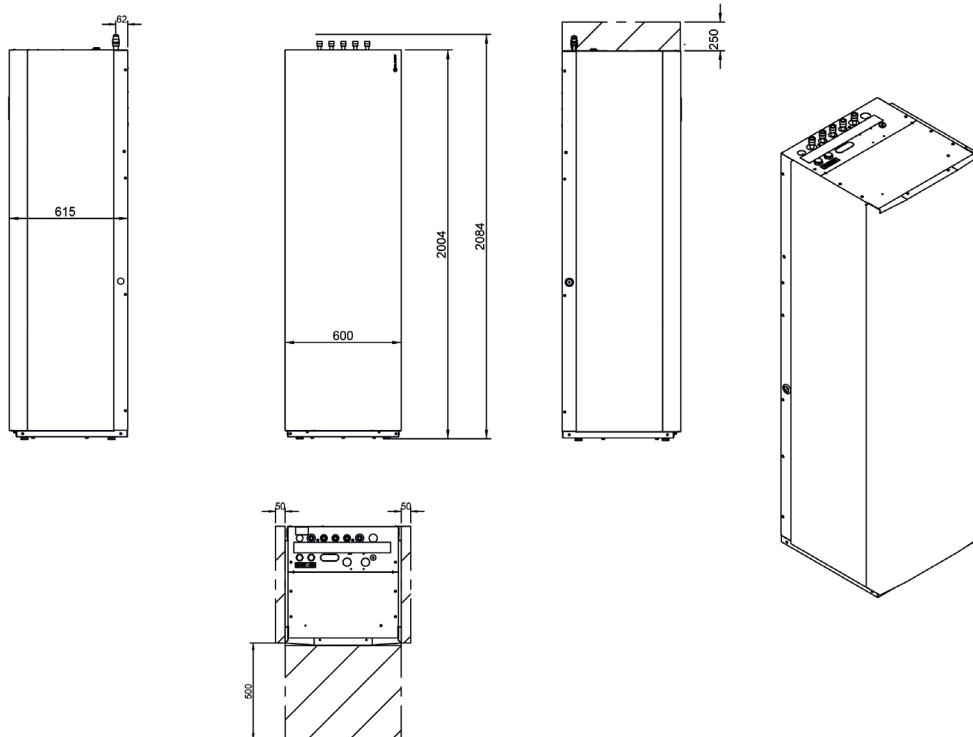

ACI40X 40L system inertial storage tank

Inertial storage tank to be installed outside the unit. Extremely compact, supplied with air vents and support brackets for wall installation. Suitable for all SPHERA EVO 2.0 sizes, it facilitates operation and helps to fulfil the heat requirement, guaranteeing optimal modulation.

It can be installed next to or behind the unit, as shown in the figure.

Kit consisting of:

- 140-litre ST371 steel storage tank for ACI40X
- 12-metre flexible hose
- Extremely compact:
LENGTH: 440 mm
DEPTH: 220 mm
HEIGHT: 887 mm
- Maximum working temperature: 100°C
- Maximum operating pressure: 6 bar
- Thermally-isolated with EPP 40 g/l
- Insulation thickness 30 mm
- Automatic air vent

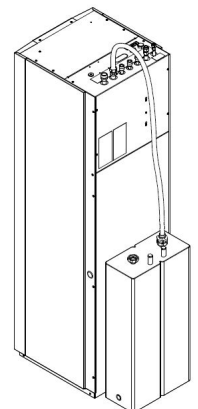

Accessories separately supplied

COFX

Casing sheets for the inertial storage cover

Decorative metal sheets serving as a cover for the inertial storage tank, if installed at the back of the unit.



SOLX

Drain-back solar integration for domestic hot water

The kit, which can be installed inside the unit, consists of:

- 1 Brazed plate heat exchanger in stainless steel (AISI 316) for domestic hot water production
- 1 Circulator
- 1 Exchanger support
- Copper connection pipes
- 2 plastic supports

In this case, a solar system circulation unit must be hooked up; this can be installed outside the unit. For the components and sizing of the system of solar collectors, refer to the ELFOSun technical documentation.

A 2kW heating element is submerged in the tank which operates when the refrigeration system fails or to complete the anti-legionella cycle as a backup for the compressor.

For proper operation, the solar panel controller's temperature sensor must be installed in the SPHERA EVO 2.0 storage tank sump.

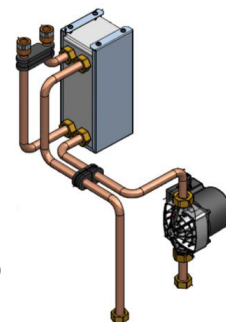

Solar heat exchanger pressure drop

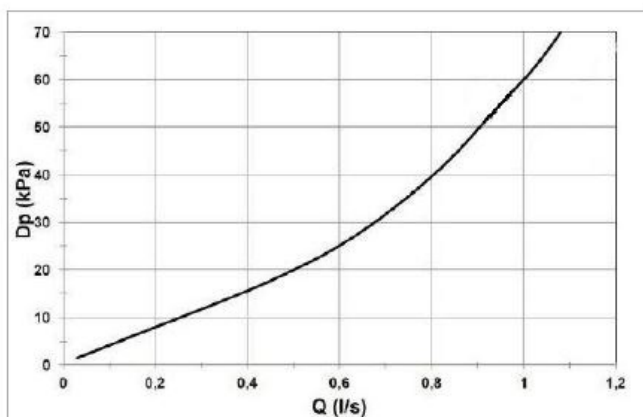

⚠ The solar integration for DHW excludes the configuration with an additional electrical heater, the external boiler connection kit and the hybrid solution.

KCCEX

External boiler connection kit

Kit offering the option to connect the water circuit to an external boiler.

The latter, to be provided by the customer, must have a clean ON/OFF contact.

The internal logics of SPHERA EVO 2.0 permit use of the boiler both together with or instead of the heat pump for greater comfort even at the coldest temperatures.

Kit composed of:

- 1 three-way valve with microswitch for ON/OFF activation of the boiler;
- copper pipes for connection;
- plastic seals;
- terminals and cables for electrical connections;
- kit installation manual.

⚠ The external boiler connection kit excludes configuration with additional electric heater.

⚠ Check that the boiler pressure drops are compatible with the head of the unit.

⚠ Check that the pressure drops of the boiler are compatible with the available pressure of the unit.

Accessories separately supplied

HID-TCXB **Black soft touch chronothermostat, with temperature control and management via App / Voice control**
HID-TCXN **White soft touch chronothermostat, with temperature control and management via App / Voice control**

For semi-uncased installation

Main functions available from the thermostat:

- ON/OFF
- keypad lock
- set-point control and limitation
- room temperature display
- setting change (manual / scheduled)
- antifreeze function (prevents temperatures that are too low)

Additional functions available on the Clivet Home Connect App

- weekly schedule
- boost (forced system switch-on)
- temperature and consumptions log

Technical specifications:

- display: colour soft-touch
- combinable SwitchConnect receivers: max 2
- installation: semi-uncased
- power supply: 100÷253V / 50÷60Hz
- settable temperature: 5÷40°C
- antifreeze temperature: 2÷25°C
- temperature offset: ±5°C (std 0°C)
- protection rating: IP30
- Wi-Fi: 802.11 b/g/n
- self-adjusting clock via web with back-up battery
- dimensions: 122x82x15mm



SWCX **SwitchConnect radio receiver**

Radio receiver for HID-TConnect, for managing the request of terminal units or radiant systems, the heat pump mode change or the double set-point.

Technical specifications:

- functions: radio receiver for use with HID-TConnect
- combinable thermostats: max 6
- frequency: 2.4GHz
- transmission distance: max 30m (in buildings) / max 100m (in open range)
- contacts: 2 relays (voltage-free)
- power supply: 95÷290V / 47÷440Hz
- operation temperature: 0÷40°C
- operation humidity: 20÷80% RH
- dimensions: 125x78x30.5mm



SFCSTX **Additional probe for cascade function**

Temperature sensor to manage the setpoint for units connected in cascade

Accessories separately supplied

DTX **Auxiliary drain pan**

Outdoor unit

The base plate of the outdoor unit is fitted with a drain for the condensate produced during the winter phase in the defrosting period. This can help (not guarantee) condensate flow correctly into the relevant drains.

To ensure the condensate is drained correctly, in the various operating conditions it is mandatory to use the auxiliary condensate drain pan with drainage to be connected to the drain trap, according to the relevant technical standards and regulations in force.

An anti-freeze heater is also included in the drain pan. It prevents the condensate produced from freezing when the outdoor temperature drops below zero.



APAVX **Kit of antivibration mounts for floor installation**

The antivibration mounts for floor installation reduce the vibrations of the compressor during its operation. They are secured to the feet of the base plate.



ASTFX **Kit of antivibration mounts for wall bracket installation**

The antivibration mounts reduce the vibrations of the compressor during its operation. They are secured to the wall support brackets.



KSIPX **Kit with wall fixing brackets**

Wall fixing bracket for outdoor unit, adjustable, in galvanised steel painted with polyester powders for outdoor use..

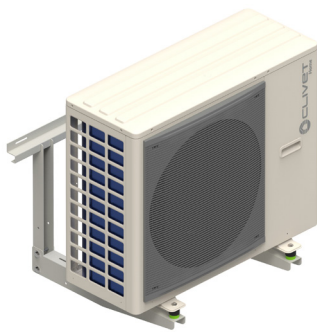

**HYSO24 -
HYSO34**

Hybrid solution with 24kW 4-pipe boiler

Hybrid solution with 34kW 4-pipe boiler

SPHERA EVO 2.0: hybrid version consisting of the SPHERA EVO 2.0 heat pump and boiler, designed to work simultaneously with or in replacement of each other.

The production of domestic hot water is guaranteed instantly by the boiler, which also allows simultaneous heating or cooling operation by the heat pump.

The kit includes:

- 24kW condensing boiler;
- 10 m long T1 temperature probe.

⚠ The hybrid solution excludes the additional heaters, the external boiler connection kit and the solar integration



KSDFX

Splitter for boiler smoke discharge

The KSDFX kit consists of a splitter (Ø 80/80) that can be connected to a boiler for air intake and smoke exhaust.

Connection to the flue must be made in compliance with the current technical regulations.

The unit is provided with a dedicated drain for the condensate coming from the boiler; this condensate with high acidity in residential use can be introduced in the waste water drain of the home (UNI 11071).

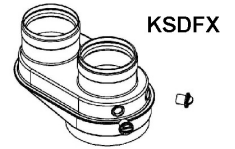

Split drain Ø 80/80
Accessory supplied separately

KCSAFX

Coaxial fitting for smoke discharge and intake (ø60/100)

Coaxial polypropylene flanged connection (ø60/100) for combustion gas discharge and air intake through two coaxial ducts..



**KITKX
KITAK50X**

Coaxial system for adjustable smoke discharge and intake (ø 60/100)

Coaxial system for adjustable smoke discharge and intake (ø 80/125)

It allows the combustion gases to be discharged and the air to be drawn in for the combustion stage by means of two coaxial ducts: the external one for the air intake, the internal one in plastic to discharge fumes.

- 60/100 mm diameter for HYSO24 boiler
- 80/125 mm diameter for HYSO34 boiler



KAS80X

Smoke intake and discharge fittings, 80 mm diameter

The boiler is supplied with flanged connections for discharge/intake (Ø 80).

The KAS80X kit consists of 2 fittings (Ø 80) for splitting the air intake and smoke exhaust directly from the boiler body.



KTCGPLX

Kit to convert boiler from methane to LPG

The boiler is supplied as STANDARD with methane gas operation.

To convert from methane gas to LPG, the accessory is supplied separately; its use will require recalibration following the instructions given in the documentation provided with the unit.

General technical data

Prestazioni

SIZE	2.1		3.1		4.1		5.1		6.1*	7.1*	8.1*		
STORAGE TANK CAPACITY	190 L	250 L	190 L	250 L	190 L	250 L	190 L	250 L	250 L	250 L	250 L		
Heating													
Air 7°C - Water 35°C													
Nominal heating capacity / Max	1	kW	4,32 / 6,26	6,18 / 7,41	8,30 / 9,11	10,09 / 10,3	12,13 / 14,60	14,51 / 15,5	16,01 / 16,80				
Total power input	1	kW	0,80	1,19	1,56	2,01	2,42	3,09	3,52				
COP	1	-	5,42	5,21	5,31	5,01	5,00	4,70	4,55				
Water flow-rate	1	l/s	0,21	0,30	0,41	0,49	0,57	0,67	0,75				
Nominal available pressure	1	kPa	31,2	36,5	33,1	31,0	25,7	31,7	22,6				
Maximum available pressure	1	kPa	69	95	62	90	47	83	31	76	70	55	39
Air -7°C - Water 35°C													
Nominal heating capacity / Max	2	kW	4,17 / 6,25	6,05 / 6,97	7,33 / 8,35	8,20 / 9,30	10,49 / 13,85	12,23 / 14,09	13,43 / 14,33				
Total power input	2	kW	1,32	2,01	2,27	2,67	3,36	4,33	4,90				
COP	2	-	3,16	3,00	3,23	3,07	3,13	2,82	2,74				
Water flow-rate	2	l/s	0,22	0,29	0,34	0,40	0,56	0,62	0,70				
Nominal available pressure	2	kPa	35,0	39,8	34,0	31,7	65,8	63,1	47,7				
Maximum available pressure	2	kPa	69	94	64	91	58	88	49	84	71	63	49
Air 7°C - Water 45°C													
Nominal heating capacity / Max	3	kW	4,16 / 5,96	6,03 / 7,13	8,22 / 8,98	10,01 / 10,30	12,30 / 14,50	14,00 / 15,70	16,01 / 16,60				
Total power input	3	kW	1,06	1,57	2,08	2,59	3,24	3,84	4,45				
COP	3	-	3,93	3,83	3,95	3,86	3,80	3,65	3,60				
Water flow-rate	3	l/s	0,19	0,30	0,39	0,49	0,60	0,67	0,76				
Nominal available pressure	3	kPa	32,3	36,4	34,9	31,0	51,6	41,8	21,7				
Maximum available pressure	3	kPa	70	95	63	90	51	85	31	76	65	55	38
Air 7°C - Water 55°C													
Nominal heating capacity / Max	4	kW	4,08 / 5,74	5,94 / 6,90	7,50 / 7,80	9,60 / 9,72	12,07 / 13,90	13,85 / 14,50	13,85 / 14,50				
Total power input	4	kW	1,36	1,93	2,35	3,10	3,89	4,53	5,52				
COP	4	-	3,00	3,07	3,19	3,10	3,10	3,05	2,90				
Water flow-rate	4	l/s	0,12	0,18	0,23	0,29	0,36	0,41	0,48				
Nominal available pressure	4	kPa	35,6	33,4	31,2	33,6	14,1	16,5	17,4				
Maximum available pressure	4	kPa	70	98	70	96	69	94	63	91	90	105	80
Cooling													
Air 35°C - Water 18°C													
Nominal cooling capacity / max	5	kW	4,55 / 6,88	6,44 / 7,65	8,10 / 11,13	10,00 / 12,03	12,06 / 15,02	13,79 / 15,30	14,84 / 16,38				
Total power input	5	kW	0,75	1,23	1,58	2,10	3,00	3,73	4,07				
EER	5	-	6,08	5,24	5,12	4,77	4,02	3,70	3,65				
Water flow-rate	5	l/s	0,22	0,32	0,38	0,48	0,60	0,63	0,71				
Nominal available pressure	5	kPa	34,9	34,8	34,6	10,6	13,1	16,3	15,1				
Maximum available pressure	5	kPa	69	94	61	89	51	85	32	76	65	61	48
Air 35°C - Water 7°C													
Nominal cooling capacity / max	6	kW	4,26 / 6,14	6,25 / 6,39	7,46 / 7,94	9,10 / 8,67	11,80 / 11,16	12,86 / 11,72	14,2 / 12,88				
Total power input	6	kW	1,22	2,02	2,24	2,94	4,29	5,04	5,80				
EER	6	-	3,50	3,09	3,33	3,09	2,75	2,55	2,45				
Water flow-rate	6	l/s	0,20	0,29	0,36	0,43	0,54	0,59	0,64				
Nominal available pressure	6	kPa	5,8	36,1	34,3	36,8	18,1	20,3	25,1				
Maximum available pressure	6	kPa	70	95	64	91	56	87	43	82	74	67	60

1. User side entering/leaving water temperature 30/35 °C, source side air 7°C (U.R. = 85% Heat power data, Total power input and COP in accordance with EN 14511:2018.
2. User side entering/leaving water temperature 30/35 °C, source side air -7°C Heat power data, Total power input and COP in accordance with EN 14511:2018.
3. User side entering/leaving water temperature 40/45 °C, source side air 7°C (U.R. = 85% Heat power data, Total power input and COP in accordance with EN 14511:2018.
4. User side entering/leaving water temperature 18/23 °C, source side air 35°C Heat power data, Total power input and COP in accordance with EN 14511:2018.
5. User side entering/leaving water temperature 7/12 °C, source side air 35°C Heat power data, Total power input and COP in accordance with EN 14511:2018.
6. The product is conforming with the European ErP Directives, which includes Commission Delegated Regulation (EU) N. 811/2018 and Commission Delegated Regulation N. 813/2013, Clima Average, High Temperature 47/55°C.

All data calculated with zero elevation gain and equivalent length of 7m.

SIZE			2.1		3.1		4.1		5.1		6.1*		7.1*		8.1*	
STORAGE TANK CAPACITY			190 L	250 L	190 L	250 L	190 L	250 L	190 L	250 L	250 L	250 L	250 L	250 L	250 L	250 L
ERP																
Clima Average High temperature Heat pumps																
Nominal power	7	kW	4		6		7		9		12		13		13	
SCOP	7	-	3.32		3.54		3.72		3.73		3.56		3.52		3.48	
Generator energy class	7	-	A++		A++		A++		A++		A++		A++		A++	
η_s	7	%	130		138		146		146		139		138		136	
System energy class	7	-	A++		A++		A++		A++		A++		A++		A++	
η_s	7	%	135		143		151		151		144		143		141	
Clima Average Low temperature Heat pumps																
Nominal power	8	kW	5		6		8		10		12		14		16	
SCOP	8	-	5,13		5,15		5.32		5.27		5.00		4.91		4.89	
Generator energy class	8	-	A+++		A+++		A+++		A+++		A+++		A+++		A+++	
η_s	8	%	202		203		210		208		196		193		193	
System energy class	8	-	A+++		A+++		A+++		A+++		A+++		A+++		A+++	
η_s	8	%	207		208		215		213		201		198		198	
Average climatic conditions - Heat pump for application with Fan coil																
Nominal power	9	kW	4		6		7		9		12		13		14	
SEER	9	-	5,09		5,42		5.95		6.01		5.16		5.10		4.87	
Generator energy class	9	-	A+++		A+++		A+++		A+++		A+++		A+++		A+++	
η_s	9	%	201		214		235		238		203		201		192	
Heat pump for Domestic Hot Water application																
Load profile declared	10	-	L	XL	L	XL	L	XL	L	XL	XL	XL	XL	XL	XL	XL
η_{wh}	10	%	120	123	120	123	116	125	116	125	124	124	124	124	124	124
Sanitary water energy class	10	-	A+	A+	A+	A+	A+	A+	A+	A+	A+	A+	A+	A+	A+	A+

- The product is conforming with the European ErP Directives, which includes Commission Delegated Regulation (EU) N. 811/2018 and Commission Delegated Regulation N. 813/2013. Clima Average, Medium temperature 47/55°C
- The product is conforming with the European ErP Directives, which includes Commission Delegated Regulation (EU) N. 811/2018 and Commission Delegated Regulation N. 813/2013. Clima Average, Low temperature 30/35°C
- The product is conforming with the European ErP Directives, which includes Commission Delegated Regulation (EU) N. 811/2018 and Commission Delegated Regulation N. 813/2013. Clima Average, Low temperature 12/7°C
- Dati secondo EN 16147:2017

All data calculated with zero elevation gain and equivalent length of 7m..

Construction - Outdoor unit

SIZE			2.1		3.1		4.1		5.1		6.1		7.1		8.1	
Characteristics																
Compressor	Twin Rotary															
Refrigerant	R32															
Refrigerant charge	kg	1.50	1.50	1.65	1.65	1.84	1.84	1.84	1.84	1.84	1.84	1.84	1.84	1.84	1.84	1.84
GWP	t_{CO_2}	675	675	675	675	675	675	675	675	675	675	675	675	675	675	675
Equivalent tons of CO2 (*)	t_e	1.02	1.02	1.11	1.11	1.24	1.24	1.24	1.24	1.24	1.24	1.24	1.24	1.24	1.24	1.24
Oil charge	l	0,46	0,46	0,46	0,46	1,10	1,10	1,10	1,10	1,10	1,10	1,10	1,10	1,10	1,10	1,10
Type of fan	Axial															
Nominal air flow rate	m^3/h	2770	2770	4030	4030	4060	4060	4060	4060	4060	4060	4060	4060	4060	4060	4060
Outdoors unit sound pressure at 1 metre	1 dB(A)	42	44	45	47	50	51	53	53	53	53	53	53	53	53	53
Sound power	1 dB(A)	55	57	58	60	63	64	66	66	66	66	66	66	66	66	66
Dimensions																
Operation (L x P x A)	mm	1008x426x712	1008x426x712	1118x523x865	1118x523x865	1118x523x865	1118x523x865	1118x523x865	1118x523x865	1118x523x865	1118x523x865	1118x523x865	1118x523x865	1118x523x865	1118x523x865	1118x523x865
Packing (L x P x A)	mm	1065x485x800	1065x485x800	1180x560x890	1180x560x890	1180x560x890	1180x560x890	1180x560x890	1180x560x890	1180x560x890	1180x560x890	1180x560x890	1180x560x890	1180x560x890	1180x560x890	1180x560x890
Operation weight 230M / 400TN	2 kg	58	58	77	77	96/112	96/112	96/112	96/112	96/112	96/112	96/112	96/112	96/112	96/112	96/112
Shipping weight 230M / 400TN	2 kg	64	64	88	88	110/125	110/125	110/125	110/125	110/125	110/125	110/125	110/125	110/125	110/125	110/125

- Sound pressure level determined using the intense metric method (UNI EN ISO 9614-2). The sound levels are referred to a unit at full load, under nominal test conditions. Data referred to the following conditions: service side exchanger inlet/outlet water 47/55 °C source side exchanger inlet air 7°C. The sound pressure level refers to a distance of 1 m from the external surface of the unit operating in the free field.
 - Power supply 220-240V ~ 50Hz / Power supply 380-415V 3N~ 50Hz
- (*) It contains fluorinated greenhouse gases.

General technical data

Construction - Indoor unit

SIZE			A - 190 L	A - 250 L	B - 250 L
System characteristics					
Maximum circuit pressure		bar	3,0	3,0	3,0
System expansion tank	1	l	8,0	8,0	8,0
Preload expansion tank		bar	1,0	1,0	1,0
System water connections		inch	1"	1"	1"
DHW characteristics					
Type Storage tank			Enameled steel	Enameled steel	Enameled steel
Volume of DHW tank		l	190	250	250
Internal pipe coil exchange surface		m ²	2,0	2,0	2,0
Storage dispersion		W/K (kWh/24h)	1.81 (1.95)	2.04 (2.20)	2.04 (2.20)
DHW safety heating element		kW	2,0	2,0	2,0
Maximum DHW circuit pressure	2	bar	10,0	10,0	10,0
Recommended sanitary expansion tank	3	l	12,0	16,0	16,0
DHW water connections		inch	3/4"	3/4"	3/4"
Dimensions					
Operation (L x P x A)		mm	600 x 615 x 1774	600 x 615 x 2084	600 x 615 x 2084
Packing (L x P x A)		mm	660 x 690 x 1890	660 x 690 x 2190	660 x 690 x 2190
Operation weight		kg	359	419	421
Shipping weight		kg	187	192	194

1. Sufficient volume up to a maximum of 60 litres of system water content.
2. The installation of the sanitary side safety valve is mandatory and left to the installer.
3. The installation of the fixture's expansion tank is mandatory and is to be completed by the installer. The indicated volumes are for reference purposes only..

Configuration compatibility table SPHERA EVO 2.0 Tower

INDOOR UNIT	SQKN-YEE 1 TC A							SQKN-YEE 1 TC B		INTEGRATION ELECTRIC HEATER		
	Storage	190L	250L	250L	250L	EH024	EH3	EH6	EH9			
OUTDOOR UNIT												
MiSAN-YEE 1 S 2.1	✓	✓	-	✓	✓	✓	✓	✓	✓			
MiSAN-YEE 1 S 3.1	✓	✓	-	✓	✓	✓	✓	✓	✓			
MiSAN-YEE 1 S 4.1	✓	✓	-	✓	✓	✓	✓	✓	✓			
MiSAN-YEE 1 S 5.1	✓	✓	-	✓	✓	✓	✓	✓	✓			
MiSAN-YEE 1 S 6.1	-	-	✓	✓	✓	✓	✓	✓	✓			
MiSAN-YEE 1 S 7.1	-	-	✓	✓	✓	✓	✓	✓	✓			
MiSAN-YEE 1 S 8.1	-	-	✓	✓	✓	✓	✓	✓	✓			

Condensing boiler technical data

Boiler model		R2K 24	R2K 34
Max. nominal heat capacity for heating	kW	23,5	34,0
Max. nominal heat capacity for domestic hot water	kW	23,5	34,0
Minimum nominal heat capacity	kW	2,9	4,1
Available nominal heating capacity 60/80°C	kW	22,7	33,4
Available minimum nominal heating capacity 60/80°C	kW	-	3,9
Available nominal heating capacity 30/50°C	kW	24,8	36,2
Available nominal heat yield 60/80°C	%	96,6	98,1
Available nominal heat yield 30/50°C	%	105,5	106,4
Partial load heat yield 30%	%	107,5	108,6
Seasonal environment heating energy efficiency η_s	%	91	93
Domestic hot water energy class	-	A	A
Declared load profile	-	XL	XL
Specific capacity in continuous service Δt 30°C	l/ min	11,5	16
Water heating energy efficiency η_h	%	81	83
Chimney losses with burner ON at nom Pow	%	2,6	2,4
Chimney losses with burner ON at min Pow	%	2,2	2,1
Chimney losses with burner OFF	%	0,015	0,01
Casing losses with burner ON at nom Pow	%	1	0,48
Casing losses with burner ON at min Pow	%	-	1,84
Casing losses with burner OFF	%	-	0,035
Smoke temperature at nominal heat capacity	°C	73,7	69,4
NOx Class	classe	6	6
Auxiliary electricity consumption at full load	kW	0,04	0,04
Auxiliary electricity consumption at partial load	kW	0,02	0,02
Sound power level	dB	52	52
Width	mm	410	410
Depth	mm	307	350
Height	mm	642	642
Shipping weight	kg	35	44

Hydraulic data - Indoor unit + Outdoor unit

SIZE			2.1		3.1		4.1		5.1		6.1		7.1		8.1	
			190 L	250 L	190 L	250 L	190 L	250 L	190 L	250 L	250 L	250 L	250 L	250 L	250 L	250 L
Characteristics																
Minimum system water content	1	l	15		22		28		35		60		60		60	
Minimum admitted water flow rate		l/s	0,16		0,16		0,16		0,16		0,16		0,16		0,16	
Maximum admitted water flow rate		l/s	0,61	0,86	0,61	0,86	0,61	0,86	0,61	0,86	0,92	0,92	0,92	0,92	0,92	0,92
Net boiler capacity		l	182	240	182	240	182	240	182	240	240	240	240	240	240	240
DHW tank setpoint		°C	50	50	50	50	50	50	50	50	50	50	50	50	50	50
Water mixed at 40°C (V40)		l	204	269	204	269	204	269	204	269	269	269	269	269	269	269
Warm-up time	2	h:min	02:30	02:25	02:30	02:25	02:08	02:05	02:08	02:05	01:46	01:46	01:46	01:46	01:46	01:46
Energy consumption during heating	3	kWh	2,20	2,70	2,20	2,70	2,30	2,85	2,30	2,85	3,01	3,01	3,01	3,01	3,01	3,01

1. Consider the water content of the area with less volume
2. Time required to bring the water volume of the tank from a temperature of 10°C to a temperature of 50°C
3. Energy consumption to bring the water volume of the tank from a temperature of 10°C to a temperature of 50°C

General technical data

Electrical data

Outdoor unit

SIZE		2.1	3.1	4.1	5.1	6.1	7.1	8.1
Power supply 220-240V ~ 50Hz								
F.L.A. - Full load current at max admissible conditions	A	10.0	11.8	15.0	16.4	24.5	25.9	27.7
F.L.I. - Full load power input at max admissible conditions	kW	2.20	2.60	3.30	3.60	5.40	5.70	6.10
M.I.C - Maximum inrush current	A	10.0	11.8	16.7	16.4	24.5	25.9	27.7
Power supply 380-415V 3N~ 50Hz								
F.L.A. - Full load current at max admissible conditions	A	-	-	-	-	8.20	8.70	9.30
F.L.I. - Full load power input at max admissible conditions	kW	-	-	-	-	5.40	5.70	6.10
M.I.C - Maximum inrush current	A	-	-	-	-	8.20	8.70	9.30

Indoor unit

SIZE		A - 190 L	A - 250 L	B - 250 L
Power supply 220-240V ~ 50Hz				
F.L.A. - Current draw without DHW heating element	A	0,50	0,90	0,90
F.L.A. - Current draw of DHW heating element	A	8,70	8,70	8,70
F.L.A. - TOTAL current draw under maximum conditions	A	9,20	9,60	9,60
F.L.I. - Power draw without DHW heating element	kW	0,10	0,20	0,20
F.L.I. - Power draw of DHW heating element	kW	2,00	2,00	2,00
F.L.I. - Total power draw under full load	kW	2,10	2,20	2,20
M.I.C. - Maximum inrush current of unit	A	9,20	9,60	9,60

Power supply 220-240V ~ 50Hz +/-10%

The units are conforming with the prescriptions of European Standards CEI EN 60335

(*) All data calculated with zero height difference and a length of 7m.

! Important: when rating the unit, check that the absorptions are conforming to the utility contract in the country of installation

2 zones external kit

INDOOR UNIT 220-240V ~ 50HZ

Power supply		220-240V ~ 50Hz
F.L.A. - Full load current at max admissible conditions	A	0,45
F.L.I. - Full load power input at max admissible conditions	kW	0,10

Power supply 220-240V ~ 50Hz +/-10%.

The units are conforming with the prescriptions of European Standards CEI EN 60335.

Auxiliary condensate collection tray

INDOOR UNIT 220-240V ~ 50HZ

Power supply		220-240V ~ 50Hz
F.L.A. - Full load current at max admissible conditions	A	0,40
F.L.I. - Full load power input at max admissible conditions	kW	0,08

Power supply 220-240V ~ 50Hz +/-10%.

The units are conforming with the prescriptions of European Standards CEI EN 60335.

Additional electric heater - EH024/EH3/EH6/EH9

SIZE		2 kW	3 kW	4 kW
Power supply 220-240V ~50Hz				
F.L.A. - Full load current at max admissible conditions	A	8,70	13,1	17,4
F.L.I. - Full load power input at max admissible conditions	kW	2,00	3,00	4,00

Power supply 220-240V ~50Hz +/- 10%
 Size 2kW and 4kW available only for indoor unit A, size 3kW available only for indoor unit B

SIZE		6 kW	9 kW
Power supply 380-415V 3N ~50Hz			
F.L.A. - Full load current at max admissible conditions	A	8,60	13,0
F.L.I. - Full load power input at max admissible conditions	kW	6,00	9,00

Power supply 380-415V 3N ~50Hz +/- 6%.
 Data to be added to the values of the standard unit without DHW electric heater.

⚠ The additional electric heater is not an accessory supplied separately, but a construction configuration.

General technical data

Sound levels outdoor unit

Standard mode

SIZE	Sound power level								Sound pressure level	Sound power level
	Octave band (Hz)									
	63	125	250	500	1000	2000	4000	8000	dB(A)	dB(A)
2.1	46	49	49	52	52	46	37	27	42	55
3.1	49	48	50	55	53	48	39	30	44	57
4.1	36	51	53	56	55	49	44	30	45	58
5.1	37	56	53	57	57	51	47	36	47	60
6.1	44	53	54	60	58	55	52	51	50	63
7.1	44	54	55	60	59	57	56	54	51	64
8.1	46	58	57	60	61	59	54	51	53	66

Sound levels refer to units with full load under nominal test conditions. Data referred to the following conditions: entering / leaving exchanger water temperature user side 47/55°C source side exchanger air inlet 7°C.
The sound pressure level refers to a distance of 1m from the external surface of the units operating in an open field.
Noise levels are determined using the tensiometric method (UNI EN ISO 9614-2).

Silenced mode

SIZE	Sound pressure level	Sound power level
	dB(A)	dB(A)
2.1	40	53
3.1	40	53
4.1	42	55
5.1	42	55
6.1	46	59
7.1	47	60
8.1	48	61

Sound levels refer to units with full load under nominal test conditions.
For maximum capacity delivered in silent mode use a correction factor of 0.8.
Data referred to the following conditions: entering / leaving exchanger water temperature user side 47/55°C source side exchanger air inlet 7°C.
The sound pressure level refers to a distance of 1m from the external surface of the units operating in an open field.
Noise levels are determined using the tensiometric method (UNI EN ISO 9614-2).

Super-silenced mode

SIZE	Sound pressure level	Sound power level
	dB(A)	dB(A)
2.1	37	50
3.1	38	51
4.1	39	52
5.1	39	52
6.1	41	54
7.1	41	54
8.1	41	54

Sound levels refer to units with full load under nominal test conditions.
For maximum capacity delivered in silent mode use a correction factor of 0,6
Data referred to the following conditions: entering / leaving exchanger water temperature user side 47/55°C source side exchanger air inlet 7°C.
The sound pressure level refers to a distance of 1m from the external surface of the units operating in an open field.
Noise levels are determined using the tensiometric method (UNI EN ISO 9614-2).

Operating limits

Cooling

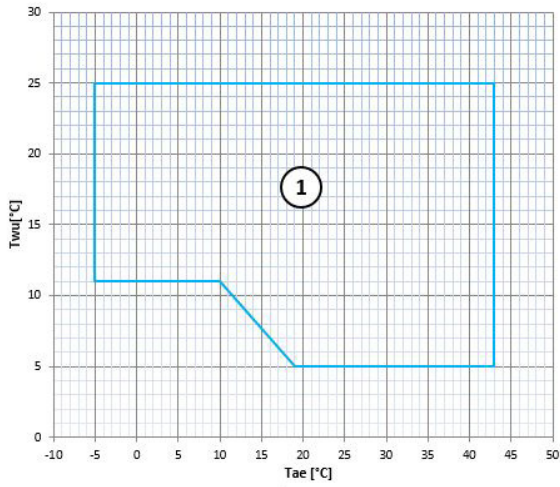

T_{wout} [°C] = Exchanger water outlet temperature
 T_{ae} [°C] = Outdoors exchanger air inlet temperature

1. Normal operating range

Heating

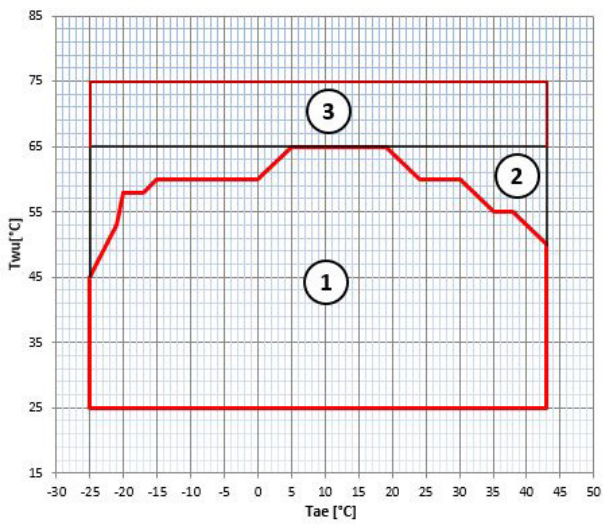

T_{wout} [°C] = Exchanger water outlet temperature
 T_{ae} [°C] = Outdoors exchanger air inlet temperature

1. Normal operating range
2. Operating range with additional electric heater option
3. Hybrid system operating range

In the configuration with the integration electric heater, the extension of the limits varies according to the electrical capacity of the electric heater chosen.

General technical data

Performance curves in domestic hot water production

Curves referring to the switch-on of the unit from which 90 litres of water were taken out of a total of about 190 available (at an equivalent temperature of 40°C).

Heating time

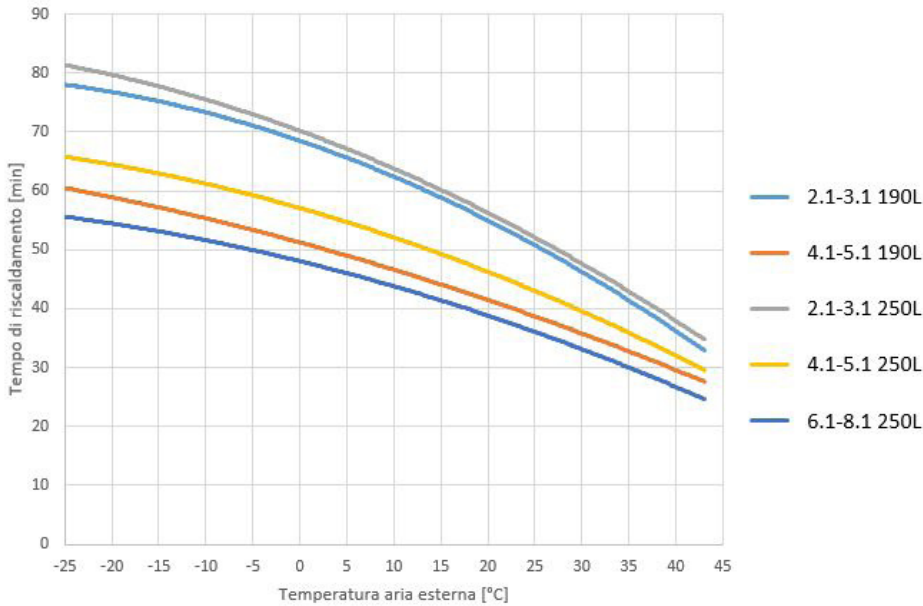

Energy consumption

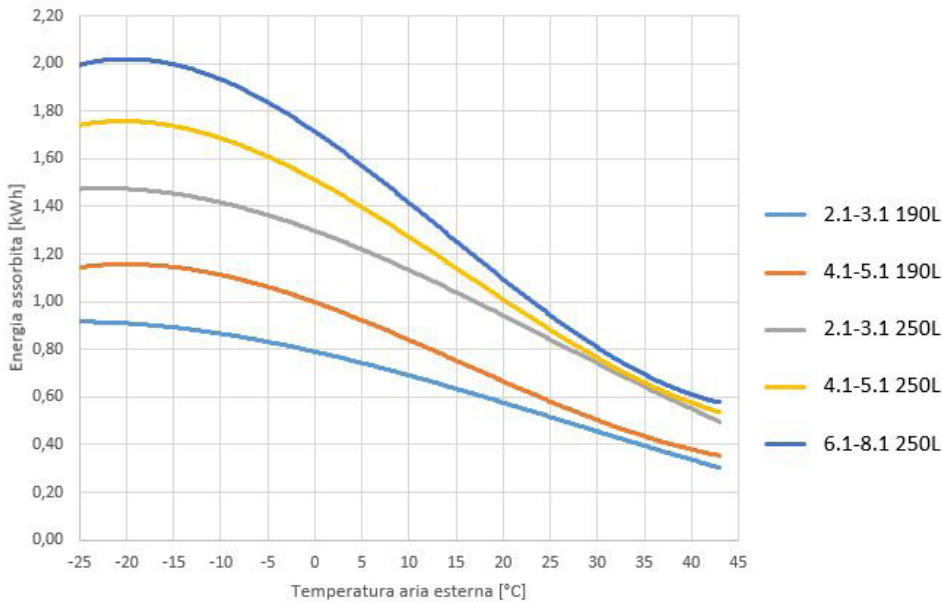

Nominal test conditions:

- Storage temperature (T5) at power-off = 50°C
- Storage temperature (T5) at switch-on = 40°C
- Amount drawn = 3 l/min

Available pressure of the standard circulator at the unit 190 L A connections

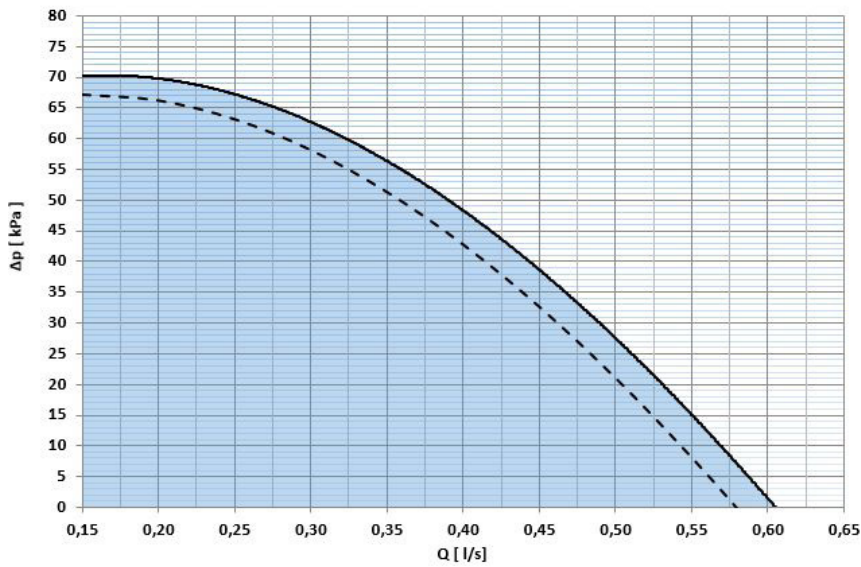

ΔP [kPa] = Available pressure
 Q [l/s] = Water flow-rate

----- Maximum head of the circulator with configuration of integration electric heater
 Circulator operating field

Absorption of the standard circulator at the unit 190 L - A

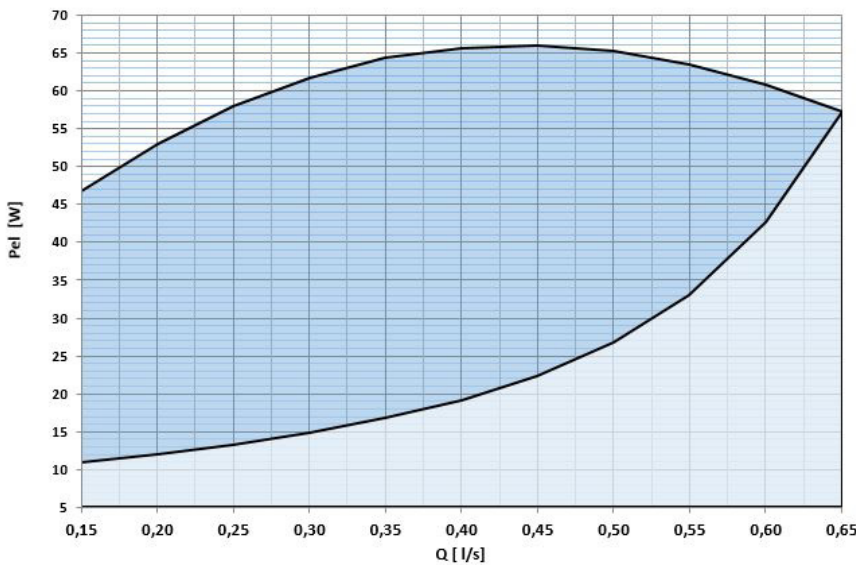

P_{el} [W] = Electrical power input
 Q [l/s] = Water flow-rate

Circulator operating field

General technical data

Available pressure of the standard circulator at the unit 250 L A connections

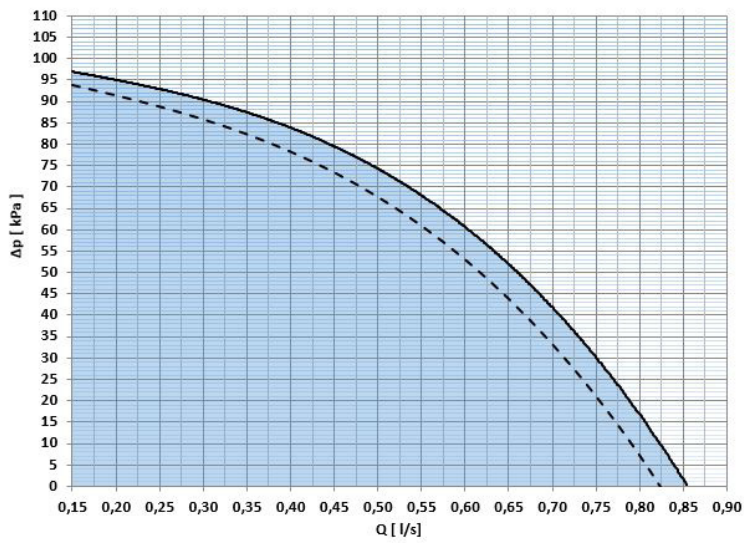

ΔP [kPa] = Available pressure
Q [l/s] = Water flow-rate

----- Maximum head of the circulator with configuration of integration electric heater
 Circulator operating field

Absorption of the standard circulator at the unit 250 L - A

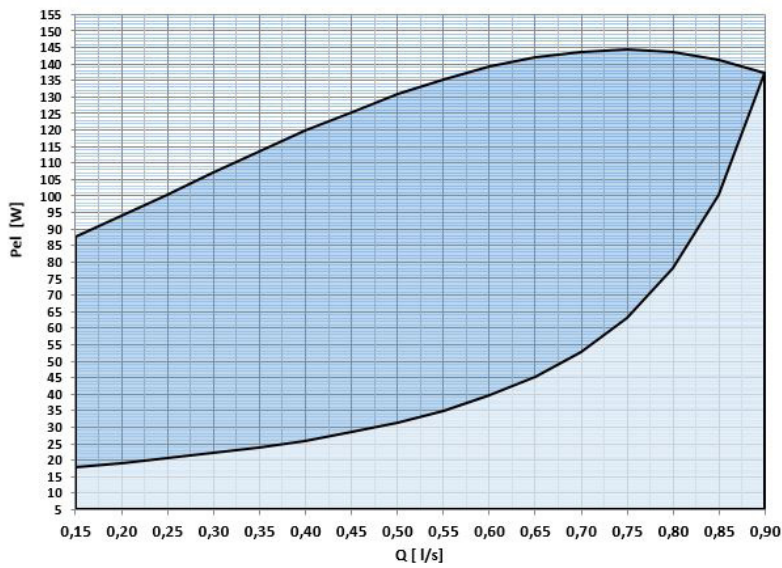

Pel [W] = Electrical power input
Q [l/s] = Water flow-rate

Circulator operating field

Available pressure of the standard circulator at the unit 250 L B connections

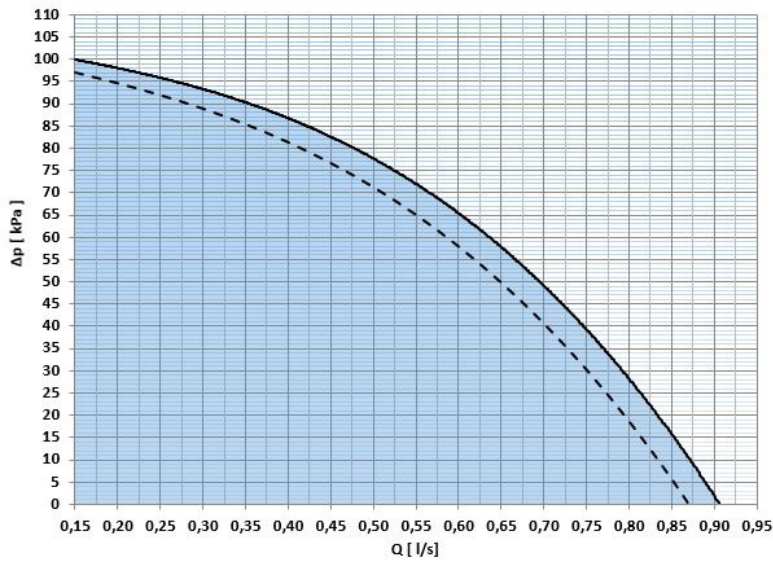

ΔP [kPa] = Available pressure
 Q [l/s] = Water flow-rate

----- Maximum head of the circulator with configuration of integration electric heater.
 ■ Circulator operating field

Absorption of the standard unit 250 L - B

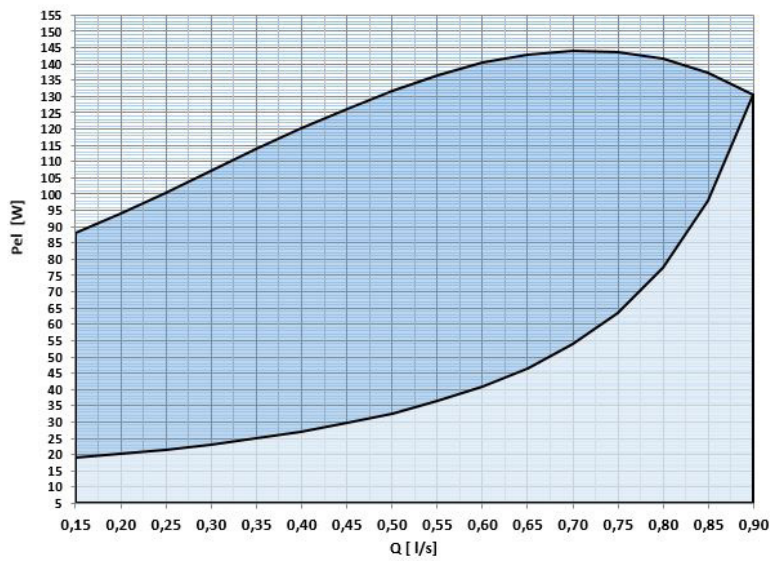

P_{el} [W] = Electrical power input
 Q [l/s] = Water flow-rate

■ Circulator operating field

Pressure drop for direct booster system circulator

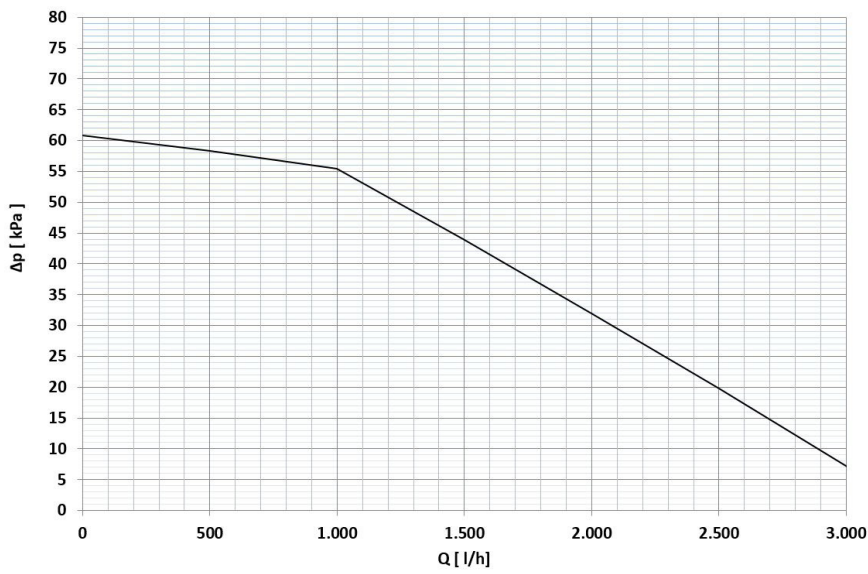

ΔP [kPa] = Available pressure

Q [l/h] = Water flow-rate

Available head for mixed booster system circulator

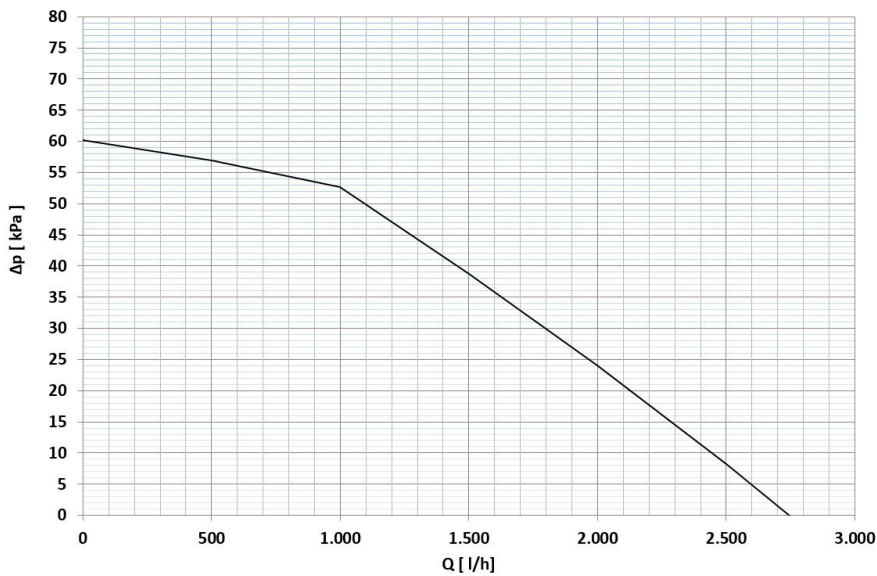

P_{el} [W] = Electrical power input

Q [l/h] = Water flow-rate

Sizing the refrigerant pipes

Equivalent length of pipes (metres) = Effective length (metres) +
Number of bends x K

Consider K= 0.3 m per wide radius elbow bend.
Consider K= 0.5 m per standard 90° elbow bend.

⚠ to correctly install the refrigerant pipes and charge the refrigerant gas, refer to the SPHERA MANUAL

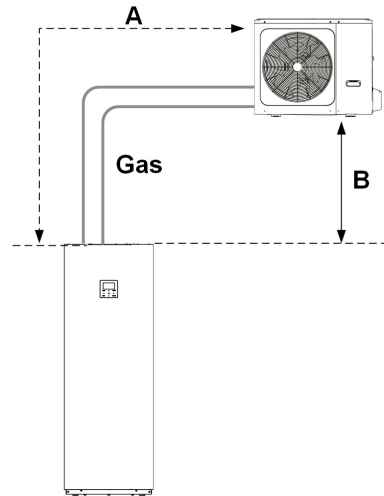

SIZE		2.1	3.1	4.1	5.1	6.1	7.1	8.1
Length and height difference of refrigerant pipes								
A - Refrigerant pipe min/max equivalent length	m	2 - 30	2 - 30	2 - 30	2 - 30	2 - 30	2 - 30	2 - 30
C - Maximum refrigerant pipe height difference with outdoors unit higher than indoors unit	m	25	25	25	25	25	25	25
C - Maximum refrigerant pipe height difference with outdoors unit higher than indoors unit	m	25	25	25	25	25	25	25
Diameters of refrigerant pipes								
Gas pipe diameter	inch	5/8"	5/8"	5/8"	5/8"	5/8"	5/8"	5/8"
Fluid line diameter	inch	1/4"	1/4"	3/8"	3/8"	3/8"	3/8"	3/8"
Additional charge per meter	kg/m	0,020	0,020	0,038	0,038	0,038	0,038	0,038

Determination of cooling and heating power loss

The equivalent length of the cooling lines results in a loss of cooling and heating power supplied to the circuit and DHW system. The graph shows the amount of this loss of powergh

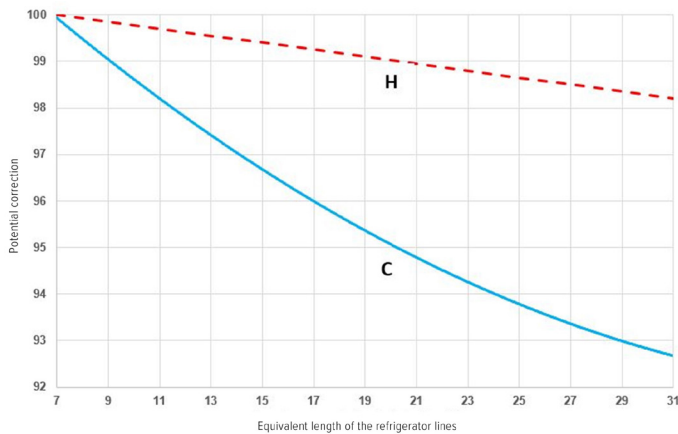

C = Cooling power efficiency curve
H = Heating power efficiency curve

Water connections

Here are some diagrams of system connections provided as an indication. The connection and design of the system must be carried out in accordance with national regulations in force.

The diagrams do not report the mandatory components to be taken care of by the customer.

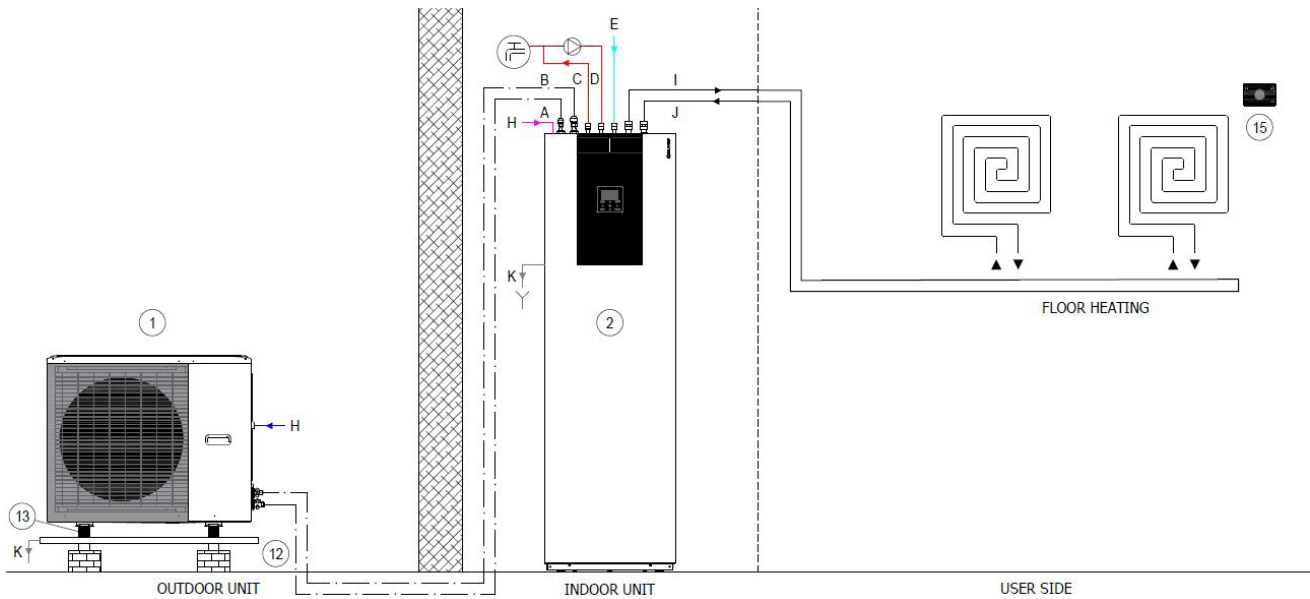

1. Outdoor unit
2. Indoor unit
3. 2 zone kit (KIRE2HX-KIRE2hXL)
4. Single zone kit (KCSX)
5. Integration electric heater (EH024 - EH3 - EH6 - EH9)
6. Integrazione solare per sanitario (SOLX) --> solo nel tower
7. Solar panel
8. Hybrid solution (HYSO24 - HYSO34)
9. 40L inertial storage tank (ACI40X)
10. 1-litre circuit breaker (DIX)
11. 50-litre circuit breaker- 60L inertial storage tank (DI50X - ACI60X)
12. Condensate drain pan (DTX)
13. Anti-vibration mount (APAVX - ASTFX)
14. Brackets wall (KSIPX)
15. Chronothermostat (HID-TCXB - HID-TCXN)
16. DHW storage (ACS200X - ACS300X - ACS500X + SCS08X - SCS12X)
17. ElfoControl³ EVO

- A. Liquid line
- B. Gas line
- C. DHW outlet
- D. Ingresso ricircolo ACS
- E. Aqueduct inlet
- F. Solar outlet
- G. Solar inlet
- H. Power input
- I. System return
- J. System supply
- K. Condensate drain

220-240V~50Hz
380-415V 3N ~50HZ con EH3 - EH6 - EH9

2.1 - 5.1 single phase 220-240V ~50Hz
6.1 - 8.1 single phase 220-240V ~50Hz
6.1 - 8.1 three-phase 380415V 3N~50Hz

BUS RS 485
Technical water
Domestic cold water
Domestic hot water
Condensate drain

Electrical connections

The electrical hookup must be conforming with the local regulations. The hookup must be done by a specialised technician, qualified to work on live equipment.

SPHERA EVO 2.0 can be controlled with the on-board controller. To operate the unit, you may use: the ELFOControl³ EVO supervision system or normal electromechanical thermostats.

For more information on connections, consult the installation manual.

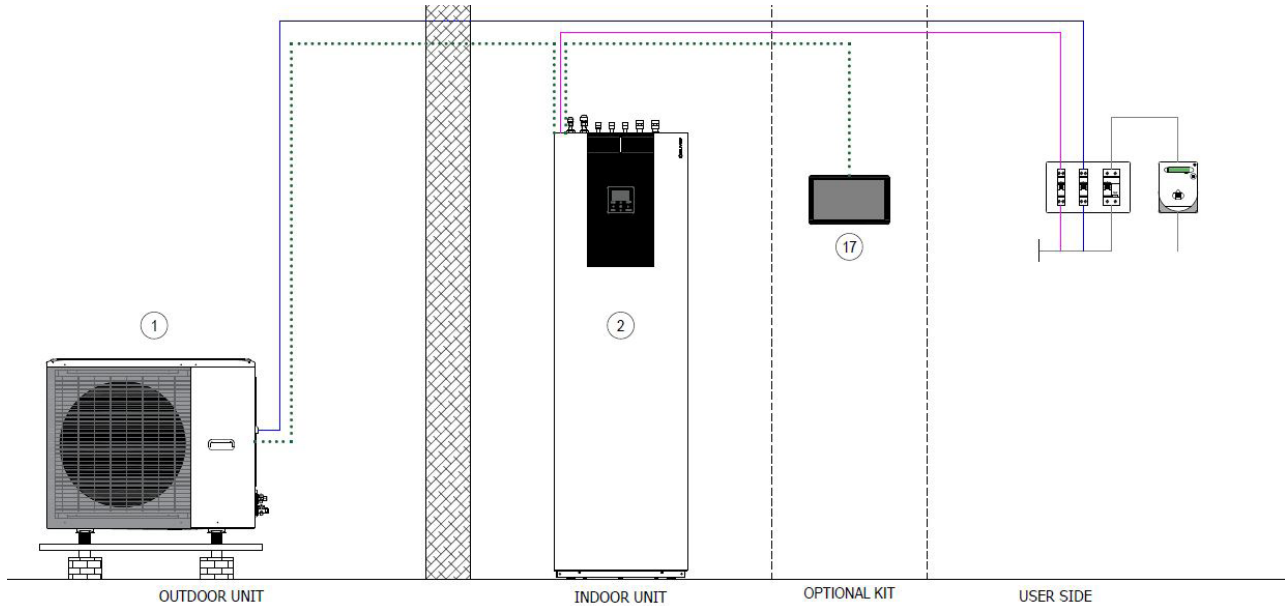

1. Outdoor unit
2. Indoor unit
3. 2 zone kit (KIRE2HX-KIRE2hXL)
4. Single zone kit (KCSX)
5. Integration electric heater (EH024 - EH3 - EH6 - EH9)
6. Integrazione solare per sanitario (SOLX) --> solo nel tower
7. Solar panel
8. Hybrid solution (HYSO24 - HYSO34)
9. 40L inertial storage tank (ACI40X)
10. 1-litre circuit breaker (DIX)
11. 50-litre circuit breaker- 60L inertial storage tank (DI50X - ACI60X)
12. Condensate drain pan (DTX)
13. Anti-vibration mount (APAVX - ASTFX)
14. Brackets wall (KSIPX)
15. Chronothermostat (HID-TCXB - HID-TCXN)
16. DHW storage (ACS200X- ACS300X - ACS500X + SCS08X - SCS12X)
17. ElfoControl³ EVO

- A. Liquid line
- B. Gas line
- C. DHW outlet
- D. Ingresso ricircolo ACS
- E. Aqueduct inlet
- F. Solar outlet
- G. Solar inlet
- H. Power input
- I. System return
- J. System supply
- K. Condensate drain

- 220-240V~50Hz
- 380-415V 3N ~50HZ con EH3 - EH6 - EH9
- 2.1 - 5.1 single phase 220-240V ~50Hz
- 6.1 - 8.1 single phase 220-240V ~50Hz
- 6.1 - 8.1 three-phase 380415V 3N~50Hz
- BUS RS 485
- Technical water
- Domestic cold water
- Domestic hot water
- Condensate drain

System connections

General description of the system and possible connections

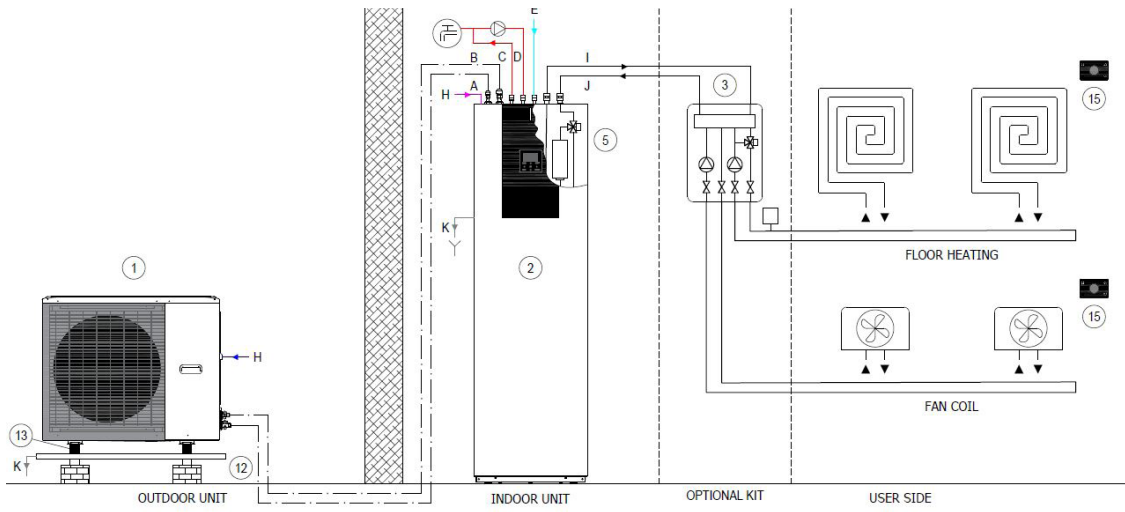

Additional electric heater

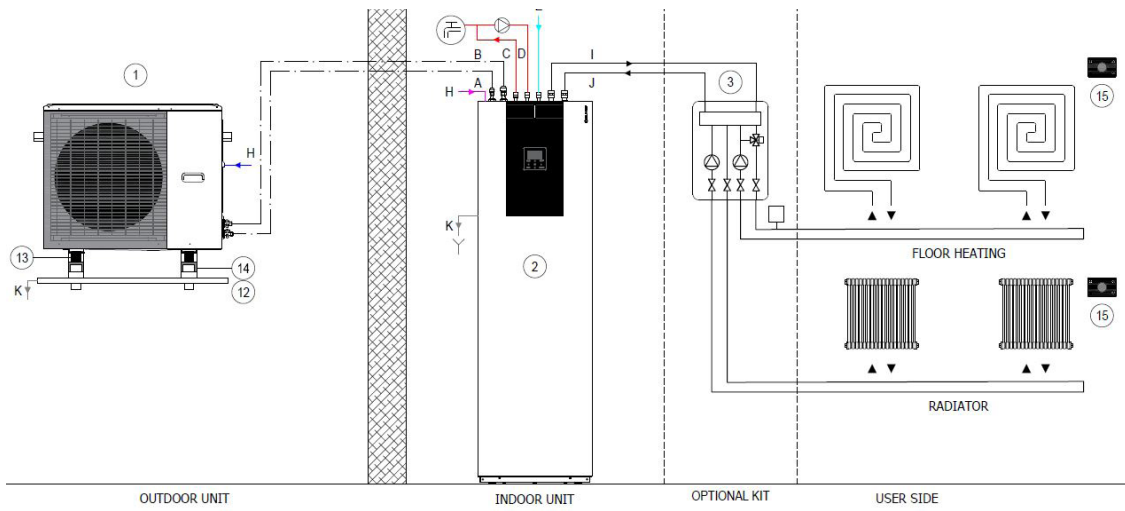

2 zone kit

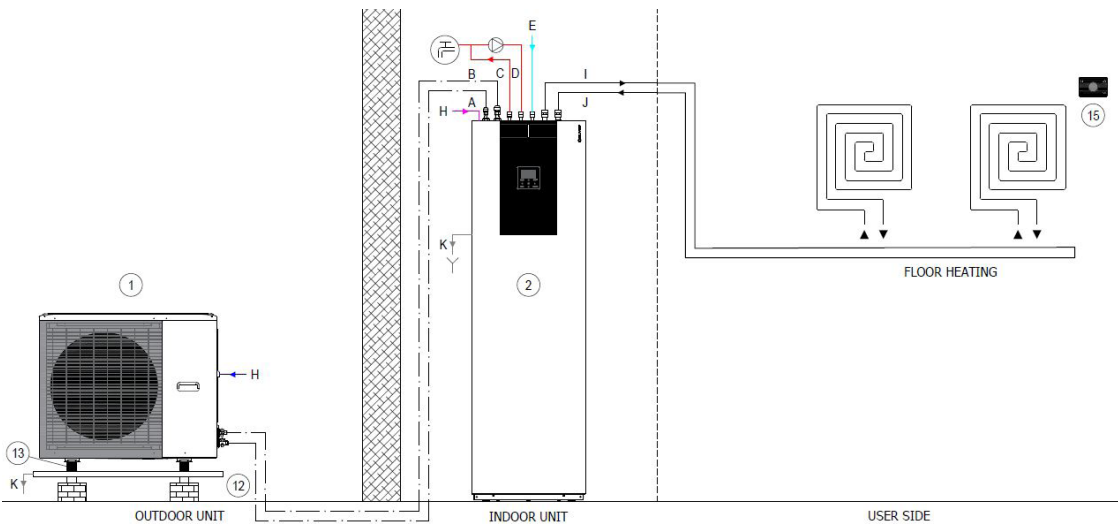

Single zone

General description of the system and possible connections

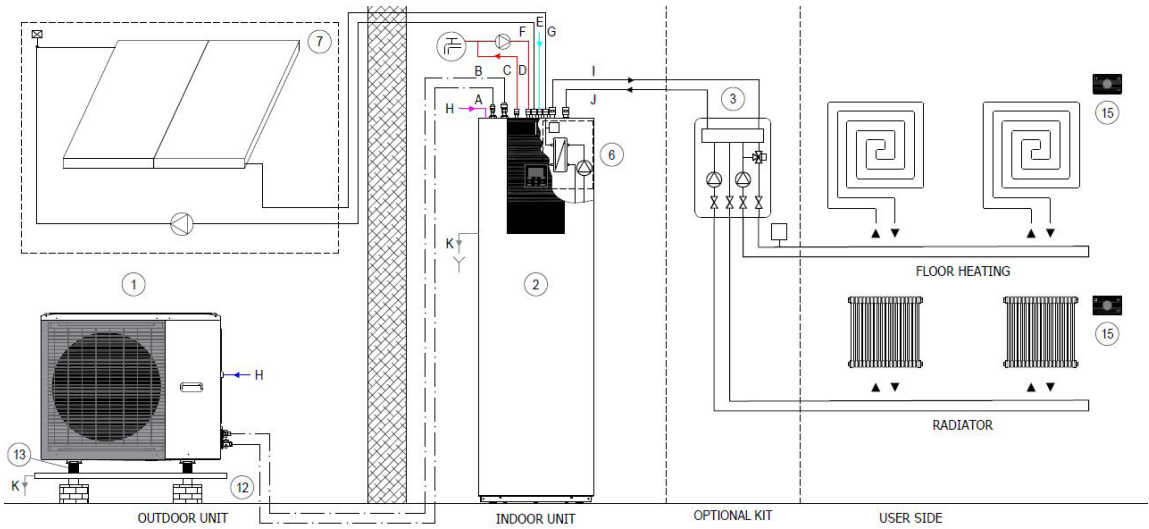

Solar kit

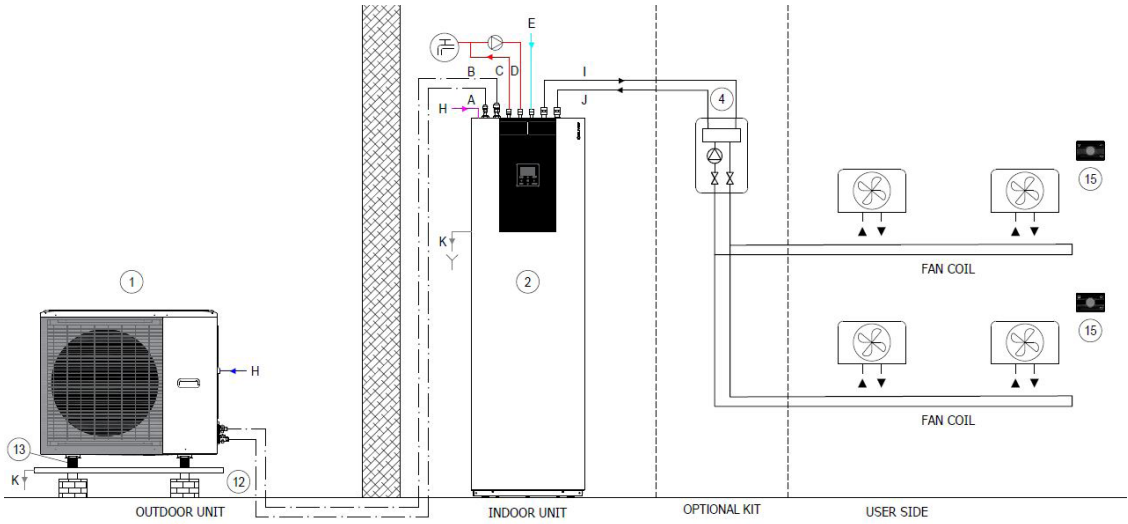

Single zone kit

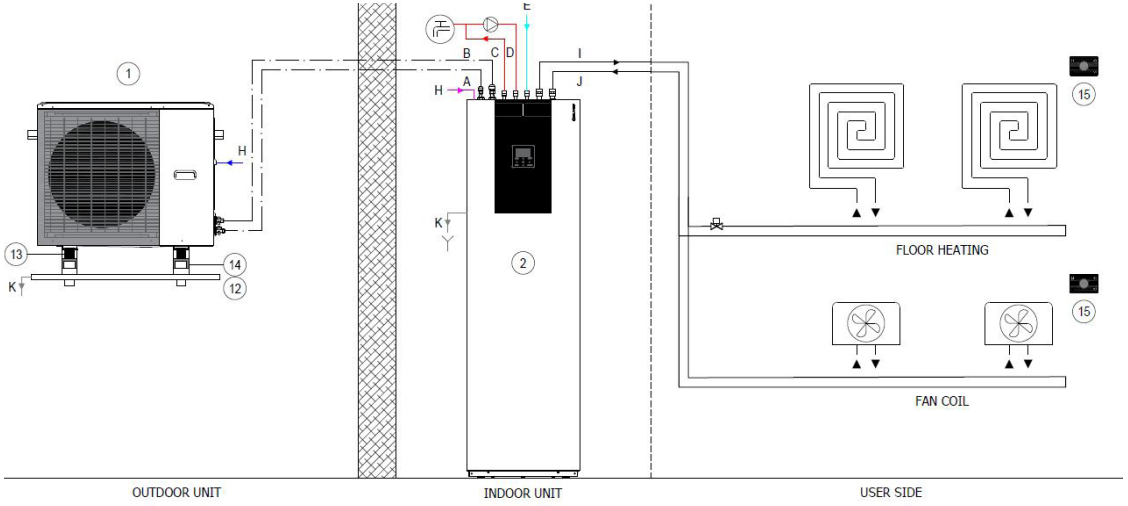

Zona Singola SV2 by the customer) Shut-off valve to exclude the radiant floors in summer mode.

System connections

General description of the system and possible connections

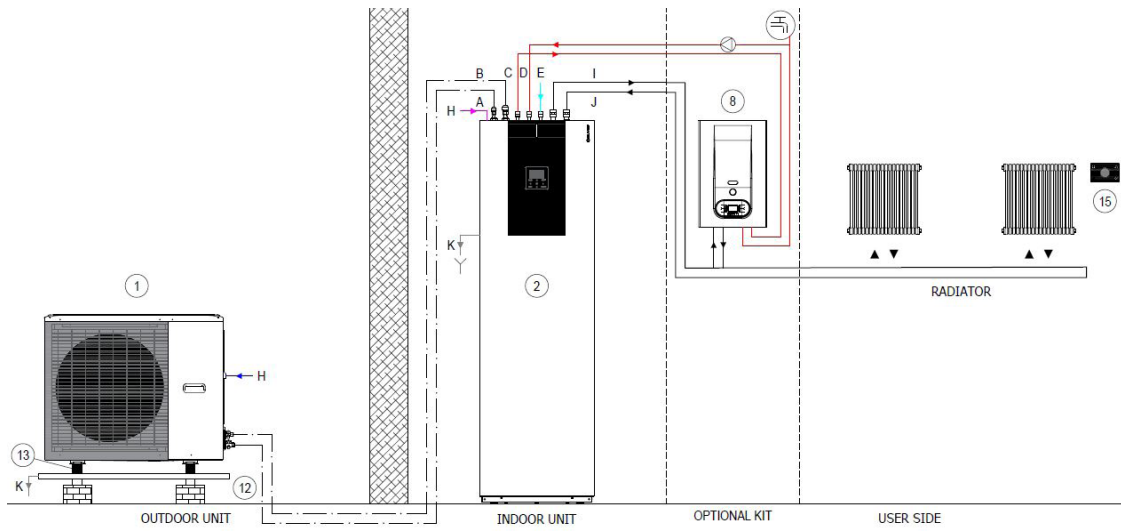

Hybrid solution

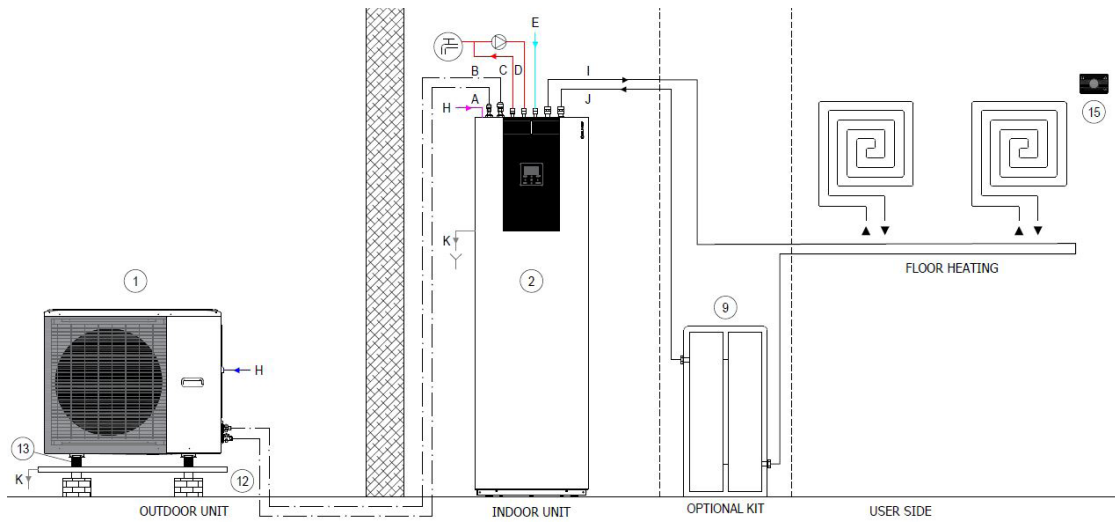

40 or 60 L inertial storage

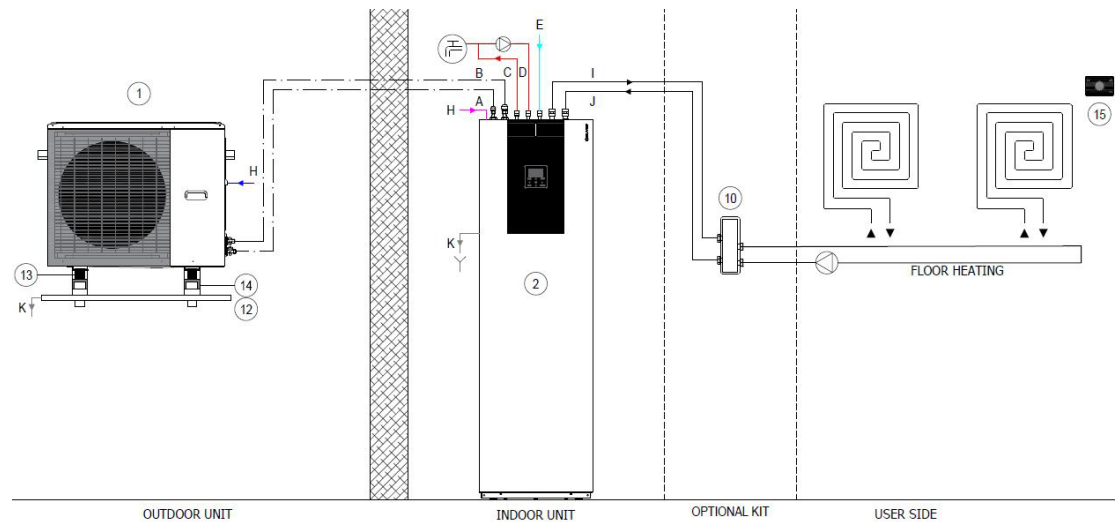

1 L circuit breaker

General description of the system and possible connections

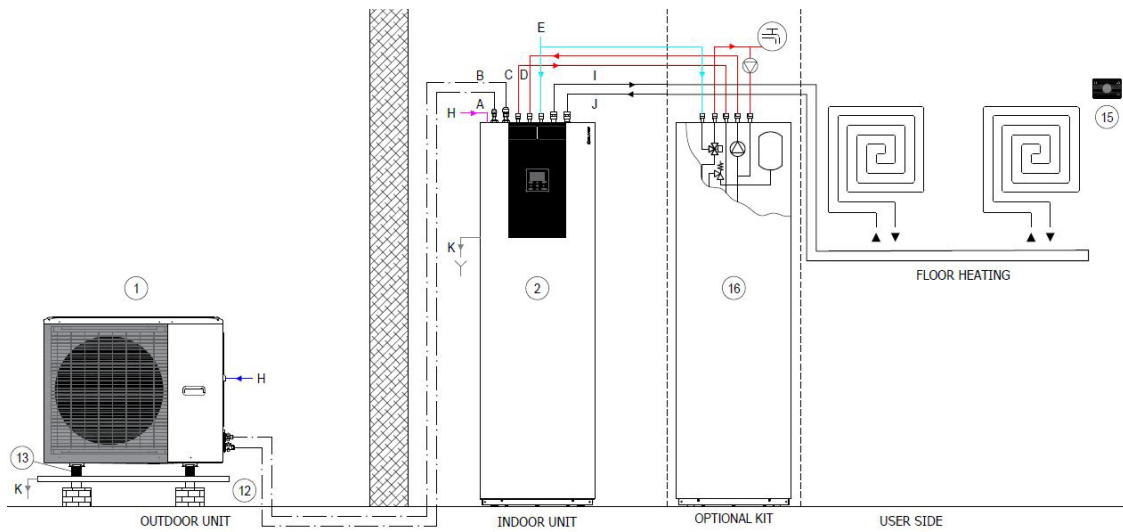

Additional 250 L storage tank

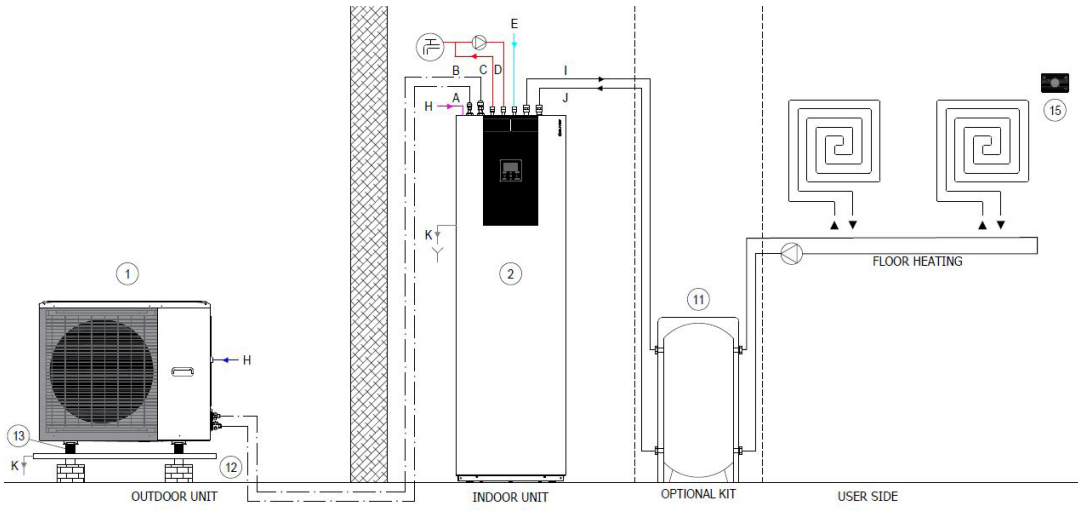

50L circuit breaker - 60L inertial storage tank

1. Outdoor unit
2. Indoor unit
3. 2 zone kit (KIRE2HX-KIRE2hXL)
4. Single zone kit (KCSX)
5. Integration electric heater (EH024 - EH3 - EH6 - EH9)
6. Integrazione solare per sanitario (SOLX) --> solo nel tower
7. Solar panel
8. Hybrid solution (HYSO24 - HYSO34)
9. 40L inertial storage tank (ACI40X)
10. 1-litre circuit breaker (DIX)
11. 50-litre circuit breaker- 60L inertial storage tank (DI50X - ACI60X)
12. Condensate drain pan (DTX)
13. Anti-vibration mount (APAVX - ASTFX)
14. Brackets wall (KSIPX)
15. Chronothermostat (HID-TCXB - HID-TCXN)
16. DHW storage (ACS200X- ACS300X - ACS500X + SCS08X - SCS12X)
17. ElfoControl³ EVO

- A. Liquid line
- B. Gas line
- C. DHW outlet
- D. Ingresso ricircolo ACS
- E. Aqueduct inlet
- F. Solar outlet
- G. Solar inlet
- H. Power input
- I. System return
- J. System supply
- K. Condensate drain

220-240V~50Hz
380-415V 3N ~50HZ con EH3 - EH6 - EH9

2.1 - 5.1 single phase 220-240V ~50Hz
6.1 - 8.1 single phase 220-240V ~50Hz
6.1 - 8.1 three-phase 380415V 3N~50Hz

- BUS RS 485
- _____ Technical water
- _____ Domestic cold water
- _____ Domestic hot water
- _____ Condensate drain

Data for the UNI/TS 11300 calculation

Clivet S.p.A. declares that the data to be used for the calculation pursuant to UNI/TS 11300 part 4 of the efficiency of their heat pump are given in the following tables.

The data given in this document may be updated without advance notice by the manufacturer when upgrading his product range..

UNI/TS 11300 Part 4

SPHERA EVO 2.0 - Size 2.1

Data for determination of COPPL T delivery 20°C		Tdesignh	A	B	C	D
2.1	Te	-10	-7	2	7	12
	PLR	100%	88%	54%	35%	15%
	DC		4,74	4,50	4,32	4,33
	CR		1,00	0,65	0,44	0,19
	P	5,39	4,74	3,05	1,99	1,45
	COP (part load)		3,15	4,96	6,81	6,23
	COP (full load)		3,15	4,46	5,42	6,37
	Fcop		1,00	1,11	1,26	0,98
Data to be provided for power and COP under full load cold source air						
2.1	Te	Tm	-7	2	7	12
	Heating capacity ΦH,HP out (kW)	35°C	4,74	4,50	4,32	4,33
		45°C	4,31	4,35	4,16	4,16
		55°C	4,40	4,40	4,08	4,50
	COP	35°C	3,15	4,46	5,42	6,37
		45°C	2,51	3,27	3,93	4,52
55°C		1,99	2,56	3,00	3,44	
DHW Power and COP data under full load			Te			
2.1	Te	Tm	7	15	20	35
	Heating capacity ΦH,HP out (kW)	55°C	4,08	5,11	5,71	6,85
	COP	55°C	3,00	3,84	4,23	3,90

SPHERA EVO 2.0 - Size 3.1

Data for determination of COPPL T delivery 20°C		Tdesignh	A	B	C	D
3.1	Te	-10	-7	2	7	12
	PLR	100%	88%	54%	35%	15%
	DC		5,51	5,89	6,18	6,28
	CR		1,00	0,57	0,35	0,15
	P	6,26	5,51	3,30	2,24	1,45
	COP (part load)		3,13	4,91	7,11	5,70
	COP (full load)		3,13	4,15	5,21	6,10
	Fcop		1,00	1,18	1,36	0,93
Data to be provided for power and COP under full load cold source air						
3.1	Te	Tm	-7	2	7	12
	Heating capacity ΦH,HP out (kW)	35°C	5,51	5,89	6,18	6,28
		45°C	5,22	6,42	6,03	6,53
		55°C	5,15	5,46	5,94	6,64
	COP	35°C	3,13	4,15	5,21	6,10
		45°C	2,41	3,07	3,83	4,41
55°C		2,03	2,56	3,07	3,55	
DHW Power and COP data under full load			Te			
3.1	Te	Tm	7	15	20	35
	Heating capacity ΦH,HP out (kW)	55°C	5,94	6,99	7,33	8,80
	COP	55°C	3,07	3,97	4,44	4,10

Data for the UNI/TS 11300 calculation

SPHERA EVO 2.0 - Size 4.1

Data for determination of COPPL T delivery 20°C		Tdesignh	A	B	C	D
4.1	Te	-10	-7	2	7	12
	PLR	100%	88%	54%	35%	15%
	DC		7,15	5,64	8,30	8,21
	CR		1,00	0,78	0,34	0,15
	P	8,13	7,15	4,65	2,91	1,85
	COP (part load)		3,30	5,17	7,08	6,01
	COP (full load)		3,30	3,69	5,31	6,41
	Fcop		1,00	1,40	1,33	0,94
Data to be provided for power and COP under full load cold source air		Te				
4.1	Te	Tm	-7	2	7	12
	Heating capacity $\Phi_{H,HP}$ out (kW)	35°C	7,15	5,64	8,30	8,21
		45°C	6,34	6,59	8,22	8,07
		55°C	6,08	6,27	7,50	7,55
	COP	35°C	3,30	3,69	5,31	6,41
		45°C	2,56	3,26	3,95	4,69
		55°C	2,17	2,69	3,19	3,72
DHW Power and COP data under full load		Te				
4.1	Te	Tm	7	15	20	35
	Heating capacity $\Phi_{H,HP}$ out (kW)	55°C	7,50	8,37	9,18	11,02
	COP	55°C	3,19	4,11	4,50	4,15

SPHERA EVO 2.0 - Size 5.1

Data for determination of COPPL T delivery 20°C		Tdesignh	A	B	C	D
5.1	Te	-10	-7	2	7	12
	PLR	100%	88%	54%	35%	15%
	DC		8,45	9,30	10,09	10,26
	CR		1,00	0,56	0,33	0,14
	P	9,60	8,45	5,23	3,47	1,96
	COP (part load)		3,18	5,03	7,33	6,16
	COP (full load)		3,18	4,12	5,01	5,97
	Fcop		1,00	1,22	1,46	1,03
Data to be provided for power and COP under full load cold source air		Te				
5.1	Te	Tm	-7	2	7	12
	Heating capacity $\Phi_{H,HP}$ out (kW)	35°C	8,45	9,30	10,09	10,26
		45°C	7,71	9,16	10,01	10,06
		55°C	7,08	8,49	9,60	9,19
	COP	35°C	3,18	4,12	5,01	5,97
		45°C	2,59	3,11	3,86	4,32
		55°C	2,11	2,66	3,10	3,65
DHW Power and COP data under full load		Te				
5.1	Te	Tm	7	15	20	35
	Heating capacity $\Phi_{H,HP}$ out (kW)	55°C	9,60	8,99	8,78	10,54
	COP	55°C	3,10	4,03	4,53	4,18

Terms and definitions

Tm = Delivery temperature

Tdesignh = A - Average design climate temperature (pursuant to UNI EN 14825)

A, B, C, D = names of the four conditions with which different outdoors air temperatures are associated (Te)

Te = Outdoors air temperature

PLR = part load ratio

DC = power under full load referred to the specified temperatures

CR = heat pump load factor

P = system power demand

COP' (full load) = COP under full load referred to the indicated outdoors air temperatures

COP' (partial load) = COP under partial load referred to the indicated outdoors air temperatures

fCOP = COP correction factor, as follows: COP' (full load) / COP (partial load)

HP = heat pump

DHW = domestic hot water

Data for the UNI/TS 11300 calculation

SPHERA EVO 2.0 - Size 6.1

Data for determination of COPPL T delivery 20°C		Tdesignh	A	B	C	D
6.1	Te	-10	-7	2	7	12
	PLR	100%	88%	54%	35%	15%
	DC		10,69	13,01	12,13	12,26
	CR		1,00	0,50	0,35	0,15
	P	12,14	10,69	6,57	4,48	3,67
	COP (part load)		3,07	4,68	6,90	6,33
	COP (full load)		3,07	3,93	5,00	5,68
	Fcop		1,00	1,19	1,38	1,12
Data to be provided for power and COP under full load cold source air		Te				
6.1	Te	Tm	-7	2	7	12
	Heating capacity ΦH,HP out (kW)	35°C	10,69	13,01	12,13	12,26
		45°C	11,21	12,52	12,30	11,56
		55°C	10,10	12,05	12,07	10,89
	COP	35°C	3,07	3,93	5,00	5,68
		45°C	3,14	3,34	3,80	4,59
		55°C	1,76	2,88	3,10	3,78
	DHW Power and COP data under full load		Te			
6.1	Te	Tm	7	15	20	35
	Heating capacity ΦH,HP out (kW)	55°C	12,07	12,30	13,71	16,45
	COP	55°C	3,10	4,19	4,59	4,23

SPHERA EVO 2.0 - Size 7.1

Data for determination of COPPL T delivery 20°C		Tdesignh	A	B	C	D
7.1	Te	-10	-7	2	7	12
	PLR	100%	88%	54%	35%	15%
	DC		12,33	12,71	14,51	12,31
	CR		1,00	0,60	0,34	0,17
	P	14,01	12,33	7,97	5,21	3,67
	COP (part load)		2,87	4,62	7,07	6,70
	COP (full load)		2,87	4,00	4,70	5,70
	Fcop		1,00	1,16	1,50	1,18
Data to be provided for power and COP under full load cold source air		Te				
7.1	Te	Tm	-7	2	7	12
	Heating capacity ΦH,HP out (kW)	35°C	12,33	12,71	14,51	12,31
		45°C	11,27	11,21	14,00	11,61
		55°C	10,35	11,71	13,85	10,94
	COP	35°C	2,87	4,00	4,70	5,70
		45°C	2,61	3,11	3,65	4,61
		55°C	2,18	2,91	3,05	3,80
	DHW Power and COP data under full load		Te			
7.1	Te	Tm	7	15	20	35
	Heating capacity ΦH,HP out (kW)	55°C	13,85	12,35	13,76	16,51
	COP	55°C	3,05	4,21	4,60	4,25

Terms and definitions

Tm = Delivery temperature

Tdesignh = A - Average design climate temperature (pursuant to UNI EN 14825)

A, B, C, D = names of the four conditions with which different outdoors air temperatures are associated (Te)

Te = Outdoors air temperature

PLR = part load ratio

DC = power under full load referred to the specified temperatures

CR = heat pump load factor

P = system power demand

COP' (full load) = COP under full load referred to the indicated outdoors air temperatures

COP' (part load) = COP under partial load referred to the indicated outdoors air temperatures

fCOP = COP correction factor, as follows: COP' (full load) / COP (part load)HP= heat pump

DHW = domestic hot water

Data for the UNI/TS 11300 calculation

SPHERA EVO 2.0 - Size 8.1

Data for determination of COPPL T delivery 20°C		Tdesignh	A	B	C	D
8.1	Te	-10	-7	2	7	12
	PLR	100%	88%	54%	35%	15%
	DC		13,82	14,30	16,01	15,20
	CR		1,00	0,59	0,34	0,16
	P	15,71	13,82	8,55	5,88	3,67
	COP (part load)		2,86	4,59	7,13	6,44
	COP (full load)		2,86	3,85	4,55	5,43
	Fcop		1,00	1,19	1,57	1,19
Data to be provided for power and COP under full load cold source air		Te				
8.1	Te	Tm	-7	2	7	12
	Heating capacity ΦH,HP out (kW)	35°C	13,82	14,30	16,01	15,20
		45°C	12,35	13,79	16,01	14,55
		55°C	11,23	13,32	16,00	13,91
	COP	35°C	2,86	3,85	4,55	5,43
		45°C	2,58	3,28	3,60	4,49
		55°C	2,13	2,80	2,90	4,00
	DHW Power and COP data under full load		Te			
8.1	Te	Tm	7	15	20	35
	Heating capacity ΦH,HP out (kW)	55°C	16,00	13,91	13,90	16,68
	COP	55°C	2,90	4,39	4,86	4,49

Terms and definitions

Tm = Delivery temperature

Tdesignh = A - Average design climate temperature (pursuant to UNI EN 14825)

A, B, C, D = names of the four conditions with which different outdoors air temperatures are associated (Te)

Te = Outdoors air temperature

PLR = part load ratio

DC = power under full load referred to the specified temperatures

CR = heat pump load factor

P = system power demand

COP' (full load) = COP under full load referred to the indicated outdoors air temperatures

COP' (partial load) = COP under partial load referred to the indicated outdoors air temperatures

fCOP = COP correction factor, as follows: COP' (full load) / COP (partial load)HP= heat pump

DHW = domestic hot water

Data for the UNI/TS 11300 calculation

The specified data refer to the nominal power values under the declared conditions

UNI/TS 11300 Part 3

SIZE	Cooling capacity kW				EER				
	Test	1	2	3	4	1	2	3	4
		100%	75%	50%	25%	100%	75%	50%	25%
220-240V N 50Hz									
2.1		4,26	3,20	2,05	0,90	3,50	4,71	5,84	5,81
3.1		6,25	4,59	2,96	1,35	3,09	4,43	6,17	7,40
4.1		7,46	5,20	3,51	1,63	3,33	4,48	6,67	9,30
5.1		9,10	6,43	4,25	1,94	3,09	4,26	6,73	10,48
6.1		11,80	8,89	6,01	2,91	2,75	3,89	5,73	7,88
7.1		12,86	9,40	6,29	2,91	2,55	3,78	5,71	7,88
8.1		14,20	10,53	7,12	2,91	2,45	3,54	5,38	7,88

Reference conditions prescribed by UNI/TS 11300-3:

1. External air temperature B.S. 35°C Refrigerated water temperature at the fancoil inlet/outlet 12/7 °C
2. External air temperature B.S. 30°C Refrigerated water temperature at the fancoil outlet /7 °C
3. External air temperature B.S. 25°C Refrigerated water temperature at the fancoil outlet /7 °C
4. External air temperature B.S. 20°C Refrigerated water temperature at the fancoil outlet /7 °C

Compared to traditional systems, SPHERA EVO 2.0 provides numerous advantages from an economic point of view and in terms of energy. Below is a real case in a domestic system before and after replacing a gas boiler with a SPHERA EVO 2.0 solution.

Natural gas

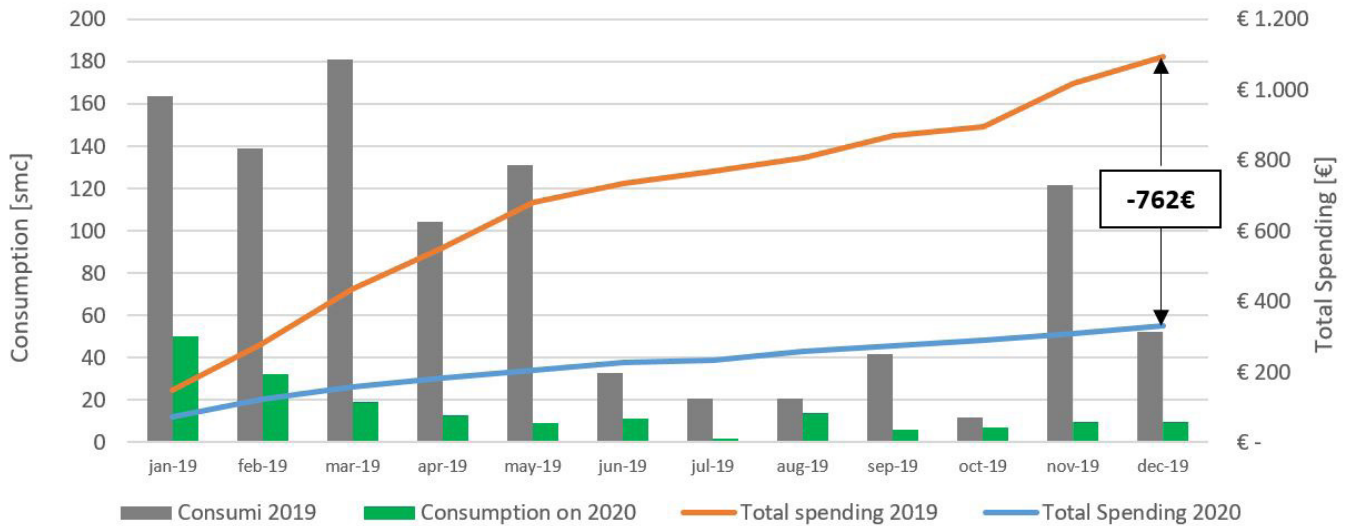

Electricity

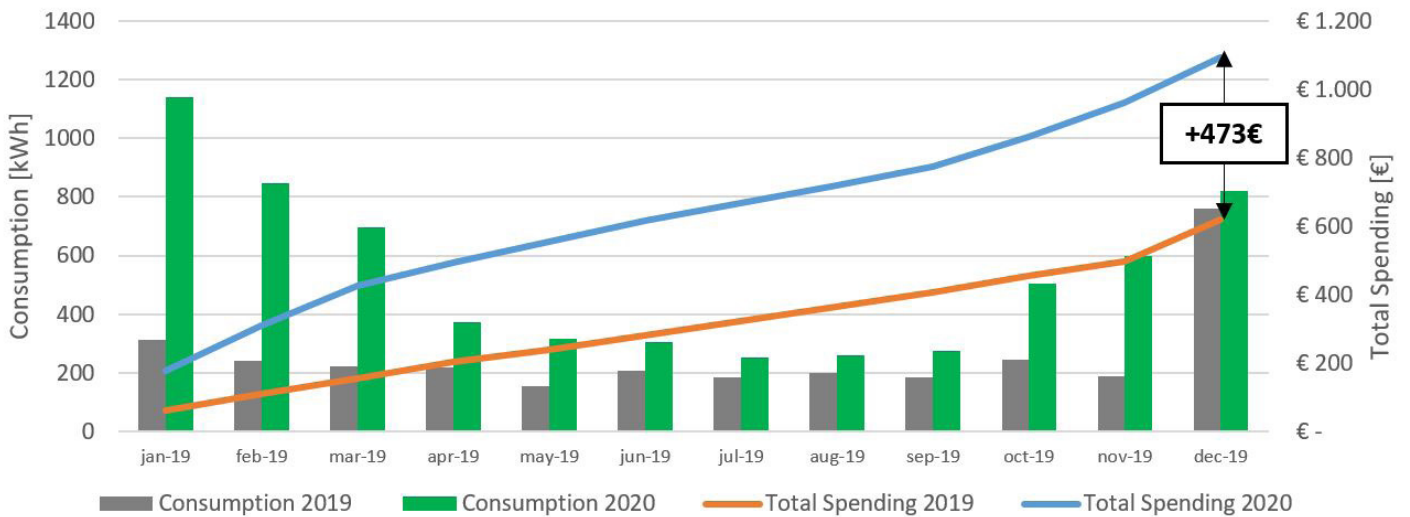

The graphs show the consumption and cost of natural gas and electricity for 2019 and 2020 (heat pump installed at the end of December 2019).

Year	Natural gas cost	Electricity cost	Total cost	Savings
2019	1092 €	620 €	1712 €	289 € -20%
2020	330 €	1093 €	1423 €	

The savings were obtained without changing any aspect of the previous system except for the heat generator. The heating terminals are radiators with an operating temperature of 55°C. The use of low temperature terminals (underfloor heating) would allow for double the amount of savings.

EuroSwitch Function

SPHERA EVO 2.0 provides a useful instrument for maximising savings, for hybrid systems with a gas boiler, through the EuroSwitch function. Based on the set price of natural gas and electricity, the heat pump will assign priority to its own operation rather than that of the boiler depending on its efficiency. The aim is to always use the most cost-effective heat source.

Case 1 - Typical day in January - Radiators (supply temperature = 55°C)

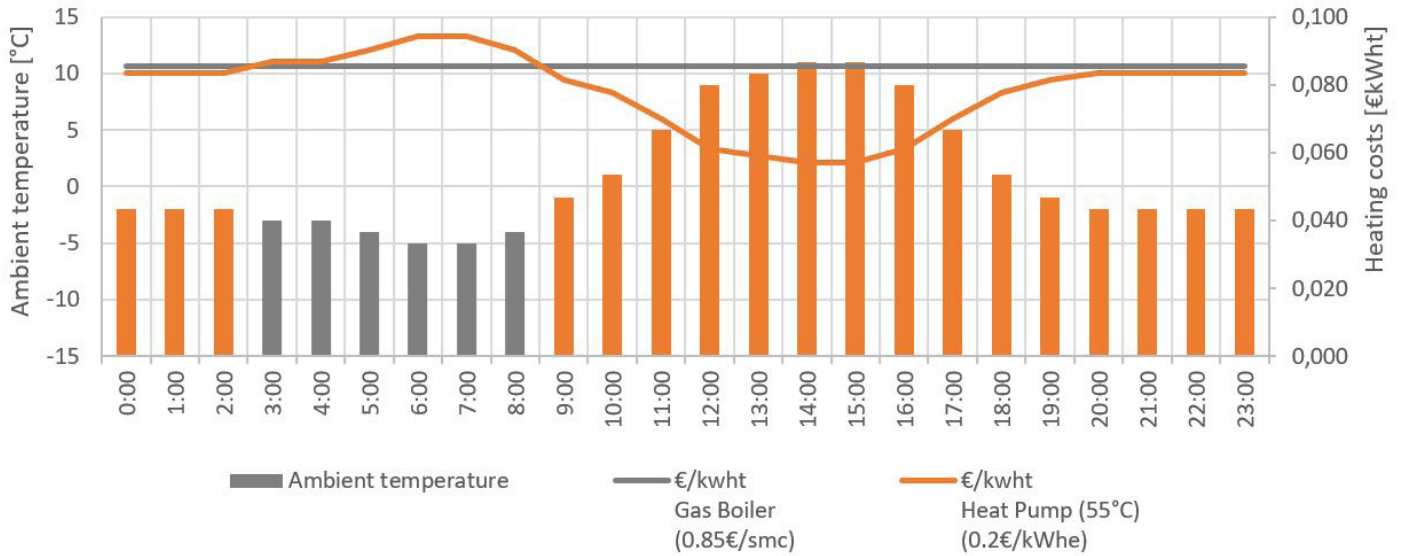

From 03:00am to 08:00am, heat will be produced by the boiler, while during other time slots, it will be produced by the heat pump.

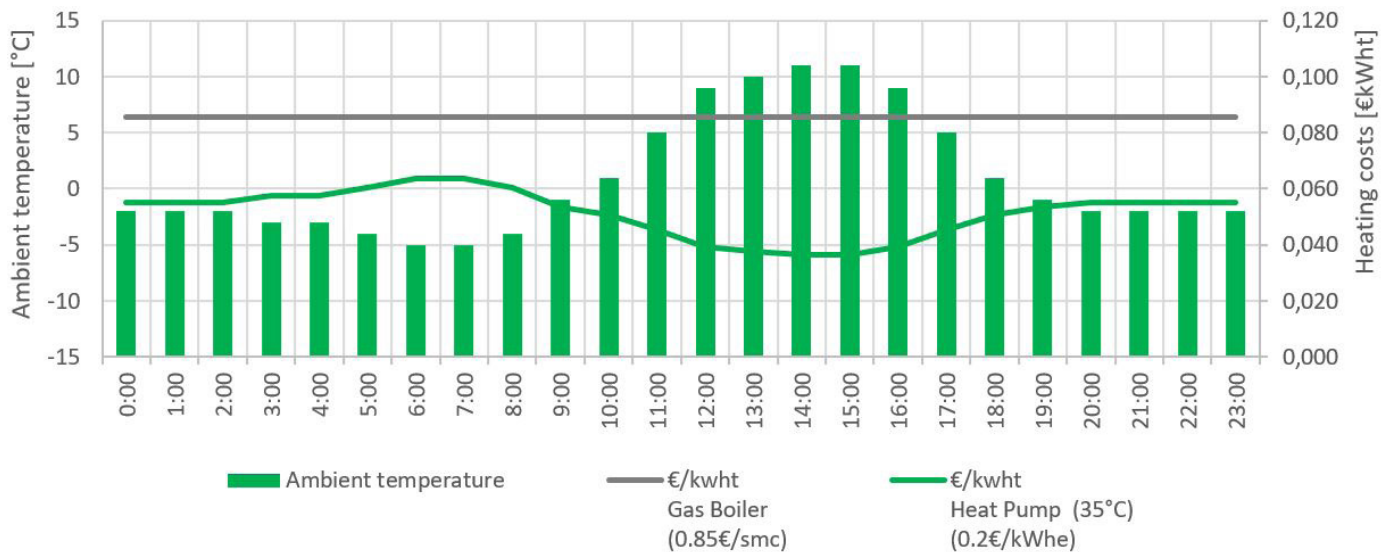

Case 2 - Typical day in January - Radiant floor (supply temperature = 35°C)

Heat will be produced by the heat pump during the whole day.

The graphs show the trend of the daily temperature and of the cost for thermal energy. The heat pump's efficiency varies according to the outdoor temperature and the water temperature, while the boiler has a fixed efficiency. The calculations consider an average cost of natural gas equal to 0.85 €/SCM and of electricity equal to 0.2 €/SCM.

SPHERA EVO 2.0 - SQKN-YEE 1 TC A TOWER 190 L

DAAGL0001 REV00
DATA/DATE 07/06/2021

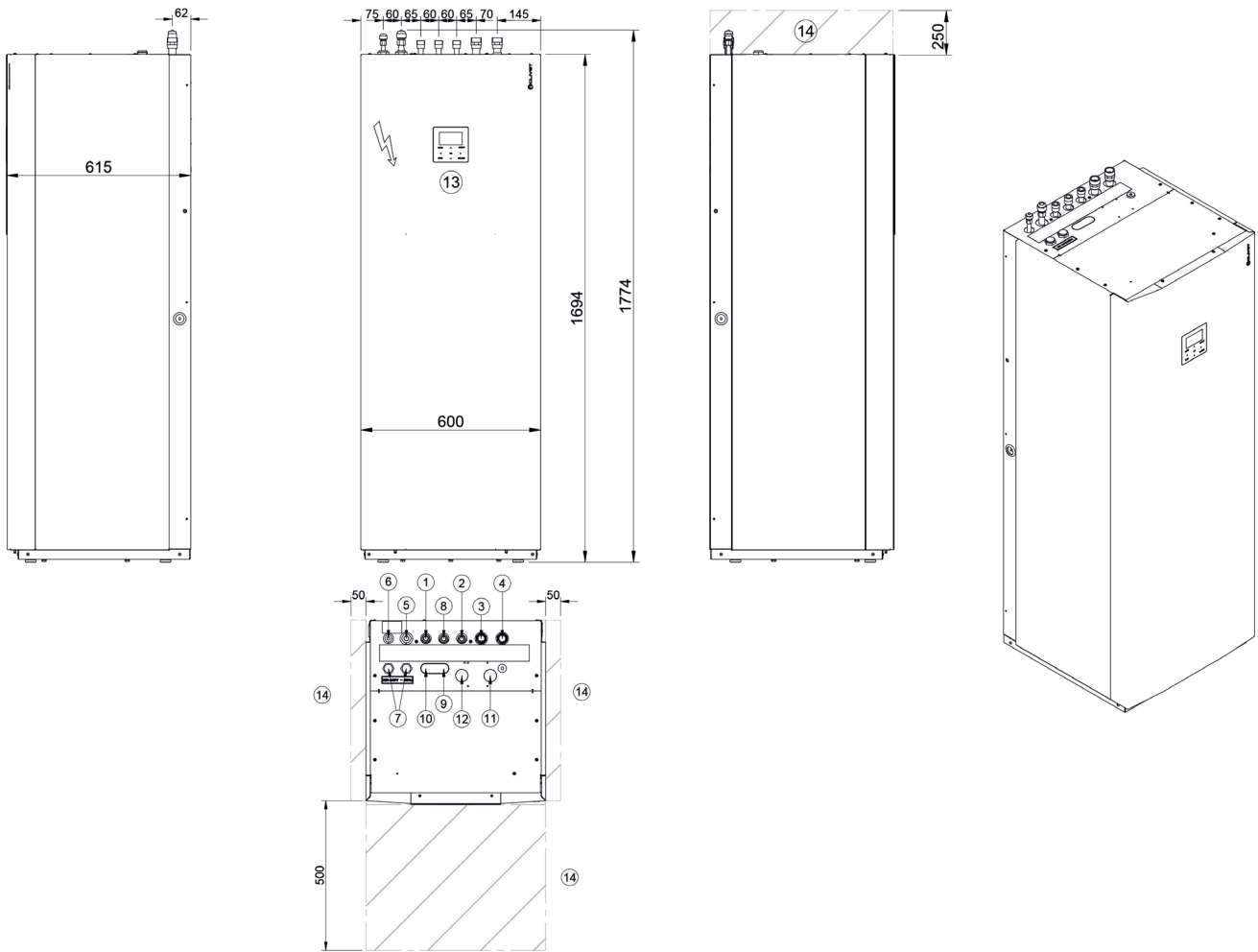

1. Domestic hot water outlet M 3/4"
2. Mains inlet M 3/4"
3. Return for the utility installation M 1"
4. Supply to the utility installation M 1"
5. Return connection 5/8" SAE (*)
6. Liquid connection 3/8" SAE (*)
7. Electrical line inlet
8. DHW recirculation circuit M 3/4"
9. Solar system outlet M 3/4" (optional accessory)
10. Solar system inlet M 3/4" (optional accessory)
11. Gas boiler outlet M 1" (optional accessory)
12. Gas boiler inlet M 1" (optional accessory)
13. Control keypad
14. Functional spaces for standard unit

(*) see instructions in kit RGGL00009

SIZE	190 L	
Operation weight	kg	359
Shipping weight	kg	187

The presence of optional accessories may result in a substantial variation of the weights shown in the table.

Dimensional drawings

SPHERA EVO 2.0 - SQNK-YEE 1 TC A-B TOWER 250 L

DAAGL0002 REV00
DATA/DATE 07/06/2021

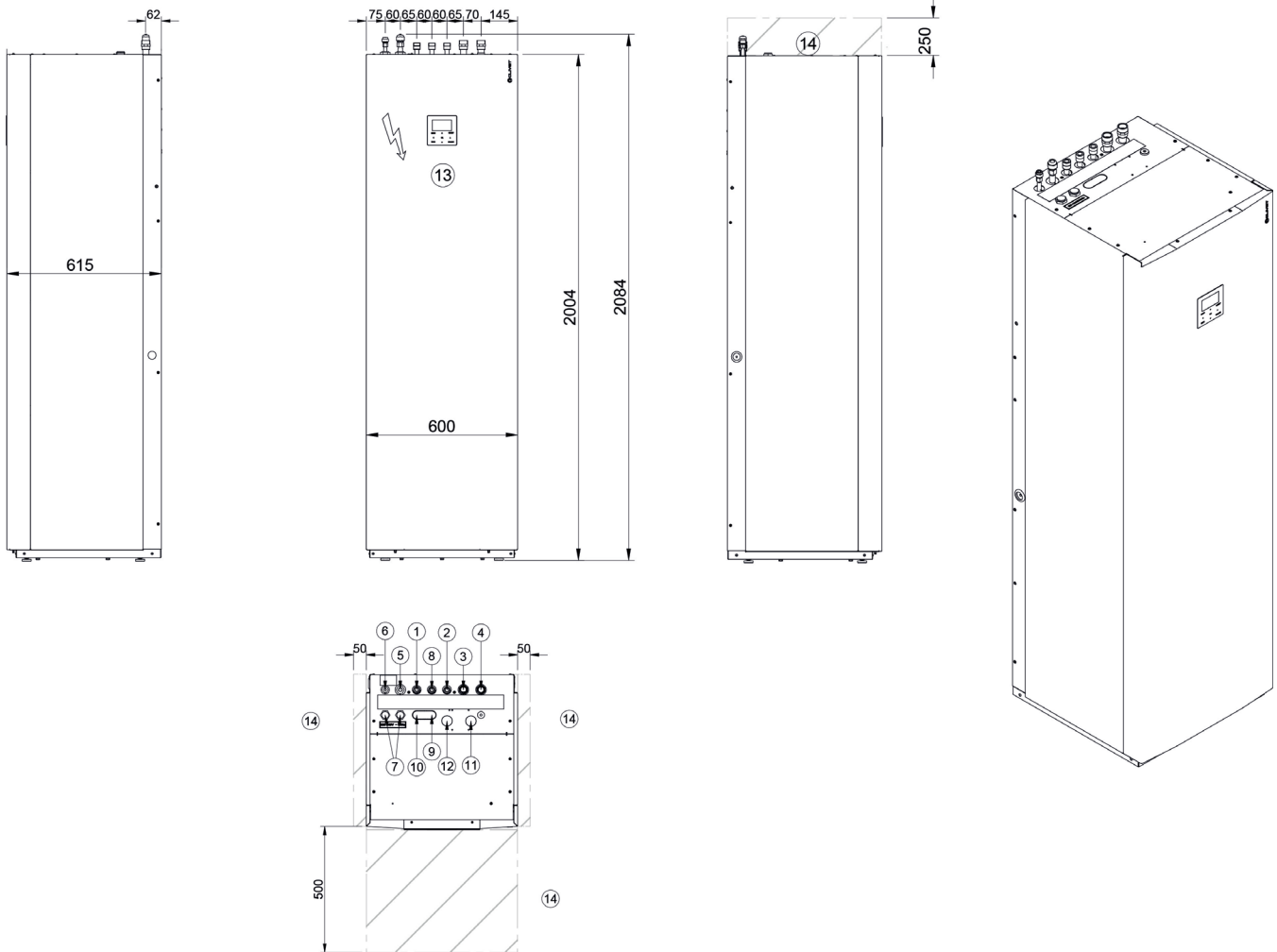

1. Domestic hot water outlet M 3/4"
2. Mains inlet M 3/4"
3. Return for the utility installation M 1"
4. Supply to the utility installation M 1"
5. Return connection 5/8" SAE (*)
6. Liquid connection 3/8" SAE (*)
7. Electrical line inlet
8. DHW recirculation circuit M 3/4"
9. Solar system outlet M 3/4" (optional accessory)
10. Solar system inlet M 3/4" (optional accessory)
11. Gas boiler outlet M 1" (optional accessory)
12. Gas boiler inlet M 1" (optional accessory)
13. Control keypad
14. Functional spaces for standard unit

(*) see instructions in kit RGGL00001

RANGE		GABC	GBBC
SIZE		250 L	250 L
Operation weight	kg	419	421
Shipping weight	kg	192	194

The presence of optional accessories may result in a substantial variation of the weights shown in the table.

SPHERA EVO 2.0 (outdoor unit) - 2.1 - 3.1

DAAQ80002_REV00
DATA/DATE 29/04/2021

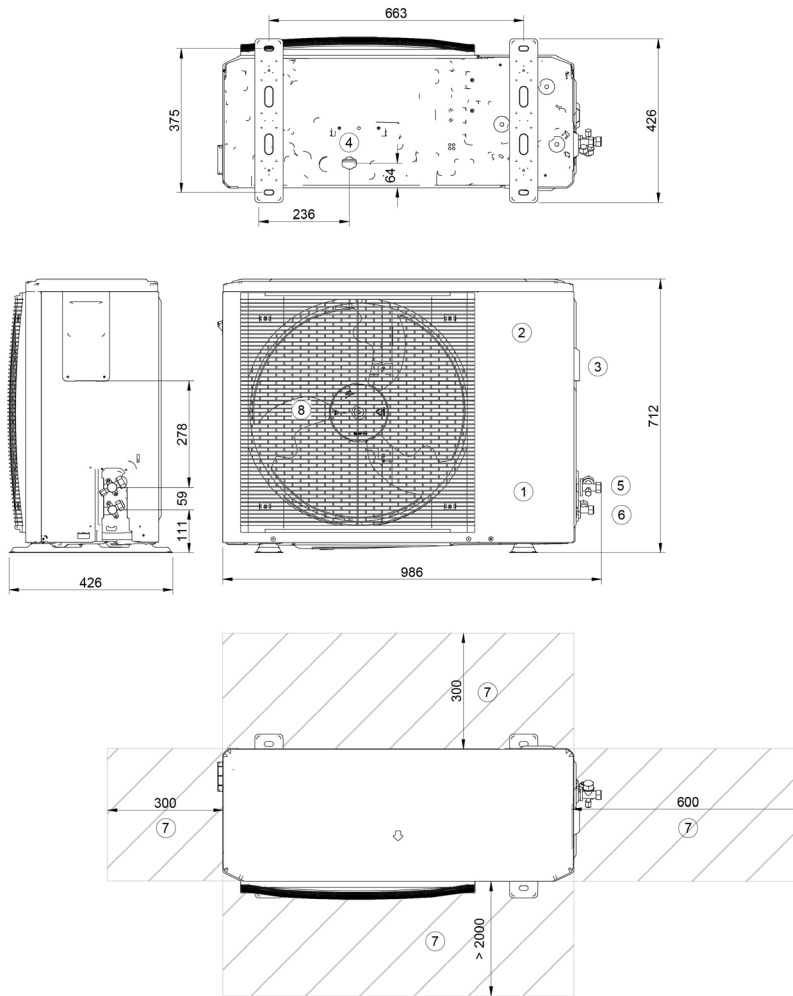

1. Compressor enclosure
2. Electrical panel
3. Power input
4. Condensate drain
5. Gas connections (1/4")
6. Gas connections (5/8")
7. Functional spaces
8. Electrical fan

SIZE		2.1	3.1
Operation weight	kg	58	58
Shipping weight	kg	64	64

The presence of optional accessories may result in a substantial variation of the weights shown in the table.

Dimensional drawings

SPHERA EVO 2.0 (outdoor unit) - 4.1 - 8.1

DAAQ80001_REV01
DATA/DATE 29/01/2021

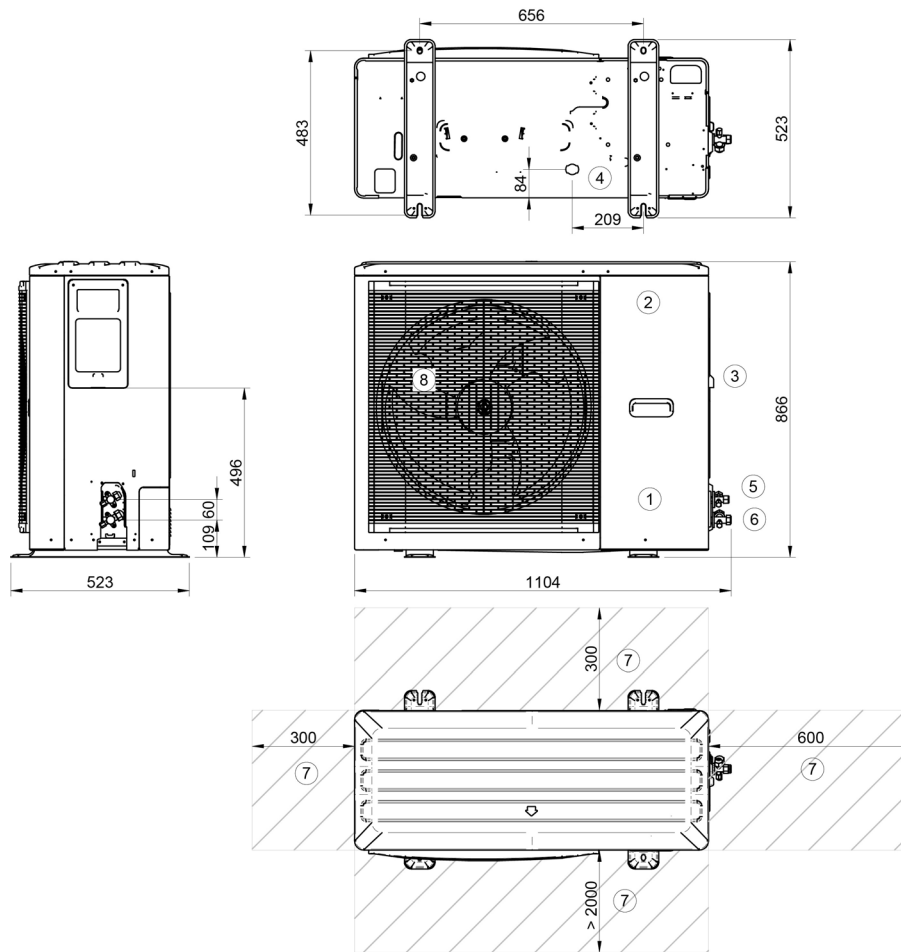

1. Compressor enclosure
2. Electrical panel
3. Power input
4. Condensate drain
5. Gas connections (3/8")
6. Gas connections (5/8")
7. Functional spaces
8. Electrical fan

SIZE		4.1 / 1Ph	5.1 / 1Ph	6.1 / 1Ph	6.1 / 3Ph	7.1 / 1Ph	7.1 / 3Ph	8.1 / 1Ph	8.1 / 3Ph
Operation weight	kg	77	77	96	112	96	112	96	112
Shipping weight	kg	88	88	110	125	110	125	110	125

The presence of optional accessories may result in a substantial variation of the weights shown in the table.

Page intentionally left blank

Page intentionally left blank

FOR OVER 30 YEARS WE HAVE BEEN
OFFERING SOLUTIONS TO ENSURE
SUSTAINABLE COMFORT AND THE WELL-
BEING OF PEOPLE AND THE ENVIRONMENT

www.clivet.com

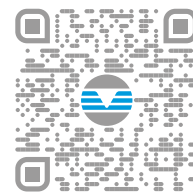

sale and assistance

SPHERA EVO 2.0 Tower - BT21F058GB-01



CLIVET SPA

Via Camp Lonc 25, Z.I. Villapaiera
32032 Feltre (BL) - Italy
Tel. +39 0439 3131 - Fax +39 0439 313300
info@clivet.it

MideaGroup
humanizing technology