



DATA BOOK

HYPER INVERTER PACKAGED AIR-CONDITIONERS (Split system, air to air heat pump type)

CEILING CASSETTE-4 WAY TYPE

Single type

FDT71VNXWVH

Twin type

FDT71VNXWPVH

DUCT CONNECTED-HIGH STATIC PRESSURE TYPE

Single type

FDU71VNXWVH

CEILING SUSPENDED TYPE

Single type

FDE71VNXWVH

Twin type

FDE71VNXWPVH

V Multi System

(OUTDOOR UNIT) (INDOOR UNIT)

FDC71VNX-W FDT40VH FDE40VH

CEILING CASSETTE-4 WAY COMPACT TYPE

Twin type

FDTC71VNXWPVH

DUCT CONNECTED-LOW/MIDDLE STATIC PRESSURE TYPE

Single type

FDUM71VNXWVH

Twin type

FDUM71VNXWPVH

WALL MOUNTED TYPE

Single type

SRK71VNXWZR

TABLE OF CONTENTS

1. HYPER INVERTER PACKAGED AIR-CONDITIONERS	2
2. V MULTI SYSTEM	130
3. OPTION PARTS	140

1. HYPER INVERTER PACKAGED AIR-CONDITIONERS

CONTENTS

1.1 SPECIFICATIONS	4
(1) Ceiling cassette-4 way type (FDT)	4
(2) Ceiling cassette-4 way compact type (FDTC)	6
(3) Duct connected-High static pressure type (FDU)	7
(4) Duct connected-Low/Middle static pressure type (FDUM)	8
(5) Ceiling suspended type (FDE)	10
(6) Wall mounted type (SRK)	12
1.2 EXTERIOR DIMENSIONS	13
(1) Indoor units	13
(2) Outdoor unit	21
(3) Remote control (Option parts)	22
1.3 ELECTRICAL WIRING	25
(1) Indoor units	25
(2) Outdoor unit	32
1.4 NOISE LEVEL	33
1.5 CHARACTERISTICS OF FAN	37
1.6 TEMPERATURE AND VELOCITY DISTRIBUTION	39
1.7 PIPING SYSTEM	44
1.8 RANGE OF USAGE & LIMITATIONS	46
1.9 SELECTION CHART	49
1.9.1 Capacity tables	49
(1) Ceiling cassette-4 way type (FDT)	49
(2) Ceiling cassette-4 way compact type (FDTC)	50
(3) Duct connected-High static pressure type (FDU)	50
(4) Duct connected-Low/Middle static pressure type (FDUM)	51
(5) Ceiling suspended type (FDE)	52
(6) Wall mounted type (SRK)	53
1.9.2 Correction of cooling and heating capacity in relation to air flow rate control (Fan speed)	55
1.9.3 Correction of cooling and heating capacity in relation to one way length of refrigerant piping	55
1.9.4 Height difference between the indoor unit and outdoor unit	55
1.10 APPLICATION DATA	56
1.10.1 Installation of indoor unit	56
(1) Ceiling cassette-4 way type (FDT)	56
(2) Ceiling cassette-4 way compact type (FDTC)	62
(3) Duct connected-High static pressure type (FDU)	70
(4) Duct connected-Low/Middle static pressure type (FDUM)	76
(5) Ceiling suspended type (FDE)	82

(6) Wall mounted type (SRK) 86

(7) Effective range of cool/hot wind (Reference) 90

1.10.2 Electric wiring work installation 91

1.10.3 Installation of wired remote control (Option parts) 95

1.10.4 Installation of outdoor unit107

1.10.5 Instructions for branching pipe set (DIS-WA1,WB1,TA1,TB1)115

1.10.6 Safety precautions in handling air-conditioners with flammable refrigerants118

1.11 TECHNICAL INFORMATION121

(1) Ceiling cassette-4 way type (FDT)121

(2) Ceiling cassette-4 way compact type (FDTC)123

(3) Duct connected-High static pressure type (FDU)124

(4) Duct connected-Low/Middle static pressure type (FDUM)125

(5) Ceiling suspended type (FDE)127

(6) Wall mounted type (SRK)129

■ How to read the model name

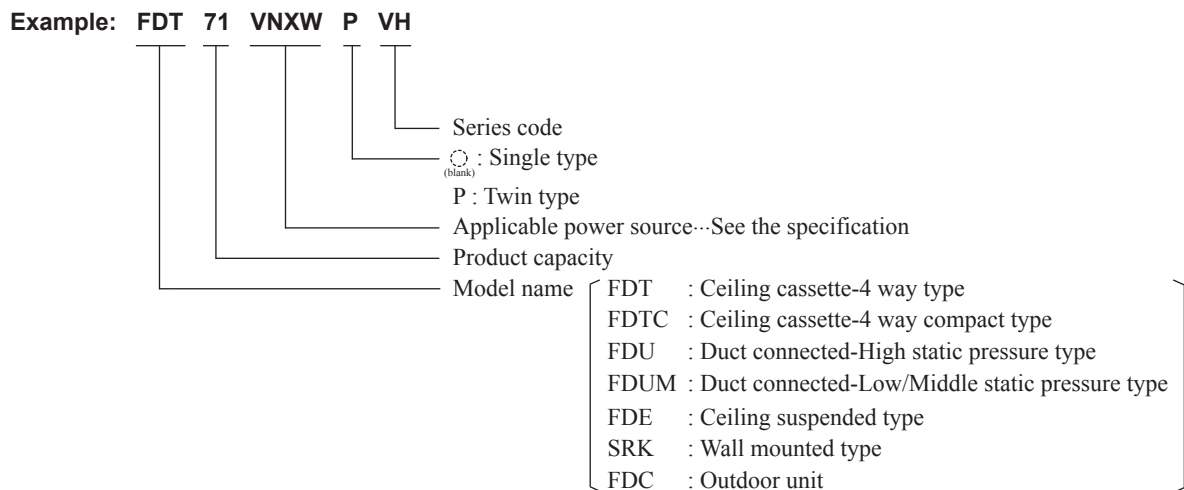

1.1 SPECIFICATIONS

(1) Ceiling cassette-4 way type (FDT)

Single type

Item		Model	FDT71VNXWVH		
			Indoor unit FDT71VH	Outdoor unit FDC71VNX-W	
Power source			1 Phase, 220-240V 50Hz / 220V 60Hz		
Operation data	Nominal cooling capacity (range)	kW	7.1 [3.2(Min.) - 8.0(Max.)]		
	Nominal heating capacity (range)	kW	8.0 [3.6(Min.) - 9.0(Max.)]		
	Power consumption	Cooling	kW	1.69	
		Heating		1.75	
	Max power consumption		4.11		
	Running current	Cooling	A	7.5 / 7.8	
		Heating		7.8 / 8.2	
	Inrush current, max current		5, 19.1		
	Power factor	Cooling	%	98	
		Heating		97	
	EER	Cooling		4.20	
	COP	Heating		4.58	
	Sound power level	Cooling	dB(A)	64	66
		Heating			
Sound pressure level	Cooling	dB(A)	P-Hi: 46 Hi: 35 Me: 33 Lo: 31		
	Heating			51	
Silent mode sound pressure level	Cooling	dB(A)	—		
	Heating		49 / 47(Normal/Silent)		
			46.5 / 45.5(Normal/Silent)		
Exterior dimensions (Height x Width x Depth)		mm	Unit 236 × 840 × 840 Panel 35 × 950 × 950	750 × 880(+88) × 340	
Exterior appearance (Munsell color) (RAL color)			Plaster white (6.8Y8.9/0.2) near equivalent (RAL 9003) near equivalent	Stucco white (4.2Y7.5/1.1) near equivalent (RAL 7044) near equivalent	
Net weight		kg	Unit 21 Panel 5	60	
Compressor type & Q'ty			—	RMT5118SWP1 x 1	
Compressor motor (Starting method)		kW	—	Direct line start	
Refrigerant oil (Amount, type)		L	—	0.675 (DIAMOND FREEZE MB75)	
Refrigerant (Type, amount, pre-charge length)		kg	R32 2.75 in outdoor unit (Incl. the amount for the piping of 30m)		
Heat exchanger			Louver fin & inner grooved tubing	M shape fin & inner grooved tubing	
Refrigerant control			Electronic expansion valve		
Fan type & Q'ty			Turbo fan x1	Propeller fan x1	
Fan motor (Starting method)		W	50 < Direct line start >	86 < Direct line start >	
Air flow	Cooling	m³/min	P-Hi: 28 Hi: 21 Me: 19 Lo: 17		
	Heating		60		
Available external static pressure		Pa	0		
Outside air intake			Possible		
Air filter, Quality / Quantity			Pocket plastic net x1(Washable)		
Shock & vibration absorber			Rubber sleeve (for fan motor)	Rubber sleeve (for fan motor & compressor)	
Electric heater		W	—	20(Crank case heater)	
Operation control	Remote control		(Option) Wired : RC-EX3A , RC-E5 , RCH-E3 Wireless : RCN-T-5AW-E2		
	Room temperature control		Thermostat by electronics		
	Operation display		—		
Safety equipments			Compressor overheat protection, Overcurrent protection Frost protection, Serial signal error protection, Indoor fan motor error protection Heating overload protection(High pressure control), Cooling overload protection		
Installation data	Refrigerant piping size (O.D)	Liquid line	I/U φ 9.52 (3/8") Pipe φ 9.52 (3/8")x0.8 O/U φ 9.52 (3/8")		
		Gas line	φ 15.88 (5/8") φ 15.88(5/8")x1.0 φ 15.88 (5/8")		
	Connecting method		Flare piping	Flare piping	
	Attached length of piping	m	—		
	Insulation for piping		Necessary (both Liquid & Gas lines)		
	Refrigerant line (one way) length	m	Max.50m		
Vertical height diff. between O/U and I/U	m	Max.30m (Outdoor unit is higher)	Max.15m (Outdoor unit is lower)		
Drain hose		Hose connectable VP25 (O.D.32)	Hole size φ 20 x 4 pcs		
Drain pump, max lift height		mm	—		
Recommended breaker size		A	—		
L.R.A. (Locked rotor ampere)		A	5.0		
Interconnecting wires		Size x Core number	φ 1.6mm x 3 cores (Including earth cable) / Terminal block (Screw fixing type)		
IP number			IPX0	IP24	
Standard accessories			Mounting kit, Drain hose		
Option parts			Motion sensor :LB-T-5W-E		

Notes (1) The data are measured at the following conditions.

The pipe length is 7.5m.

Operation	Item	Indoor air temperature		Outdoor air temperature		Standards
		DB	WB	DB	WB	
Cooling		27°C	19°C	35°C	24°C	ISO5151-T1
Heating		20°C	—	7°C	6°C	ISO5151-H1

(2) This air-conditioner is manufactured and tested in conformity with the ISO.

(3) Sound level indicates the value in an anechoic chamber. During operation these values are somewhat higher due to ambient conditions.

(4) Select the breaker size according to the own national standard.

(5) The operation data indicate when the air-conditioner is operated at 230V 50Hz or 220V 60Hz.

Twin type

Item		Model	FDT71VNXWPH		
			Indoor unit FDT40VH (2 units)	Outdoor unit FDC71VNX-W	
Power source			1 Phase, 220-240V 50Hz / 220V 60Hz		
Operation data	Nominal cooling capacity (range)	kW	7.1 [3.2(Min.) - 8.0(Max.)]		
	Nominal heating capacity (range)	kW	8.0 [3.6(Min.) - 9.0(Max.)]		
	Power consumption	Cooling	kW	1.61	
		Heating		1.83	
	Max power consumption		4.11		
	Running current	Cooling	A	7.2 / 7.5	
		Heating		8.1 / 8.5	
	Inrush current, max current		5, 19.1		
	Power factor	Cooling	%	98	
		Heating		98	
	EER	Cooling		4.40	
	COP	Heating		4.38	
	Sound power level	Cooling	dB(A)	55	66
		Heating			
Sound pressure level	Cooling	dB(A)	P-Hi: 39 Hi: 33 Me: 31 Lo: 30		
	Heating		51		
Silent mode sound pressure level	Cooling	dB(A)	—		
	Heating		49 / 47(Normal/Silent)		
			46.5 / 45.5(Normal/Silent)		
Exterior dimensions (Height x Width x Depth)		mm	Unit 236 × 840 × 840 Panel 35 × 950 × 950	750 × 880(+88) × 340	
Exterior appearance (Munsell color) (RAL color)			Plaster white (6.8Y8.9/0.2) near equivalent (RAL 9003) near equivalent	Stucco white (4.2Y7.5/1.1) near equivalent (RAL 7044) near equivalent	
Net weight		kg	Unit 19 Panel 5	60	
Compressor type & Q'ty			—	RMT5118SWP1 x 1	
Compressor motor (Starting method)		kW	—	Direct line start	
Refrigerant oil (Amount, type)		L	—	0.675 (DIAMOND FREEZE MB75)	
Refrigerant (Type, amount, pre-charge length)		kg	R32 2.75 in outdoor unit (Incl. the amount for the piping of 30m)		
Heat exchanger			Louver fin & inner grooved tubing	M shape fin & inner grooved tubing	
Refrigerant control			Electronic expansion valve		
Fan type & Q'ty			Turbo fan x1	Propeller fan x1	
Fan motor (Starting method)		W	50 < Direct line start >	86 < Direct line start >	
Air flow	Cooling	m³/min	P-Hi: 20 Hi: 18 Me: 16 Lo: 14		
	Heating		60		
Available external static pressure		Pa	0		
Outside air intake			Possible		
Air filter, Quality / Quantity			Pocket plastic net x1(Washable)		
Shock & vibration absorber			Rubber sleeve (for fan motor)	Rubber sleeve (for fan motor & compressor)	
Electric heater		W	—	20(Crank case heater)	
Operation control	Remote control		(Option) Wired : RC-EX3A , RC-E5 , RCH-E3 Wireless : RCN-T-5AW-E2		
	Room temperature control		Thermostat by electronics		
	Operation display		—		
Safety equipments			Compressor overheat protection, Overcurrent protection Frost protection, Serial signal error protection, Indoor fan motor error protection Heating overload protection(High pressure control), Cooling overload protection		
Installation data	Refrigerant piping size (O.D)	Liquid line	I/U φ 6.35 (1/4") ② φ 9.52(3/8")x0.8 ① φ 9.52(3/8")x0.8 O/U φ 9.52 (3/8")		
		Gas line	I/U φ 12.7 (1/2") ② φ 12.7(1/2")x0.8 ① φ 15.88(5/8")x1.0 O/U φ 15.88 (5/8")		
	Connecting method		Flare piping	Flare piping	
	Attached length of piping	m	—		
	Insulation for piping		Necessary (both Liquid & Gas lines)		
	Refrigerant line (one way) length	m	Max.50m		
Vertical height diff. between O/U and I/U	m	Max.30m (Outdoor unit is higher)	Max.15m (Outdoor unit is lower)		
Drain hose		Hose connectable VP25 (O.D.32)	Hole size φ 20 x 4 pcs		
Drain pump, max lift height		mm	Built-in drain pump , 850		
Recommended breaker size		A	—		
L.R.A. (Locked rotor ampere)		A	5.0		
Interconnecting wires		Size x Core number	φ 1.6mm x 3 cores (Including earth cable) / Terminal block (Screw fixing type)		
IP number			IPX0	IP24	
Standard accessories			Mounting kit, Drain hose		
Option parts			Motion sensor :LB-T-5W-E		

Notes (1) The data are measured at the following conditions.

The pipe length is 7.5m.

Operation	Item	Indoor air temperature		Outdoor air temperature		Standards
		DB	WB	DB	WB	
Cooling		27°C	19°C	35°C	24°C	ISO5151-T1
Heating		20°C	—	7°C	6°C	ISO5151-H1

(2) This air-conditioner is manufactured and tested in conformity with the ISO.

(3) Sound level indicates the value in an anechoic chamber. During operation these values are somewhat higher due to ambient conditions.

(4) Select the breaker size according to the own national standard.

(5) The operation data indicate when the air-conditioner is operated at 230V 50Hz or 220V 60Hz.

(2) Ceiling cassette-4 way compact type (FDTC)
Twin type

Item			Model	FDTC71VNXWVPH	
				Indoor unit FDTC40VH (2 units)	Outdoor unit FD71VNX-W
Power source				1 Phase, 220-240V 50Hz / 220V 60Hz	
Operation data	Nominal cooling capacity (range)		kW	7.1 [3.2(Min.) - 8.0(Max.)]	
	Nominal heating capacity (range)		kW	8.0 [3.6(Min.) - 9.0(Max.)]	
	Power consumption	Cooling	kW	1.73	
		Heating		1.83	
	Max power consumption			4.11	
	Running current	Cooling	A	7.7 / 8.0	
		Heating		8.1 / 8.5	
	Inrush current, max current			5, 19.1	
	Power factor	Cooling	%	98	
		Heating		98	
	EER	Cooling		4.12	
	COP	Heating		4.37	
	Sound power level	Cooling	dB(A)	59	
Heating		66			
Sound pressure level	Cooling	dB(A)	P-Hi: 44 Hi: 40 Me: 35 Lo: 27		
	Heating		51		
Silent mode sound pressure level	Cooling	dB(A)	—		
	Heating		49 / 47(Normal/Silent) 46.5 / 45.5(Normal/Silent)		
Exterior dimensions (Height x Width x Depth)			mm	Unit 248 × 570 × 570 Panel 10 × 620 × 620	750 × 880(+88) × 340
Exterior appearance (Munsell color) (RAL color)				Fine snow (8.0Y9.3/0.1) near equivalent (RAL 9001) near equivalent	Stucco white (4.2Y7.5/1.1) near equivalent (RAL 7044) near equivalent
Net weight			kg	Unit 14 Panel 2.5	60
Compressor type & Q'ty				—	RMT5118SWP1 x 1
Compressor motor (Starting method)			kW	—	Direct line start
Refrigerant oil (Amount, type)			L	—	0.675 (DIAMOND FREEZE MB75)
Refrigerant (Type, amount, pre-charge length)			kg	R32 2.75 in outdoor unit (Incl. the amount for the piping of 30m)	
Heat exchanger				Louver fin & inner grooved tubing	M shape fin & inner grooved tubing
Refrigerant control				Electronic expansion valve	
Fan type & Q'ty				Turbo fan x1	Propeller fan x1
Fan motor (Starting method)			W	50 < Direct line start >	86 < Direct line start >
Air flow	Cooling	m ³ /min	P-Hi: 13 Hi: 11 Me: 9 Lo: 7		60
	Heating				50
Available external static pressure			Pa	0	
Outside air intake				Possible	
Air filter, Quality / Quantity				Pocket plastic net x1(Washable)	
Shock & vibration absorber				Rubber sleeve (for fan motor)	Rubber sleeve (for compressor)
Electric heater			W	0	20(Crank case heater)
Operation control	Remote control			(Option) Wired : RC-EX3A , RC-E5 , RCH-E3 Wireless : RCN-TC-5AW-E2	
	Room temperature control			Thermostat by electronics	
	Operation display			—	
Safety equipments				Overload protection for fan motor Frost protection thermostat Internal thermostat for fan motor Abnormal discharge temperature protection.	
Installation data	Refrigerant piping size (O.D)	Liquid line	mm	I/U φ 6.35 (1/4") ② φ 9.52(3/8")x0.8 ① φ 9.52(3/8")x0.8 O/U φ 9.52 (3/8")	
		Gas line		I/U φ 12.7 (1/2") ② φ 12.7(1/2")x0.8 ① φ 15.88(5/8")x1.0 O/U φ 15.88 (5/8")	
	Connecting method			Flare piping	
	Attached length of piping		m	—	
	Insulation for piping			Necessary (both Liquid & Gas lines)	
	Refrigerant line (one way) length		m	Max.50m	
Vertical height diff. between O/U and I/U		m	Max.30m (Outdoor unit is higher) Max.15m (Outdoor unit is lower)		
Drain hose			Hose connectable with VP25 (O.D.32) Hole size φ 20 x 4 pcs		
Drain pump, max lift height			mm	Built-in drain pump , 850	
Recommended breaker size			A	—	
L.R.A. (Locked rotor ampere)			A	5.0	
Interconnecting wires		Size x Core number		φ 1.6mm x 3 cores (Including earth cable) / Terminal block (Screw fixing type)	
IP number				IPX0	IP24
Standard accessories				Mounting kit, Drain hose	
Option parts				OA Spacer : TC-OAS-E2 , TC-OAD-E , Motion sensor : LB-TC-5W-E	

Notes (1) The data are measured at the following conditions.

The pipe length is 7.5m.

Operation	Item	Indoor air temperature		Outdoor air temperature		Standards
		DB	WB	DB	WB	
Cooling		27°C	19°C	35°C	24°C	ISO5151-T1
		20°C	—	7°C	6°C	ISO5151-H1

(2) This air-conditioner is manufactured and tested in conformity with the ISO.

(3) Sound level indicates the value in an anechoic chamber. During operation these values are somewhat higher due to ambient conditions.

(4) Select the breaker size according to the own national standard.

(5) The operation data indicate when the air-conditioner is operated at 400V 50Hz or 380V 60Hz.

(6) Indoor unit specifications for one unit. Capacity and operation data is two indoor units are combined and run together.

(7) Branching pipe set "DIS-WA1G"x1(Option). ① : Pipe of O/U - Branch, ② : Pipe of Branch - I/U

(3) Duct connected-High static pressure type (FDU)
Single type

Item		Model	FDU71VNXWVH		
			Indoor unit FDU71VH	Outdoor unit FDC71VNX-W	
Power source			1 Phase, 220-240V 50Hz / 220V 60Hz		
Operation data	Nominal cooling capacity (range)	kW	7.1 [3.2(Min.) - 8.0(Max.)]		
	Nominal heating capacity (range)	kW	8.0 [3.6(Min.) - 9.0(Max.)]		
	Power consumption	Cooling	kW	1.77	
		Heating		1.78	
	Max power consumption		4.11		
	Running current	Cooling	A	7.9 / 8.3	
		Heating		7.9 / 8.3	
	Inrush current, max current		5, 20		
	Power factor	Cooling	%	98	
		Heating		98	
	EER	Cooling		4.01	
	COP	Heating		4.49	
	Sound power level	Cooling	dB(A)	65	66
		Heating			
Sound pressure level	Cooling	dB(A)	P-Hi: 38 Hi: 33 Me: 29 Lo: 25	51	
	Heating			51	
Silent mode sound pressure level	Cooling	dB(A)	—	49 / 47(Normal/Silent)	
	Heating		—	46.5 / 45.5(Normal/Silent)	
Exterior dimensions (Height x Width x Depth)		mm	280 × 950 × 635	750 × 880(+88) × 340	
Exterior appearance (Munsell color) (RAL color)			—	Stucco white (4.2Y7.5/1.1) near equivalent (RAL 7044) near equivalent	
Net weight		kg	34	60	
Compressor type & Q'ty			—	RMT5118SWP1 x 1	
Compressor motor (Starting method)		kW	—	Direct line start	
Refrigerant oil (Amount, type)		L	—	0.675 (DIAMOND FREEZE MB75)	
Refrigerant (Type, amount, pre-charge length)		kg	R32 2.75 in outdoor unit (Incl. the amount for the piping of 30m)		
Heat exchanger			Louver fin & inner grooved tubing	M shape fin & inner grooved tubing	
Refrigerant control			Electronic expansion valve		
Fan type & Q'ty			Centrifugal fan x2	Propeller fan x1	
Fan motor (Starting method)		W	130 < Direct line start >	86 < Direct line start >	
Air flow	Cooling	m³/min	P-Hi: 24 Hi: 19 Me: 15 Lo: 10	60	
	Heating			50	
Available external static pressure		Pa	Standard: 35 Max: 200	—	
Outside air intake			Possible	—	
Air filter, Quality / Quantity			Procure locally	—	
Shock & vibration absorber			Rubber sleeve (for fan motor)	Rubber sleeve (for compressor)	
Electric heater		W	—	20(Crank case heater)	
Operation control	Remote control		(Option) Wired : RC-EX3A , RC-E5 , RCH-E3 Wireless : RCN-KIT4-E2		
	Room temperature control		Thermostat by electronics		
	Operation display		—		
Safety equipments			Overload protection for fan motor Frost protection thermostat Internal thermostat for fan motor Abnormal discharge temperature protection.		
Installation data	Refrigerant piping size (O.D)	Liquid line	I/U φ 9.52 (3/8") Pipe φ 9.52(3/8")x0.8 O/U φ 9.52 (3/8")		
		Gas line	φ 15.88 (5/8") φ 15.88(5/8")x1.0 φ 15.88 (5/8")		
	Connecting method		Flare piping	Flare piping	
	Attached length of piping	m	—	—	
	Insulation for piping		Necessary (both Liquid & Gas lines)		
	Refrigerant line (one way) length	m	Max.50m		
Vertical height diff. between O/U and I/U	m	Max.30m (Outdoor unit is higher)	Max.15m (Outdoor unit is lower)		
Drain hose		Hose connectable VP25 (I.D.25, O.D.32)	Hole size φ 20 x 4 pcs		
Drain pump, max lift height		mm	Built-in drain pump , 600	—	
Recommended breaker size		A	—		
L.R.A. (Locked rotor ampere)		A	5.0		
Interconnecting wires		Size x Core number	φ 1.6mm x 3 cores + earth cable / Terminal block (Screw fixing type)		
IP number			IPX0	IP24	
Standard accessories			Mounting kit, Drain hose	—	
Option parts			Motion sensor : LB-KIT		

Notes (1) The data are measured at the following conditions.

The pipe length is 7.5m.

Operation	Item	Indoor air temperature		Outdoor air temperature		External static pressure of indoor unit	Standards
		DB	WB	DB	WB		
Cooling		27°C	19°C	35°C	24°C	60Pa	ISO5151-T1
		20°C	—	7°C	6°C		ISO5151-H1

(2) This air-conditioner is manufactured and tested in conformity with the ISO.

(3) Sound level indicates the value in an anechoic chamber. During operation these values are somewhat higher due to ambient conditions.

(4) Select the breaker size according to the own national standard.

(5) When wireless remote control is used, fan is 3 speed setting (Hi-Me-Lo) only.

(6) The operation data indicate when the air-conditioner is operated at 230V 50Hz or 220V 60Hz.

(7) The factory E.S.P. setting is set within the range of 80 - 150 Pa.If SW8-4 is turned to "ON", E.S.P. setting range can be changed to 10 - 200 Pa.(For RC-EX3A and RC-E5 only)

(4) Duct connected-Low/Middle static pressure type (FDUM)

Single type

Item		Model	FDUM71VNXWVH				
			Indoor unit FDUM71VH	Outdoor unit FDC71VNX-W			
Power source			1 Phase, 220-240V 50Hz / 220V 60Hz				
Operation data	Nominal cooling capacity (range)	kW	7.1 [3.2(Min.) - 8.0(Max.)]				
	Nominal heating capacity (range)	kW	8.0 [3.6(Min.) - 9.0(Max.)]				
	Power consumption	Cooling	kW	1.77			
		Heating		1.78			
	Max power consumption		4.11				
	Running current	Cooling	A	7.9 / 8.3			
		Heating		7.9 / 8.3			
	Inrush current, max current		5, 20				
	Power factor	Cooling	%	98			
		Heating		98			
	EER	Cooling		4.01			
	COP	Heating		4.49			
	Sound power level	Cooling	dB(A)	65	66		
		Heating		66			
Sound pressure level	Cooling	dB(A)	P-Hi: 38 Hi: 33 Me: 29 Lo: 25				
	Heating		51				
Silent mode sound pressure level	Cooling	dB(A)	—				
	Heating		49 / 47(Normal/Silent)				
Exterior dimensions (Height x Width x Depth)		mm	280 × 950 × 635	750 × 880(+88) × 340			
Exterior appearance (Munsell color) (RAL color)			—	Stucco white (4.2Y7.5/1.1) near equivalent (RAL 7044) near equivalent			
Net weight		kg	34	60			
Compressor type & Q'ty			—	RMT5118SWP1 x 1			
Compressor motor (Starting method)		kW	—	Direct line start			
Refrigerant oil (Amount, type)		L	—	0.675 (DIAMOND FREEZE MB75)			
Refrigerant (Type, amount, pre-charge length)		kg	R32 2.75 in outdoor unit (Incl. the amount for the piping of 30m)				
Heat exchanger			Louver fin & inner grooved tubing	M shape fin & inner grooved tubing			
Refrigerant control			Electronic expansion valve				
Fan type & Q'ty			Centrifugal fan x2	Propeller fan x1			
Fan motor (Starting method)		W	130 < Direct line start >	86 < Direct line start >			
Air flow	Cooling	m ³ /min	P-Hi: 24 Hi: 19 Me: 15 Lo: 10				
	Heating		60				
Available external static pressure		Pa	Standard: 35 Max: 100	—			
Outside air intake			Possible	—			
Air filter, Quality / Quantity			Procure locally	—			
Shock & vibration absorber			Rubber sleeve (for fan motor)	Rubber sleeve (for compressor)			
Electric heater		W	—	20(Crank case heater)			
Operation control	Remote control		(Option) Wired : RC-EX3A , RC-E5 , RCH-E3 Wireless : RCN-KIT4-E2				
	Room temperature control		Thermostat by electronics				
	Operation display		—				
Safety equipments			Overload protection for fan motor Frost protection thermostat Internal thermostat for fan motor Abnormal discharge temperature protection.				
Installation data	Refrigerant piping size (O.D)	Liquid line	I/U φ 9.52 (3/8") Pipe φ 9.52(3/8")x0.8 O/U φ 9.52 (3/8")				
		Gas line	φ 15.88 (5/8") φ 15.88(5/8")x1.0 φ 15.88 (5/8")				
	Connecting method		Flare piping	Flare piping			
	Insulation for piping		Necessary (both Liquid & Gas lines)				
	Refrigerant line (one way) length	m	Max.50m				
Vertical height diff. between O/U and I/U	m	Max.30m (Outdoor unit is higher)	Max.15m (Outdoor unit is lower)				
Drain hose		Hose connectable VP25 (I.D.25, O.D.32)	Hole size φ 20 x 4 pcs				
Drain pump, max lift height		mm	Built-in drain pump , 600	—			
Recommended breaker size		A	—				
L.R.A. (Locked rotor ampere)		A	5.0				
Interconnecting wires		Size x Core number	φ 1.6mm x 3 cores + earth cable / Terminal block (Screw fixing type)				
IP number			IPX0	IP24			
Standard accessories			Mounting kit, Drain hose	—			
Option parts			Filter set : UM-FL2EF, Motion sensor : LB-KIT				
Notes (1) The data are measured at the following conditions. The pipe length is 7.5m.							
Operation	Item	Indoor air temperature		Outdoor air temperature		External static pressure of indoor unit	Standards
		DB	WB	DB	WB		
	Cooling	27°C	19°C	35°C	24°C		
Heating	20°C	—	7°C	6°C		ISO5151-H1	
(2) This air-conditioner is manufactured and tested in conformity with the ISO. (3) Sound level indicates the value in an anechoic chamber. During operation these values are somewhat higher due to ambient conditions. (4) Select the breaker size according to the own national standard. (5) The operation data indicate when the air-conditioner is operated at 230V 50Hz or 220V 60Hz. (6) Static pressure of option air filter "UM-FL2EF" is 5Pa initially. (7) The external static pressure setting can be changed to 10-100Pa. (For RC-EX3A and RC-E5 only)							

Twin type

Item		Model	FDUM71VNXWPVH		
			Indoor unit FDUM40VH (2 units)	Outdoor unit FDC71VNX-W	
Power source			1 Phase, 220 - 240V 50Hz / 220V 60Hz		
Operation data	Nominal cooling capacity (range)	kW	7.1 [3.2(Min.) - 8.0(Max.)]		
	Nominal heating capacity (range)	kW	8.0 [3.6(Min.) - 9.0(Max.)]		
	Power consumption	Cooling	kW	1.76	
		Heating		1.80	
	Max power consumption		4.11		
	Running current	Cooling	A	7.8 / 8.2	
		Heating		8.0 / 8.4	
	Inrush current, max current		5, 20		
	Power factor	Cooling	%	98	
		Heating		98	
	EER	Cooling		4.03	
	COP	Heating		4.44	
	Sound power level	Cooling	dB(A)	60	66
		Heating		P-Hi: 37 Hi: 32 Me: 29 Lo: 26	
Sound pressure level	Cooling		51		
	Heating		51		
Silent mode sound pressure level	Cooling		49 / 47(Normal/Silent)		
	Heating		46.5 / 45.5(Normal/Silent)		
Exterior dimensions (Height x Width x Depth)		mm	280 × 950 × 635	750 × 880(+88) × 340	
Exterior appearance (Munsell color) (RAL color)			—	Stucco white (4.2Y7.5/1.1) near equivalent (RAL 7044) near equivalent	
Net weight		kg	29	60	
Compressor type & Q'ty			—	RMT5118SWP1 x 1	
Compressor motor (Starting method)		kW	—	Direct line start	
Refrigerant oil (Amount, type)		L	—	0.675 (DIAMOND FREEZE MB75)	
Refrigerant (Type, amount, pre-charge length)		kg	R32 2.75 in outdoor unit (Incl. the amount for the piping of 30m)		
Heat exchanger			Louver fin & inner grooved tubing	M shape fin & inner grooved tubing	
Refrigerant control			Electronic expansion valve		
Fan type & Q'ty			Centrifugal fan x2	Propeller fan x1	
Fan motor (Starting method)		W	100 < Direct line start >	86 < Direct line start >	
Air flow	Cooling	m ³ /min	P-Hi: 13 Hi: 10 Me: 9 Lo: 8		
	Heating		60		
Available external static pressure		Pa	Standard: 35 Max: 100	—	
Outside air intake			Possible	—	
Air filter, Quality / Quantity			Procure locally	—	
Shock & vibration absorber			Rubber sleeve (for fan motor)	Rubber sleeve (for compressor)	
Electric heater		W	—	20(Crank case heater)	
Operation control	Remote control		(Option) Wired : RC-EX3A , RC-E5 , RCH-E3 Wireless : RCN-KIT4-E2		
	Room temperature control		Thermostat by electronics		
	Operation display		—		
Safety equipments			Overload protection for fan motor Frost protection thermostat Internal thermostat for fan motor Abnormal discharge temperature protection.		
Installation data	Refrigerant piping size (O.D)	Liquid line	I/U φ 6.35 (1/4") ② φ 9.52(3/8")x0.8 ① φ 9.52(3/8")x0.8 O/U φ 9.52 (3/8")		
		Gas line	φ 12.7 (1/2") ② φ 12.7(1/2")x0.8 ① φ 15.88(5/8")x1.0 O/U φ 15.88 (5/8")		
	Connecting method		Flare piping	Flare piping	
	Insulation for piping		Necessary (both Liquid & Gas lines)		
	Refrigerant line (one way) length	m	Max.50m		
Vertical height diff. between O/U and I/U		m	Max.30m (Outdoor unit is higher)	Max.15m (Outdoor unit is lower)	
Drain hose			Hose connectable VP25 (I.D.25, O.D.32)	Hole size φ 20 x 4 pcs	
Drain pump, max lift height		mm	Built-in drain pump , 600	—	
Recommended breaker size		A	—		
L.R.A. (Locked rotor ampere)		A	5.0		
Interconnecting wires		Size x Core number	φ 1.6mm x 3 cores + earth cable / Terminal block (Screw fixing type)		
IP number			IPX0	IP24	
Standard accessories			Mounting kit, Drain hose	—	
Option parts			Filter set : UM-FL2EF , Motion sensor : LB-KIT		

Notes (1) The data are measured at the following conditions.

The pipe length is 7.5m.

Operation	Item	Indoor air temperature		Outdoor air temperature		External static pressure of indoor unit	Standards
		DB	WB	DB	WB		
Cooling		27°C	19°C	35°C	24°C	35Pa	ISO5151-T1
		20°C	—	7°C	6°C		
Heating		20°C	—	7°C	6°C		ISO5151-H1

(2) This air-conditioner is manufactured and tested in conformity with the ISO.

(3) Sound level indicates the value in an anechoic chamber. During operation these values are somewhat higher due to ambient conditions.

(4) Select the breaker size according to the own national standard.

(5) The operation data indicate when the air-conditioner is operated at 230V 50Hz or 220V 60Hz.

(6) Static pressure of option air filter "UM-FL2EF" is 5Pa initially.

(7) The external static pressure setting can be changed to 10-100Pa. (For RC-EX3A and RC-E5 only)

(5) Ceiling suspended type (FDE)
Single type

Item		Model	FDE71VNXWVH			
			Indoor unit FDE71VH	Outdoor unit FDC71VNX-W		
Power source			1 Phase, 220 - 240V 50Hz / 220V 60Hz			
Operation data	Nominal cooling capacity (range)	kW	7.1 [3.2(Min.) - 8.0(Max.)]			
	Nominal heating capacity (range)	kW	8.0 [3.6(Min.) - 9.0(Max.)]			
	Power consumption	Cooling	kW	1.87		
		Heating		1.87		
	Max power consumption		4.11			
	Running current	Cooling	A	8.3 / 8.7		
		Heating		8.3 / 8.7		
	Inrush current, max current		5, 19.1			
	Power factor	Cooling	%	98		
		Heating		98		
	EER	Cooling		3.80		
	COP	Heating		4.28		
	Sound power level	Cooling	dB(A)	60	66	
		Heating				
Sound pressure level	Cooling	dB(A)	P-Hi: 47 Hi: 41 Me: 37 Lo: 32			
	Heating					
Silent mode sound pressure level	Cooling	dB(A)	—			
	Heating		49 / 47(Normal/Silent)			
Exterior dimensions (Height x Width x Depth)		mm	210 × 1,320 × 690			
Exterior appearance (Munsell color) (RAL color)			Plaster white (6.8Y8.9/0.2) near equivalent (RAL 9003) near equivalent			
Net weight		kg	33			
Compressor type & Q'ty			—			
Compressor motor (Starting method)		kW	—			
Refrigerant oil (Amount, type)		L	—			
Refrigerant (Type, amount, pre-charge length)		kg	R32 2.75 in outdoor unit (Incl. the amount for the piping of 30m)			
Heat exchanger			Louver fin & inner grooved tubing			
Refrigerant control			Capillary tubes + Electronic expansion valve			
Fan type & Q'ty			Centrifugal fan ×4			
Fan motor (Starting method)		W	50 < Direct line start >			
Air flow	Cooling	m ³ /min	P-Hi: 20 Hi: 16 Me: 13 Lo: 10			
	Heating		60			
Available external static pressure		Pa	0			
Outside air intake			Not possible			
Air filter, Quality / Quantity			Pocket plastic net x2(Washable)			
Shock & vibration absorber			Rubber sleeve (for fan motor)			
Electric heater		W	—			
Operation control	Remote control		(Option) Wired : RC-EX3A , RC-E5 , RCH-E3 Wireless : RCN-E-E3			
	Room temperature control		Thermostat by electronics			
	Operation display		—			
Safety equipments			Overload protection for fan motor Frost protection thermostat Internal thermostat for fan motor Abnormal discharge temperature protection.			
Installation data	Refrigerant piping size (O.D)	Liquid line	I/U φ 9.52 (3/8") Pipe φ 9.52(3/8")x0.8 O/U φ 9.52 (3/8")			
		Gas line	φ 15.88 (5/8") φ 15.88(5/8")x1.0 φ 15.88 (5/8")			
	Connecting method		Flare piping			
	Insulation for piping		Necessary (both Liquid & Gas lines)			
	Refrigerant line (one way) length	m	Max.50m			
Vertical height diff. between O/U and I/U	m	Max.30m (Outdoor unit is higher)				
Drain hose		Hose connectable with VP20 (O.D.26)				
Drain pump, max lift height	mm	—				
Recommended breaker size	A	—				
L.R.A. (Locked rotor ampere)	A	5.0				
Interconnecting wires	Size x Core number	φ 1.6mm x 3 cores + earth cable / Terminal block (Screw fixing type)				
IP number		IPX0				
Standard accessories		Mounting kit, Drain hose				
Option parts		Motion sensor : LB-E				
Notes (1) The data are measured at the following conditions. The pipe length is 7.5m.						
Operation	Item	Indoor air temperature		Outdoor air temperature		Standards
		DB	WB	DB	WB	
	Cooling	27°C	19°C	35°C	24°C	
Heating	20°C	—	7°C	6°C	ISO5151-H1	

- (2) This air-conditioner is manufactured and tested in conformity with the ISO.
- (3) Sound level indicates the value in an anechoic chamber. During operation these values are somewhat higher due to ambient conditions.
- (4) Select the breaker size according to the own national standard.
- (5) The operation data indicate when the air-conditioner is operated at 230V 50Hz or 220V 60Hz.

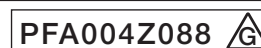

Twin type

Item		Model	FDE71VNXWPHVH		
			Indoor unit FDE40VH (2 units)	Outdoor unit FDC71VNX-W	
Power source			1 Phase, 220 - 240V 50Hz / 220V 60Hz		
Operation data	Nominal cooling capacity (range)	kW	7.1 [3.2(Min.) - 8.0(Max.)]		
	Nominal heating capacity (range)	kW	8.0 [3.6(Min.) - 9.0(Max.)]		
	Power consumption	Cooling	kW	1.76	
		Heating		2.10	
	Max power consumption		4.11		
	Running current	Cooling	A	7.8 / 8.2	
		Heating		9.3 / 9.8	
	Inrush current, max current		5, 19.1		
	Power factor	Cooling	%	98	
		Heating		98	
	EER	Cooling		4.03	
	COP	Heating		3.81	
	Sound power level	Cooling	dB(A)	60	66
		Heating		P-Hi: 46 Hi: 38 Me: 36 Lo: 31	
Sound pressure level	Cooling		51		
	Heating		51		
Silent mode sound pressure level	Cooling		49 / 47(Normal/Silent)		
	Heating		46.5 / 45.5(Normal/Silent)		
Exterior dimensions (Height x Width x Depth)		mm	210 × 1,070 × 690		
Exterior appearance (Munsell color) (RAL color)			Plaster white (6.8Y8.9/0.2) near equivalent (RAL 9003) near equivalent		
			Stucco white (4.2Y7.5/1.1) near equivalent (RAL 7044) near equivalent		
Net weight		kg	28		
Compressor type & Q'ty			—		
Compressor motor (Starting method)		kW	—		
Refrigerant oil (Amount, type)		L	—		
Refrigerant (Type, amount, pre-charge length)		kg	R32 2.75 in outdoor unit (Incl. the amount for the piping of 30m)		
Heat exchanger			Louver fin & inner grooved tubing	M shape fin & inner grooved tubing	
Refrigerant control			Electronic expansion valve		
Fan type & Q'ty			Centrifugal fan x2	Propeller fan x1	
Fan motor (Starting method)		W	30 < Direct line start >	86 < Direct line start >	
Air flow	Cooling	m ³ /min	P-Hi: 13 Hi: 10 Me: 9 Lo: 7		
	Heating		60		
Available external static pressure		Pa	0		
Outside air intake			Not possible		
Air filter, Quality / Quantity			Pocket plastic net x2(Washable)		
Shock & vibration absorber			Rubber sleeve (for fan motor)		
			Rubber sleeve (for compressor)		
Electric heater		W	—		
Operation control			(Option) Wired : RC-EX3A , RC-E5 , RCH-E3 Wireless : RCN-E-E3		
Remote control			Thermostat by electronics		
Room temperature control			—		
Operation display			—		
Safety equipments			Overload protection for fan motor Frost protection thermostat Internal thermostat for fan motor Abnormal discharge temperature protection.		
Installation data	Refrigerant piping size (O.D)	Liquid line	I/U φ 6.35 (1/4") Pipe ② φ 9.52(3/8")x0.8 ① φ 9.52(3/8")x0.8 O/U φ 9.52 (3/8")		
		Gas line	φ 12.7 (1/2") ② φ 12.7(1/2")x0.8 ① φ 15.88(5/8")x1.0 φ 15.88 (5/8")		
	Connecting method		Flare piping	Flare piping	
	Insulation for piping		Necessary (both Liquid & Gas lines)		
	Refrigerant line (one way) length	m	Max.50m		
Vertical height diff. between O/U and I/U	m	Max.30m (Outdoor unit is higher)			
Drain hose		Hose connectable with VP20 (O.D.26)			
Drain pump, max lift height	mm	—			
Recommended breaker size	A	—			
L.R.A. (Locked rotor ampere)	A	5.0			
Interconnecting wires	Size x Core number	φ 1.6mm x 3 cores + earth cable / Terminal block (Screw fixing type)			
IP number		IPX0			
Standard accessories		Mounting kit, Drain hose			
Option parts		Motion sensor : LB-E			

Notes (1) The data are measured at the following conditions.

The pipe length is 7.5m.

Operation	Indoor air temperature		Outdoor air temperature		Standards
	DB	WB	DB	WB	
Cooling	27°C	19°C	35°C	24°C	ISO5151-T1
Heating	20°C	—	7°C	6°C	ISO5151-H1

(2) This air-conditioner is manufactured and tested in conformity with the ISO.

(3) Sound level indicates the value in an anechoic chamber. During operation these values are somewhat higher due to ambient conditions.

(4) Select the breaker size according to the own national standard.

(5) The operation data indicate when the air-conditioner is operated at 230V 50Hz or 220V 60Hz.

PFA004Z088 

**(6) Wall mounted type (SRK)
Single type**

Item		Model	SRK71VNXWZR		
			Indoor unit SRK71ZR-W	Outdoor unit FDC71VNX-W	
Power source			1 Phase, 220-240V 50Hz / 220V 60Hz		
Operation data	Nominal cooling capacity (range)	kW	7.1 [3.2(Min.) - 8.0(Max.)]		
	Nominal heating capacity (range)	kW	8.0 [3.6(Min.) - 9.0(Max.)]		
	Power consumption	Cooling	kW	1.93	
		Heating		1.78	
	Max power consumption		4.11		
	Running current	Cooling	A	8.6 / 9.0	
		Heating		7.9 / 8.3	
	Inrush current, max current		5, 19.1		
	Power factor	Cooling	%	98	
		Heating		98	
	EER	Cooling		3.68	
	COP	Heating		4.49	
	Sound power level	Cooling	dB(A)	57	
		Heating		60	
Sound pressure level	Cooling	dB(A)	Hi: 44 Me: 41 Lo: 37 ULo: 25		
	Heating		Hi: 46 Me: 39 Lo: 35 ULo: 28		
Silent mode sound pressure level	Cooling	dB(A)	—		
	Heating		—		
Exterior dimensions (Height x Width x Depth)		mm	339 × 1,197 × 262		
Exterior appearance (Munsell color) (RAL color)			Fine snow (8.0Y9.3/0.1) near equivalent (RAL 9003) near equivalent		
Net weight		kg	15.5		
Compressor type & Q'ty			—		
Compressor motor (Starting method)		kW	—		
Refrigerant oil (Amount, type)		L	—		
Refrigerant (Type, amount, pre-charge length)		kg	R32 2.75 in outdoor unit (Incl. the amount for the piping of 30m)		
Heat exchanger			Louver fin & inner grooved tubing		
Refrigerant control			Electronic expansion valve		
Fan type & Q'ty			Tangential fan x1		
Fan motor (Starting method)		W	56 < Direct line start >		
Air flow	Cooling	m ³ /min	Hi: 20.5 Me: 18.6 Lo: 16.2 ULo: 10.4		
	Heating		Hi: 25.0 Me: 19.8 Lo: 17.3 ULo: 13.3		
Available external static pressure		Pa	0		
Outside air intake			Not possible		
Air filter, Quality / Quantity			Polypropylene net (Washable) x 2		
Shock & vibration absorber			Rubber sleeve (for fan motor)		
Electric heater		W	—		
Operation control	Remote control		(Option) Wired : RC-EX3A , RC-E5 , RCH-E3 Interface kit : SC-BIKN2-E		
	Room temperature control		Thermostat by electronics		
	Operation display		RUN: Green , TIMER: Yellow , HI POWER: Green , 3D AUTO: Orange		
Safety equipments			Compressor overheat protection, Overcurrent protection Frost protection, Serial signal error protection, Indoor fan motor error protection Heating overload protection (High pressure control), Cooling overload protection		
Installation data	Refrigerant piping size (O.D)	Liquid line	I/U φ 9.52 (3/8") Pipe φ 9.52(3/8")x0.8 O/U φ 9.52 (3/8")		
		Gas line	φ 15.88 (5/8") φ 15.88(5/8")x1.0 φ 15.88 (5/8")		
	Connecting method		Flare piping		
	Attached length of piping	m	—		
	Insulation for piping		Necessary (both Liquid & Gas lines)		
	Refrigerant line (one way) length	m	Max.50m		
Vertical height diff. between O/U and I/U		m	Max.30m (Outdoor unit is higher)		
Drain hose			Hose connectable (VP16)		
Drain pump, max lift height		mm	—		
Recommended breaker size		A	—		
L.R.A. (Locked rotor ampere)		A	5.0		
Interconnecting wires		Size x Core number	1.5mm ² x 4 cores (Including earth cable) / Terminal block (Screw fixing type)		
IP number			IPX0		
Standard accessories			Mounting kit, Clean filter (Allergen clear filter x1 , Photocatalytic washable deodorizing filter x 1)		
Option parts			—		

Notes (1) The data are measured at the following conditions.

The pipe length is 7.5m.

Operation	Item	Indoor air temperature		Outdoor air temperature		Standards
		DB	WB	DB	WB	
Cooling		27°C	19°C	35°C	24°C	ISO5151-T1
		20°C	—	7°C	6°C	ISO5151-H1

(2) This air-conditioner is manufactured and tested in conformity with the ISO.

(3) Sound level indicates the value in an anechoic chamber. During operation these values are somewhat higher due to ambient conditions.

(4) Select the breaker size according to the own national standard.

(5) The operation data indicate when the air-conditioner is operated at 230V 50Hz or 220V 60Hz.

1.2 EXTERIOR DIMENSIONS

(1) Indoor units

(a) Ceiling cassette-4 way type (FDT)

Models FDT40VH, 71VH

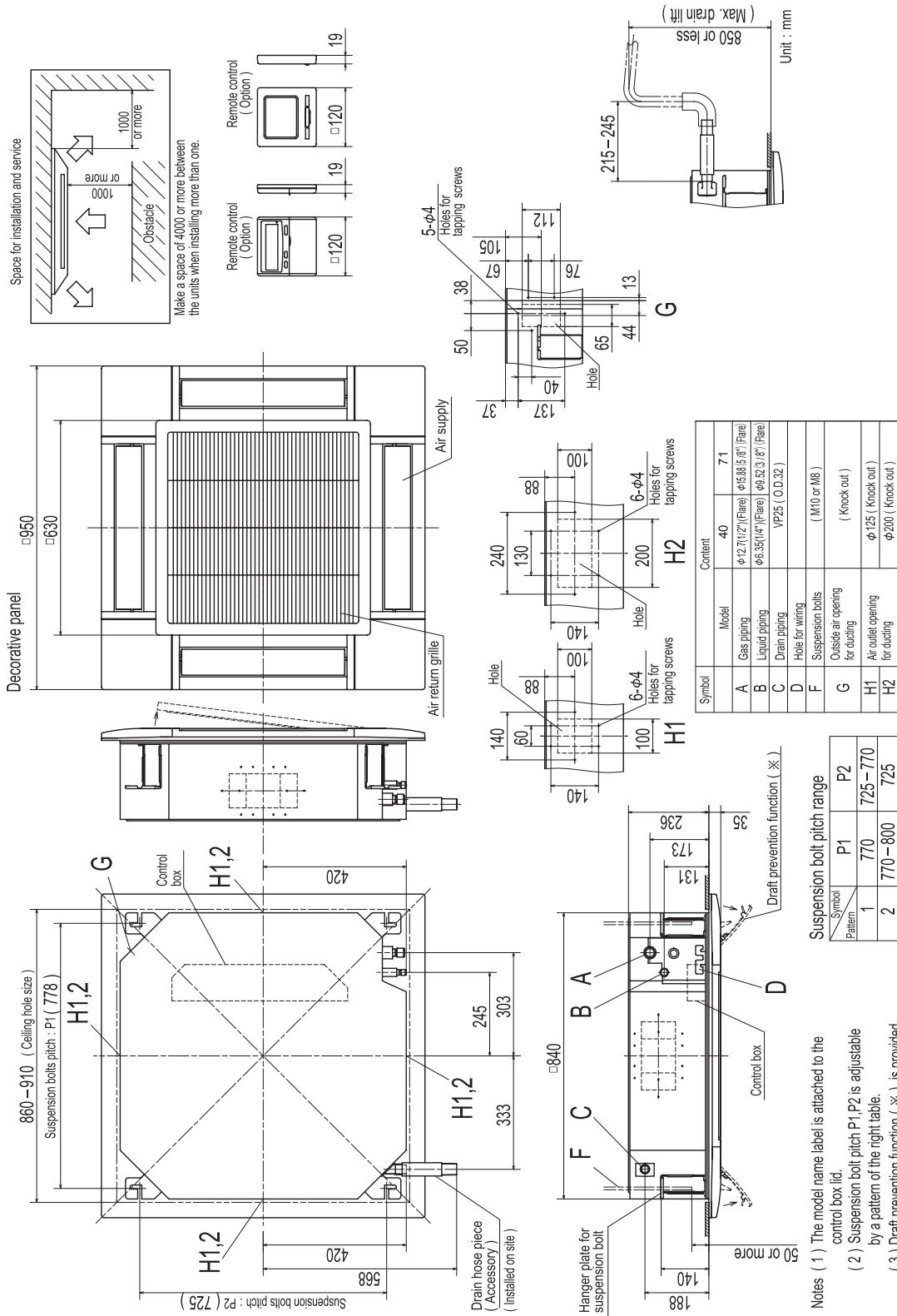

Notes (1) The model name label is attached to the control box lid.
 (2) Suspension bolt pitch P1, P2 is adjustable by a pattern of the right table.
 (3) Draft prevention function (※) is provided on the panel T-PSAE-SAW-E only.

PJF000Z552

(b) Ceiling cassette-4 way compact type (FDTC)
Model FDTC40VH

Symbol	Content
A	Gas piping φ12.7 (1/2") (Flare)
B	Liquid piping φ6.35 (1/4") (Flare)
C	Drain piping VP25 (O.D.32)
D1	Power source connection Remote control code and signal wiring connection
D2	Suspension bolts (M10 or M8)
F	Outside air opening for ducting (Knock out)
G	Air outlet opening for ducting φ125 (Knock out)
H	Inspection opening
J	450×450

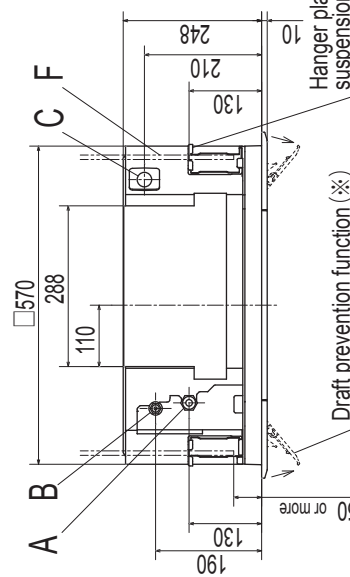
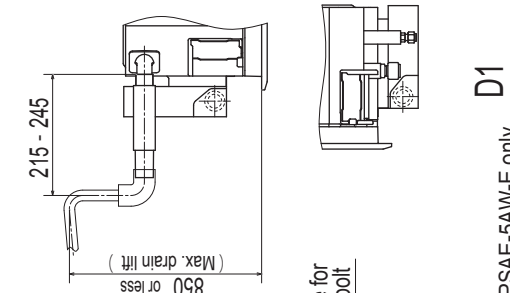
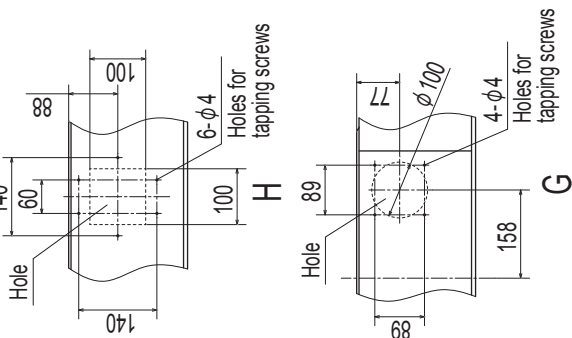
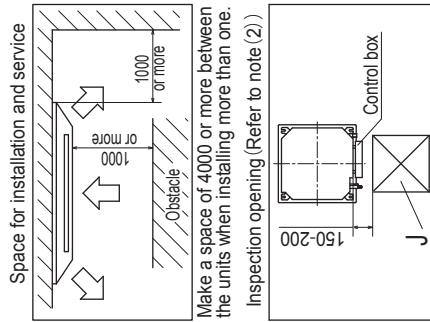
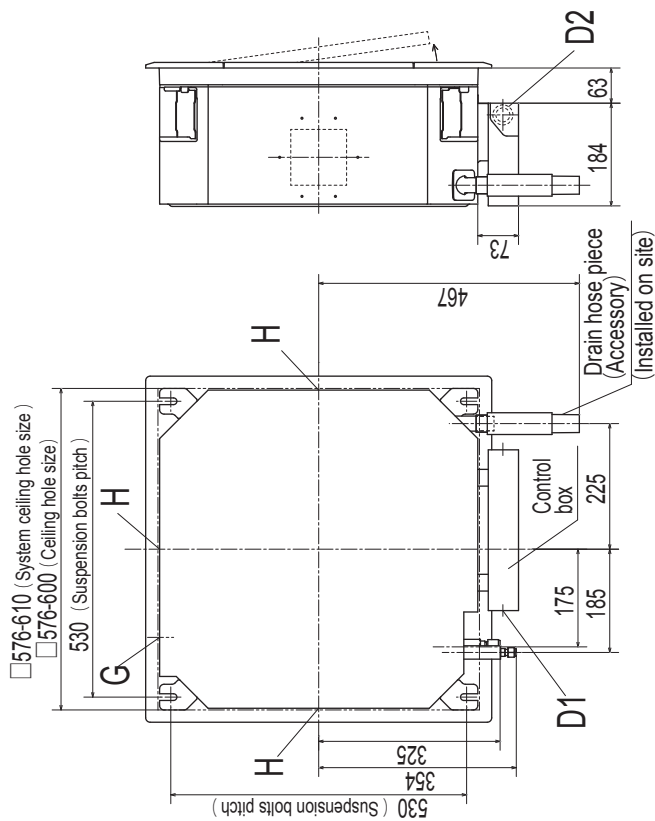
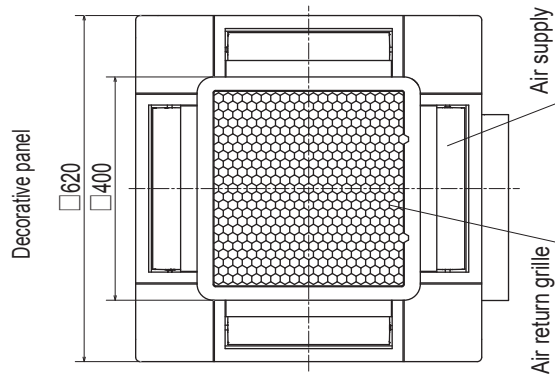

Unit: mm

- Notes
- (1) The model name label is attached to the control box lid.
 - (2) This unit is designed for 2x2 grid ceiling. If it is installed on a ceiling other than 2x2 grid ceiling, provide an inspection opening on the control box side.
 - (3) Draft prevention function (※) is provided on the panel TC-PSAE-5AW-E only.

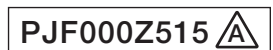

(c) Duct connected-High static pressure type (FDU)
Model FDU71VH

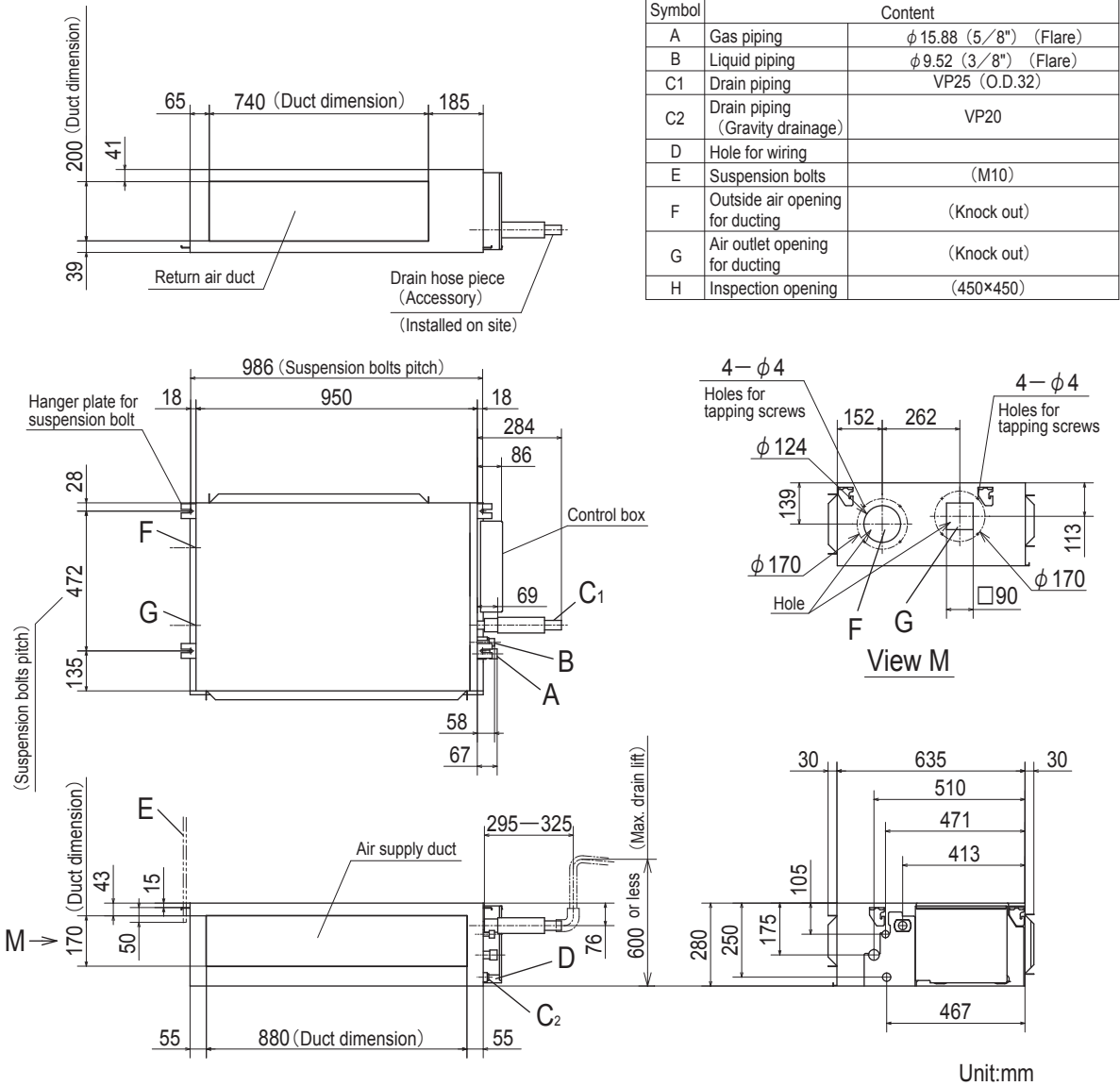

Symbol	Content	
A	Gas piping	φ 15.88 (5/8") (Flare)
B	Liquid piping	φ 9.52 (3/8") (Flare)
C1	Drain piping	VP25 (O.D.32)
C2	Drain piping (Gravity drainage)	VP20
D	Hole for wiring	
E	Suspension bolts	(M10)
F	Outside air opening for ducting	(Knock out)
G	Air outlet opening for ducting	(Knock out)
H	Inspection opening	(450×450)

Space for installation and service

Select either of two cases to keep space for installation and services.
 (Case 1) From side of unit

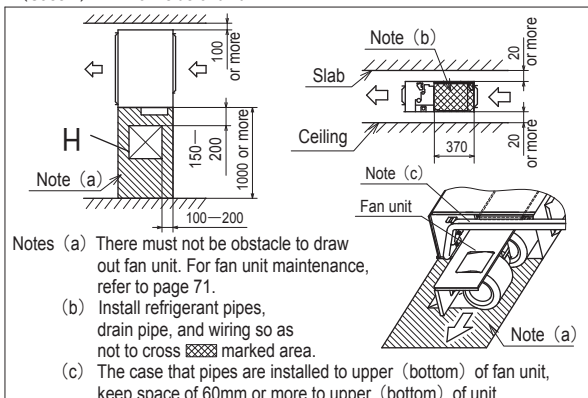

(Case 2) From bottom of unit

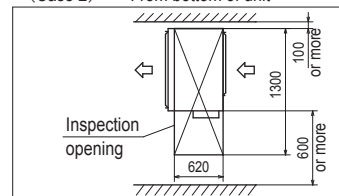

Note (1) The model name label is attached on the lid of the control box.

PJG000Z577

(d) Duct connected-Low / Middle static pressure type (FDUM)
Model FDUM40VH

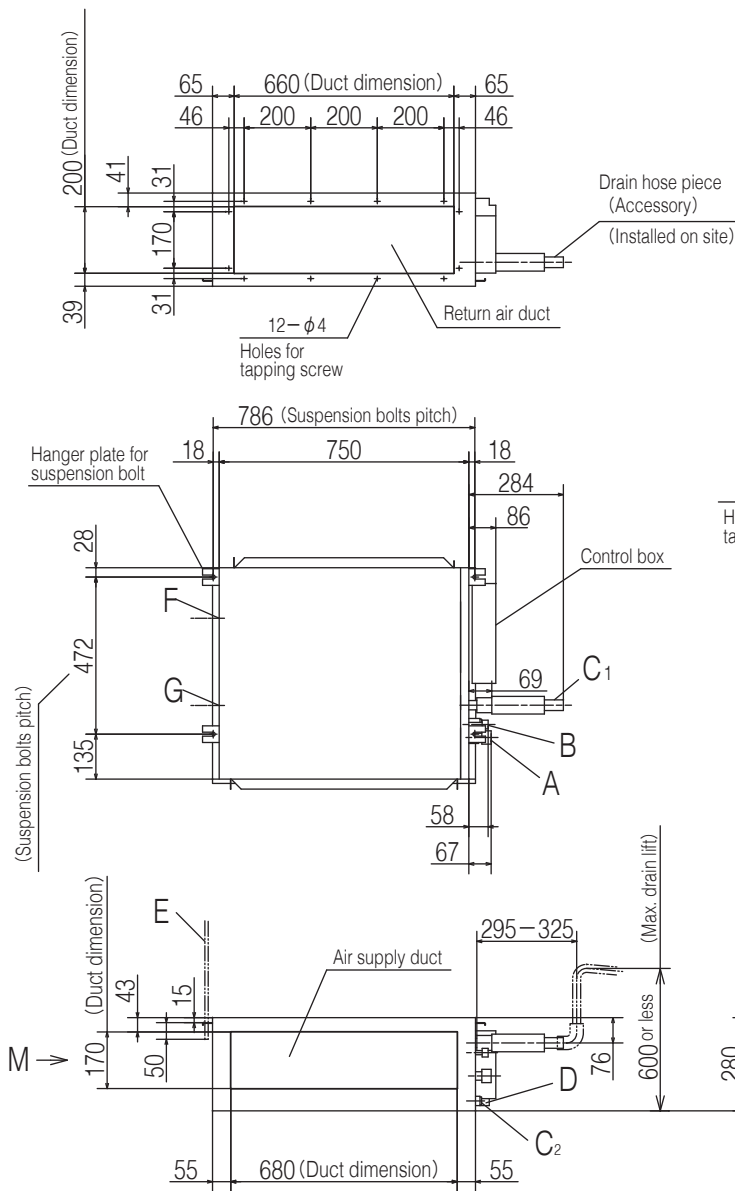

Symbol	Content	
A	Gas piping	φ 12.7 (1/2") (Flare)
B	Liquid piping	φ 6.35 (1/4") (Flare)
C1	Drain piping	VP25 (O.D.32)
C2	Drain piping (Gravity drainage)	VP20
D	Hole for wiring	
E	Suspension bolts	(M10)
F	Outside air opening for ducting	(φ 150) (Knock out)
G	Air outlet opening for ducting	(φ 125) (Knock out)
H	Inspection opening	(450 × 450)

Note (1) The model name label is attached on the lid of the control box.

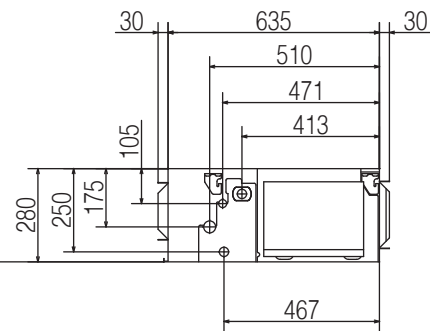
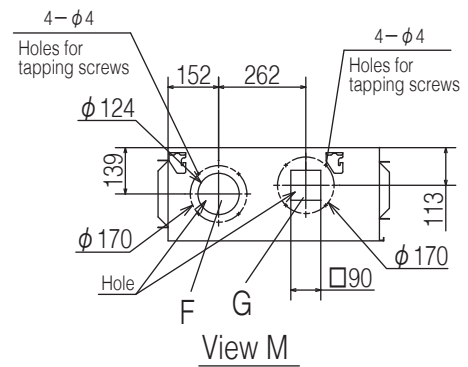

Unit:mm

Space for installation and service

Select either of two cases to keep space for installation and services.
 (Case 1) From side of unit

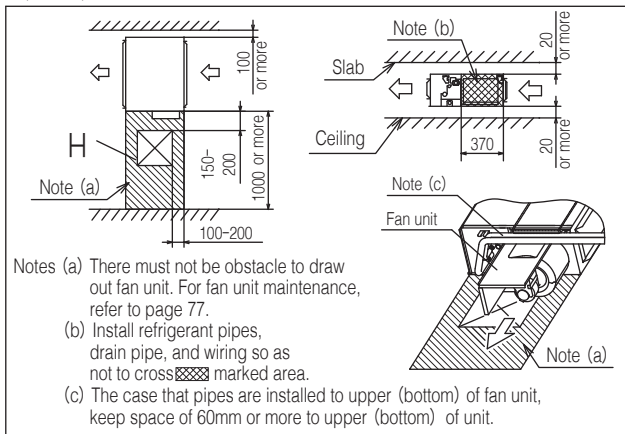

(Case 2) From bottom of unit

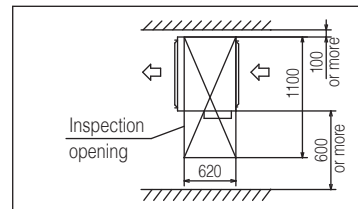

PJG000Z485

Model FDUM71VH

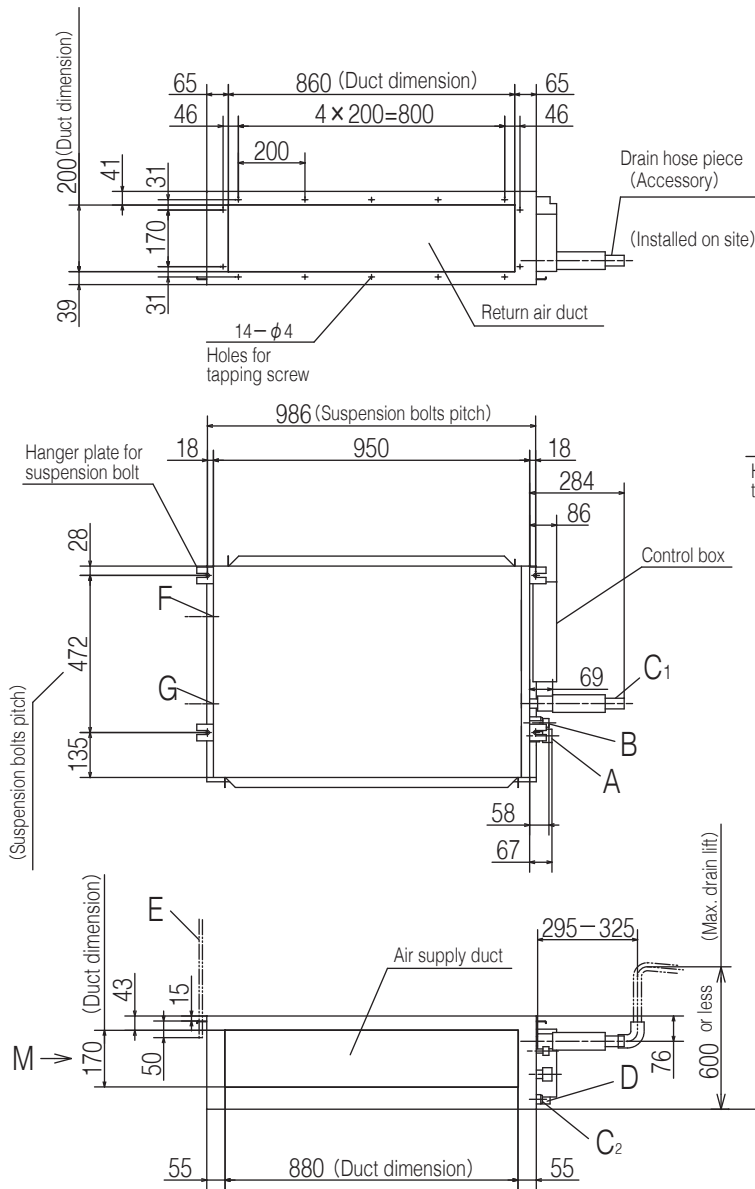

Symbol	Content	
	Model	71
A	Gas piping	φ 15.88 (5/8") (Flare)
B	Liquid piping	φ 9.52 (3/8") (Flare)
C1	Drain piping	VP25 (O.D.32)
C2	Drain piping (Gravity drainage)	VP20
D	Hole for wiring	
E	Suspension bolts	(M10)
F	Outside air opening for ducting	(φ 150) (Knock out)
G	Air outlet opening for ducting	(φ 125) (Knock out)
H	Inspection opening	(450x450)

Note (1) The model name label is attached on the lid of the control box.

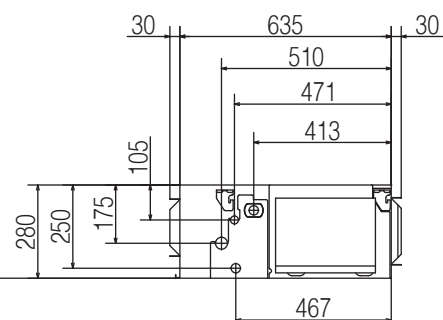
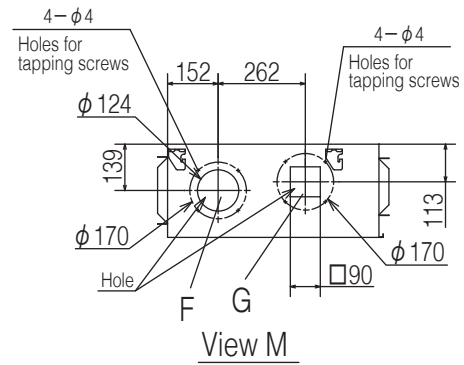

Space for installation and service

Select either of two cases to keep space for installation and services.

(Case 1) From side of unit

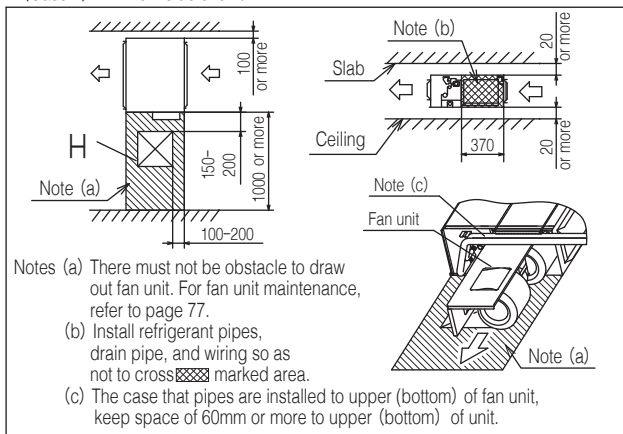

(Case 2) From bottom of unit

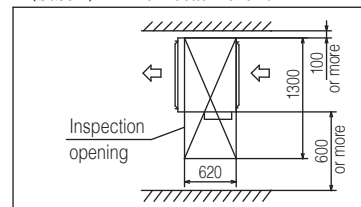

PJG000Z486

(e) Ceiling suspended type (FDE)
Model FDE40VH

Note (1) The model name label is attached on the fan casing inside the air return grille.

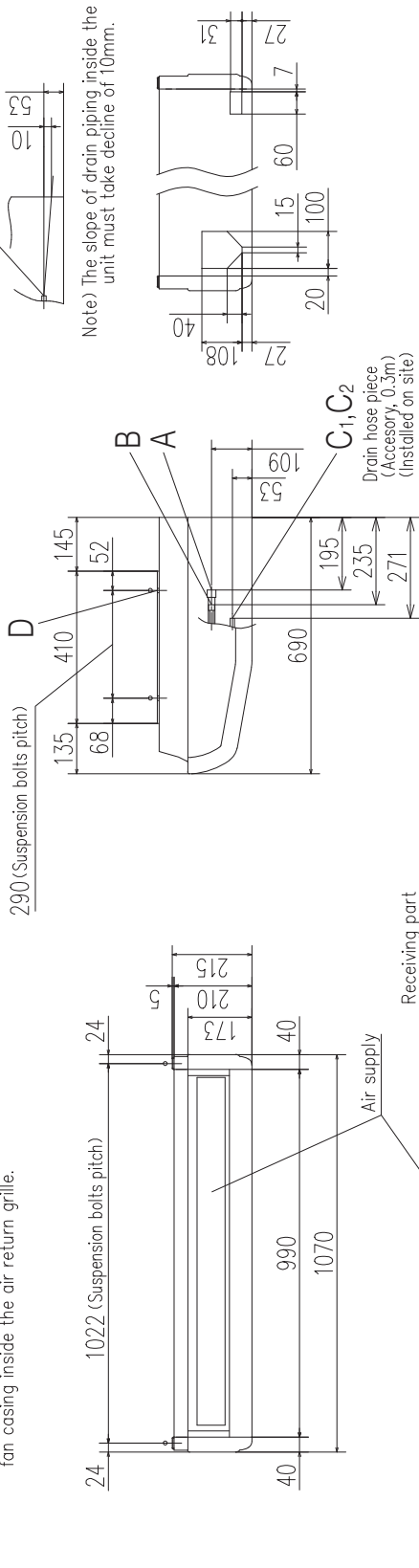

Symbol	Content
A	Gas piping
B	Liquid piping
C 1,2	Drain piping
D	Hole for suspension bolts
E	Back cutout
F	Top cutout
G	Hole for drain piping (for left back)

Unit: mm

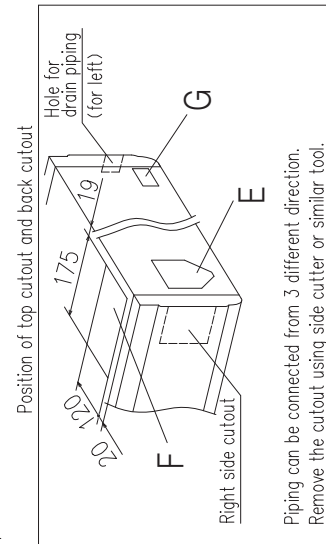

Piping can be connected from 3 different direction. Remove the cutout using side cutter or similar tool.

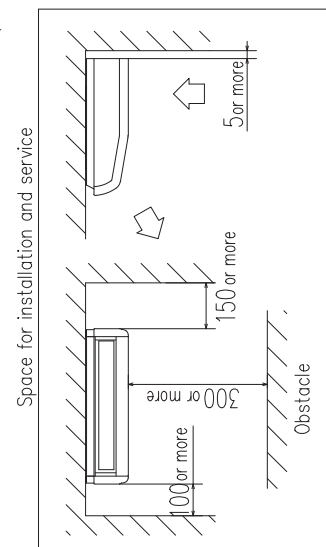

Make a space of 4000 or more between the units when installing more than one.

PFA004Z084

Model FDE71VH

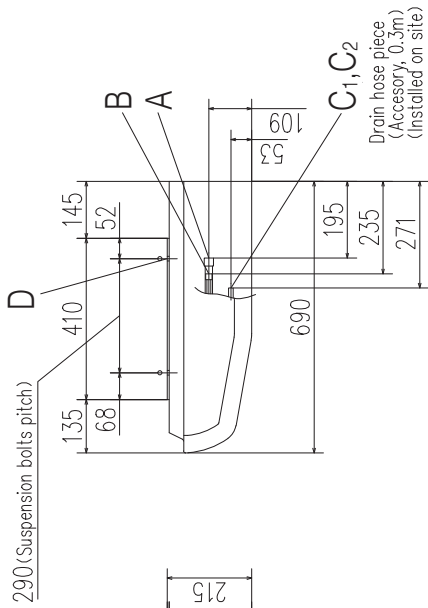
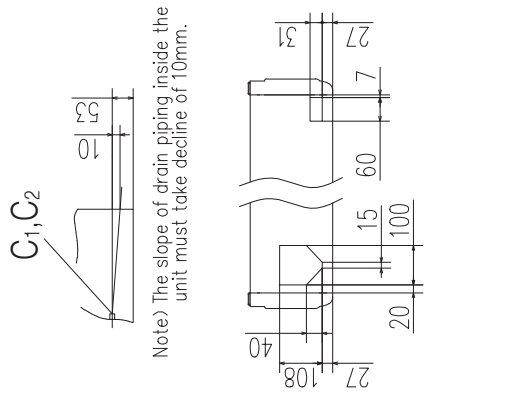

Note (1) The model name label is attached on the fan casing inside the air return grille.

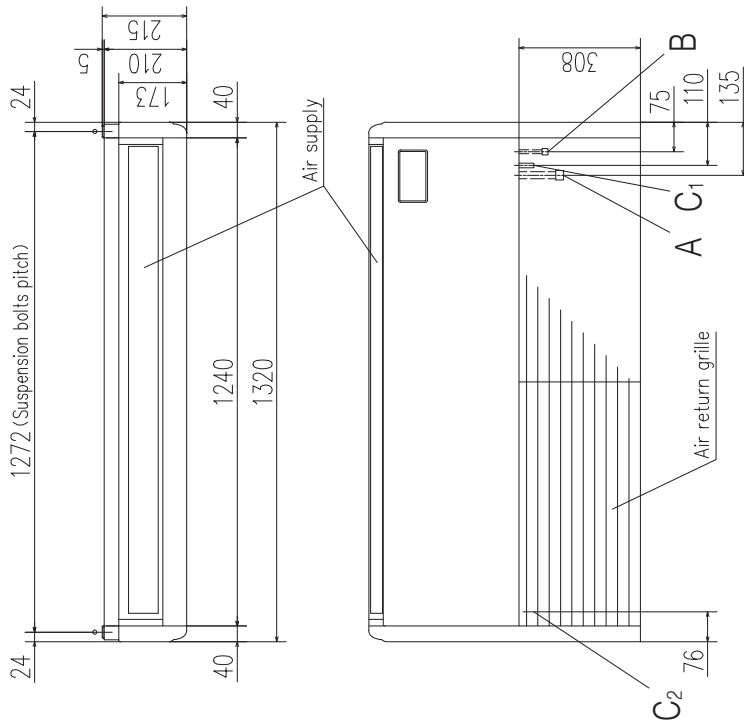

Symbol	Model	Content
A	Gas piping	FDE71
B	Liquid piping	φ15.88 (5/8") (Flare)
C 1,2	Drain piping	φ9.52 (3/8") (Flare)
D	Hole for suspension bolts	VP20
E	Back cutout	(M10 or M8)
F	Top cutout	PE cover
G	Hole for drain piping (for left back)	Plate cover (Knock out)

Unit: mm

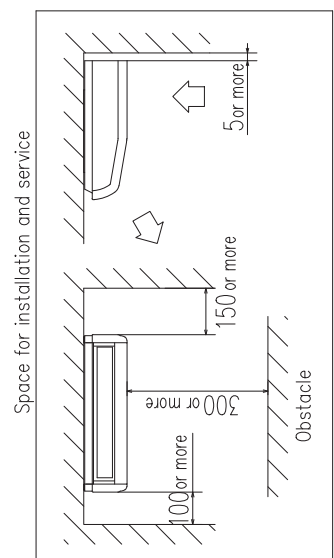
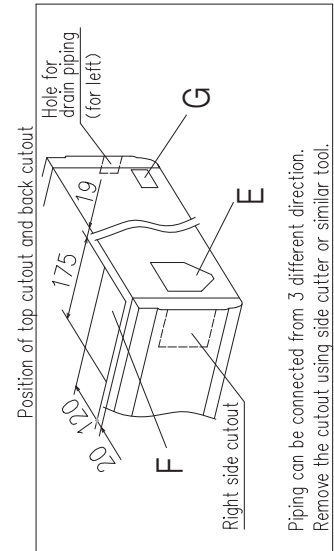

PFA004Z085

(f) Wall mounted type (SRK)
Model SRK71ZR-W

Symbol	Content
A	Gas piping φ 15.88 (5/8") (Flare)
B	Liquid piping φ 6.35 (1/4") (Flare)
C	Hole on wall for right rear piping (φ 65)
D	Hole on wall for left rear piping (φ 65)
E	Drain hose VP16
F	Outlet for wiring (on both side)
G	Outlet for piping (on both side)

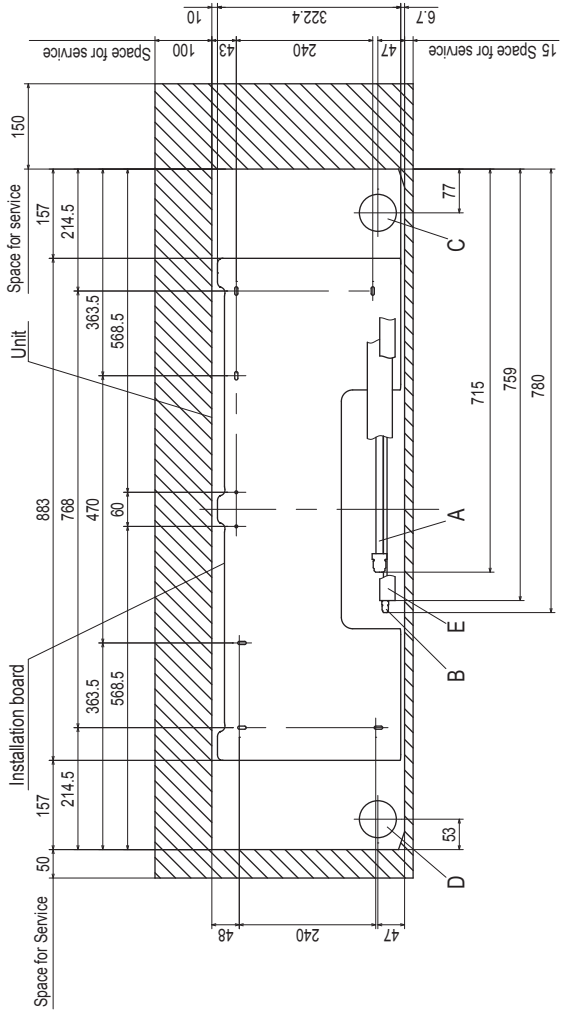
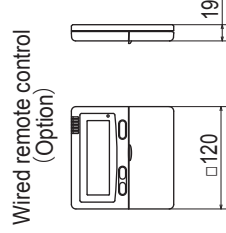
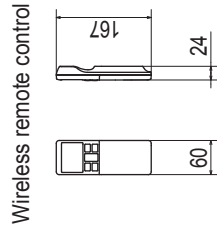
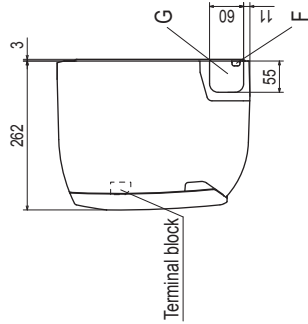
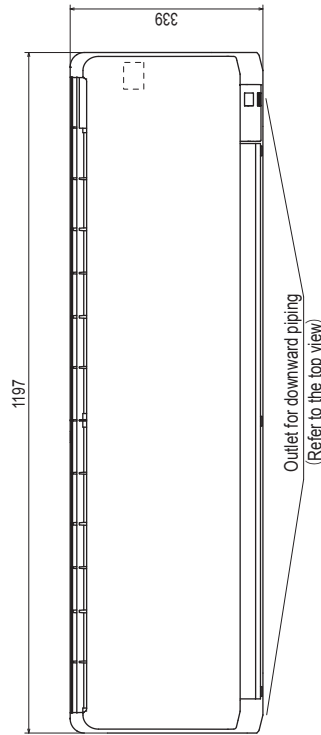
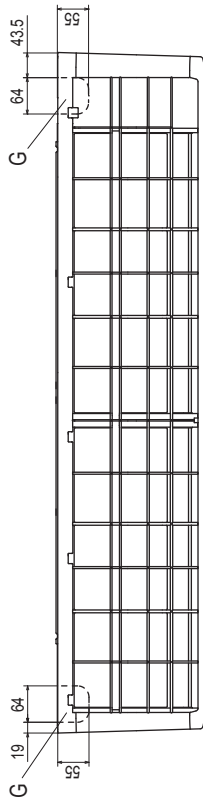

Space for installation and service when viewing from the front

Notes (1) The model name label is attached on the underside of the indoor unit.
 (2) To connect the wired remote control, the interface kit (SC-BIKN2-E) is required.

Unit:mm

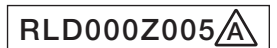

(2) Outdoor unit

Model FDC71VNX-W

Notes

- (1) It must not be surrounded by walls on the four sides.
- (2) The unit must be fixed with anchor bolts. An anchor bolt must not protrude more than 15mm.
- (3) Where the unit is subject to strong winds, lay it in such a direction that the blower outlet faces perpendicularly to the dominant wind direction.
- (4) Leave 1m or more space above the unit.
- (5) A wall in front of the blower outlet must not exceed the units height.
- (6) The model name label is attached on the lower right corner of the front.

Symbol	Content
A	Service valve connection (gas side) φ 15.88 (5/8") (Flare)
B	Service valve connection (liquid side) φ 9.52 (3/8") (Flare)
C	Pipe/cable draw-out hole
D	Drain discharge hole φ 20×4 places
E	Anchor bolt hole M10×4 places

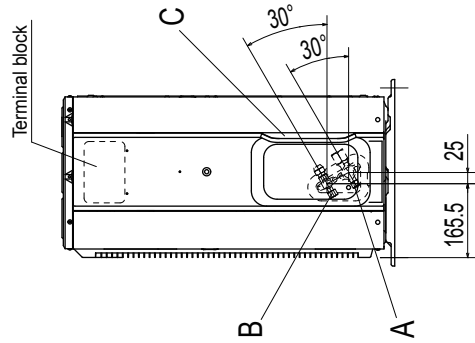
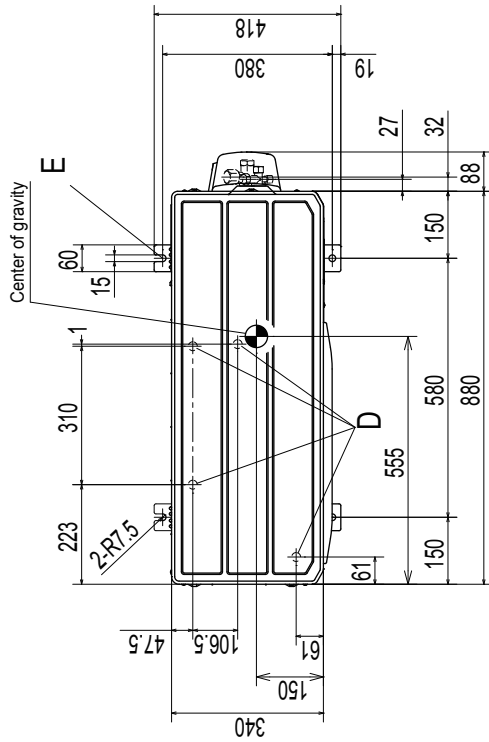

Minimum installation space

Examples of installation Dimensions	I		II		III	
	L1	Open	Open	Open	500	Open
L2	300	250	250	150	100	100
L3	100	250	250	250	250	250
L4	250	250	250	250	250	250

Unit:mm

PCA001Z879

(3) Remote control (Option parts)

(a) Wired remote control

Model RC-EX3A

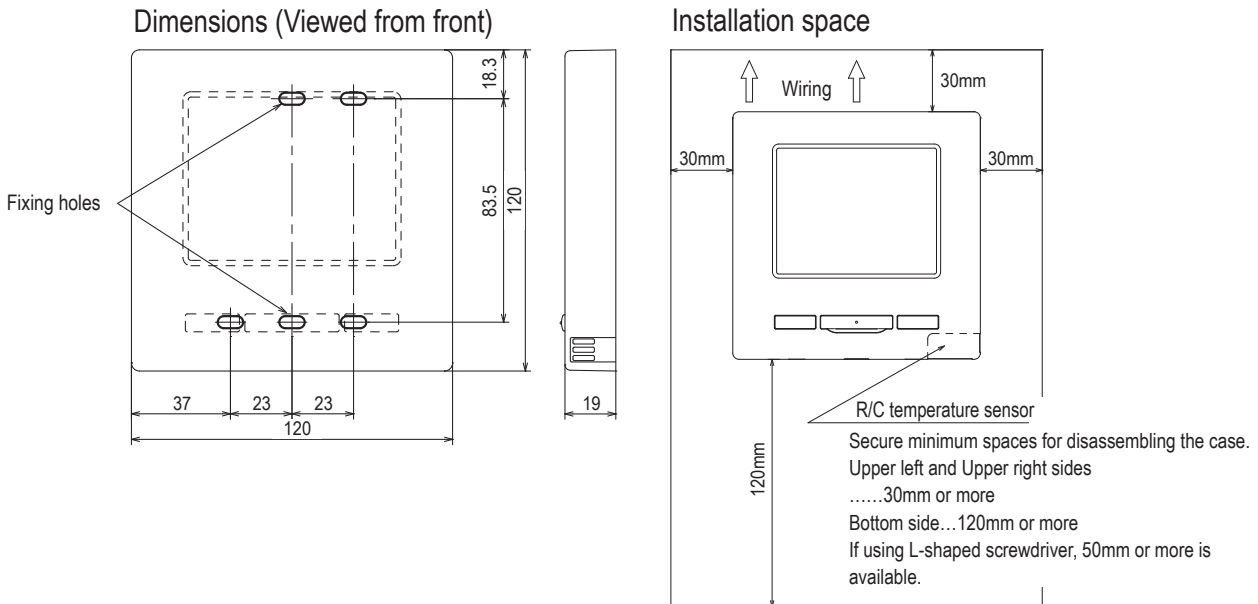

• Do not install the remote control at following places.

- 1) It could cause break-down or deformation of remote control.
 - Where it is exposed to direct sunlight
 - Where the ambient temperature becomes 0 °C or below, or 40 °C or above
 - Where the surface is not flat
 - Where the strength of installation area is insufficient
- 2) Moisture may be attached to internal parts of the remote control, resulting in a display failure.
 - Place with high humidity where condensation occurs on the remote control
 - Where the remote control gets wet
- 3) Accurate room temperature may not be detected using the temperature sensor of the remote control.
 - Where the average room temperature cannot be detected
 - Place near the equipment to generate heat
 - Place affected by outside air in opening/closing the door
 - Place exposed to direct sunlight or wind from air-conditioner
 - Where the difference between wall and room temperature is large
- 4) When you are using the automatic grille up and down panel in the IU, you may not be able to confirm the up and down motion.
 - Where the IU cannot be visually confirmed

R/C cable:0.3mm²x2 cores

When the cable length is longer than 100 m, the max size for wires used in the R/C case is 0.5 mm². Connect them to wires of larger size near the outside of R/C. When wires are connected, take measures to prevent water, etc. from entering inside.

≦ 200 m	0.5 mm ² x 2 cores
≦ 300m	0.75 mm ² x 2 cores
≦ 400m	1.25 mm ² x 2 cores
≦ 600m	2.0 mm ² x 2 cores

• When installing the unit at a hospital, telecommunication facility, etc., take measures to suppress electric noises.

It could cause malfunction or break-down due to hazardous effects on the inverter, private power generator, high frequency medical equipment, radio communication equipment, etc.

The influences transmitted from the remote control to medical or communication equipment could disrupt medical activities, video broadcasting or cause noise interference.

Adapted RoHS directive

PJZ000Z333

Model RC-E5

Exposed mounting

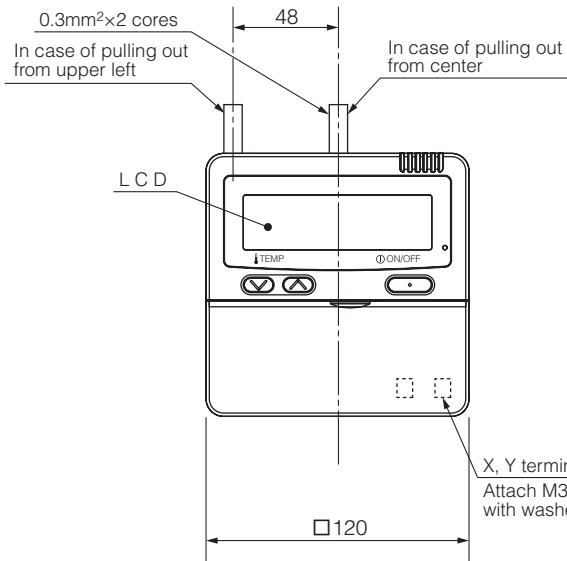

Exterior appearance (Munsell color)	Pearl white (N8.5) near equivalent
-------------------------------------	------------------------------------

Wiring outlet

Cut off the upper thin part of remote control lower case with a nipper or knife, and grind burrs with a file etc.

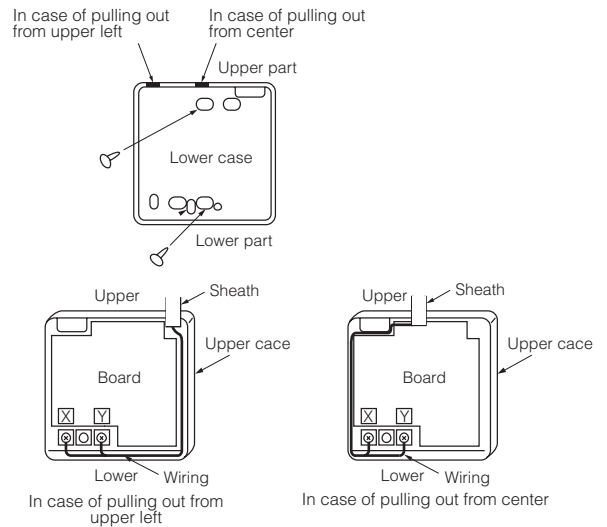

The peeling-off length of sheath	
Pulling out from upper left	Pulling out from center
X wiring : 215mm	X wiring : 170mm
Y wiring : 195mm	Y wiring : 190mm

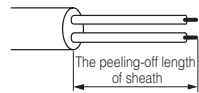

Embedded mounting

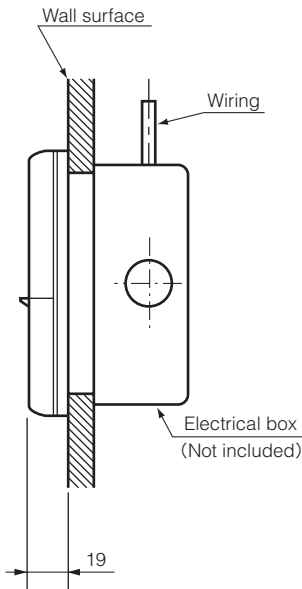

Remote control installation dimensions

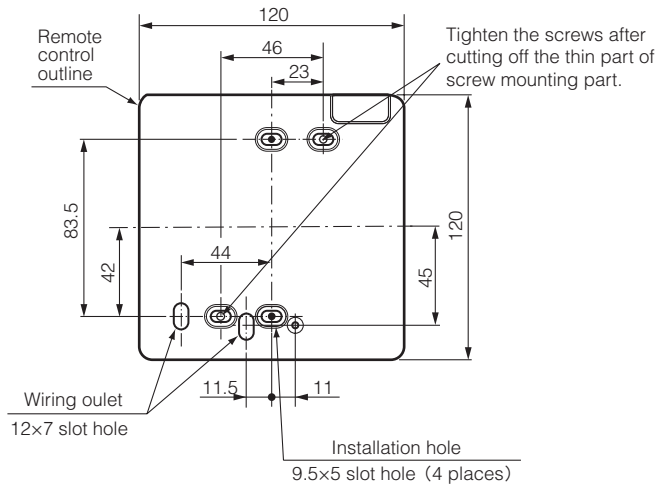

- 1) Installation screw for remote control
M4 screw (2 pieces)

Unit:mm

Wiring specifications

1) If the prolongation is over 100m, change to the size below.
But, wiring in the remote control case should be under 0.5mm². Change the wire size outside of the case according to wire connecting. Waterproof treatment is necessary at the wire connecting section. Be careful about contact failure.

Length	Wiring thickness
100 to 200m	0.5mm ² x2 cores
Under 300m	0.75mm ² x2 cores
Under 400m	1.25mm ² x2 cores
Under 600m	2.0mm ² x2 cores

PJZ000Z295

(b) Wireless remote control

RCN-E2(Option parts) (Except SRK series)

Unit: mm

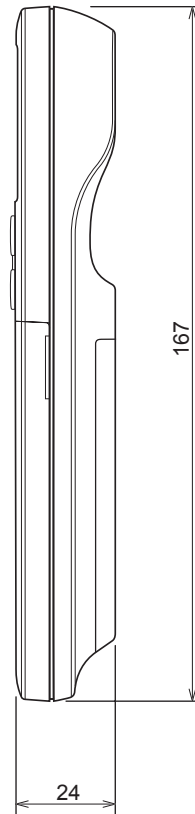
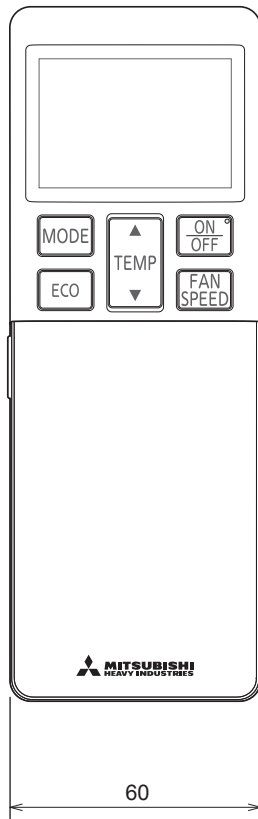

SRK series only

Unit: mm

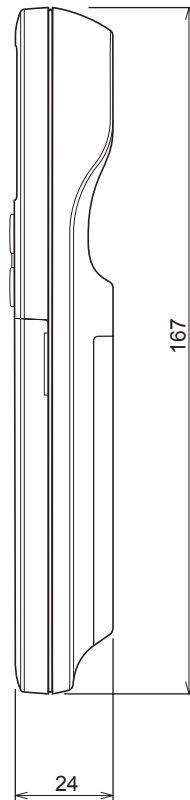
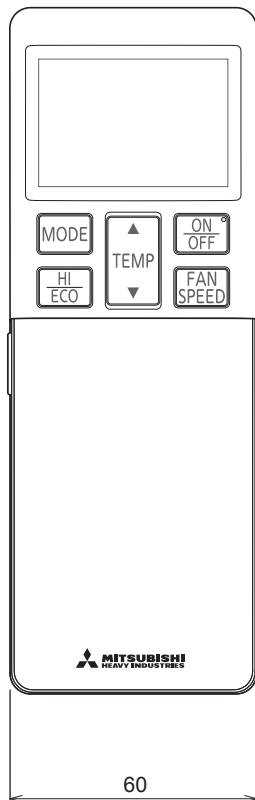

1.3 ELECTRICAL WIRING

(1) Indoor units

(a) Ceiling cassette-4 way type (FDT)

Models FDT40VH, 71VH

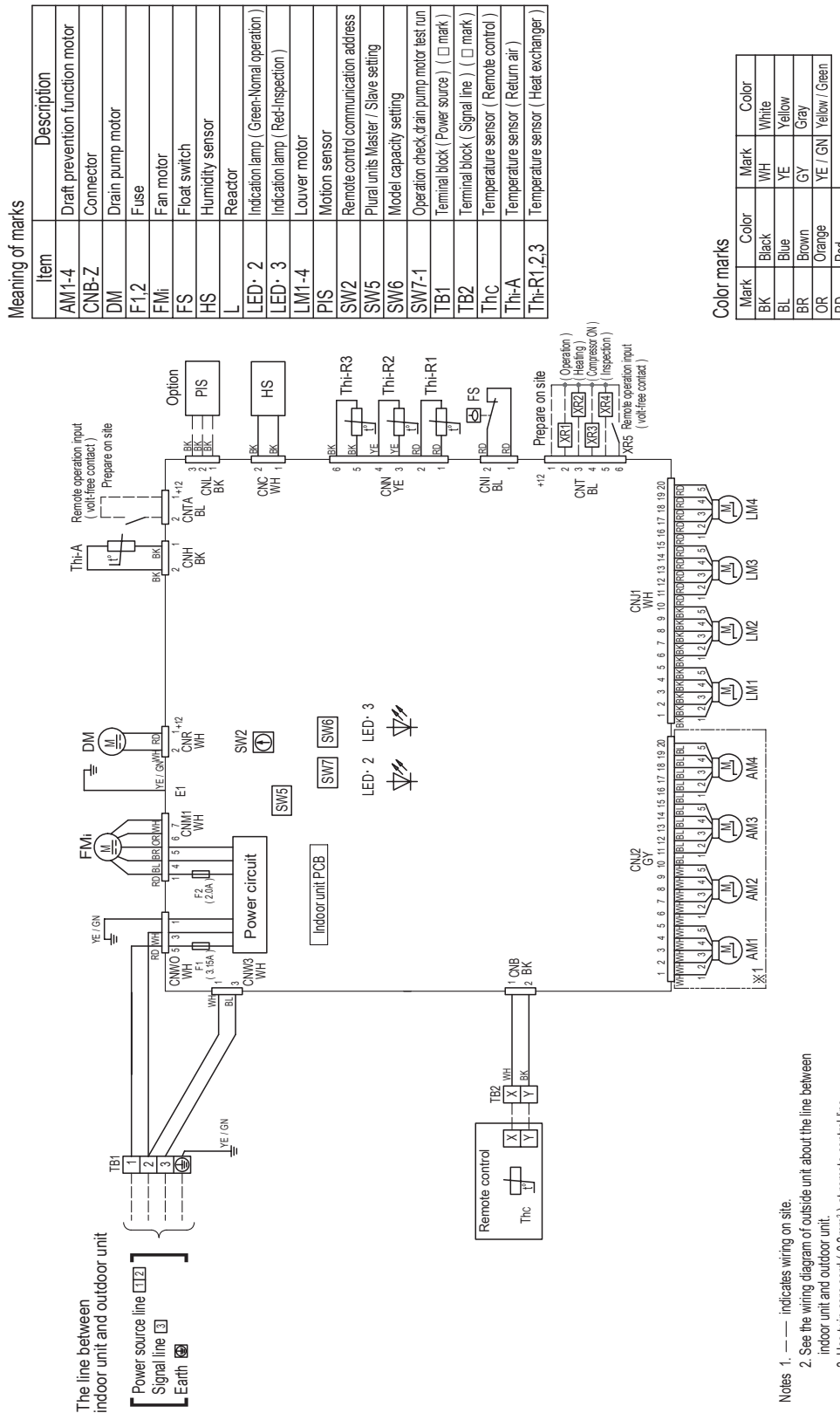

- Notes
1. — indicates wiring on site.
 2. See the wiring diagram of outside unit about the line between indoor unit and outdoor unit.
 3. Use twin core cord (0.3mm²) at remote control line.
 4. See spec. sheet of remote control in case that the total length is more than 100m.
 5. Do not put remote control line alongside power source line.
 6. Section 1 (※1) is provided on the panel T-PSAE-SAW-E only.

PJF000Z554

(b) Ceiling cassette-4 way compact type (FDTC)
Model FDTC40VH

Meaning of marks

Item	Description
AM1-4	Draft prevention function motor
CNB-Z	Connector
DM	Drain pump motor
F1,2	Fuse
FMI	Fan motor
FS	Float switch
HS	Humidity sensor
LED-2	Indication lamp (Green-Normal operation)
LED-3	Indication lamp (Red-Inspection)
LM1-4	Lower motor
PIS	Motion sensor
SW2	Remote control communication address
SW5	Plural units Master/ Slave setting
SW6	Model capacity setting
SW7-1	Operation check, drain pump motor test run
TB1	Terminal block (Power source) (□:mark)
TB2	Terminal block (Signal line) (□:mark)
Thc	Temperature sensor (Remote control)
Thi-A	Temperature sensor (Return air)
Thi-R1,2,3	Temperature sensor (Heat exchanger)

Color marks

Mark	Color	Mark	Color
BK	Black	WH	White
BL	Blue	YE	Yellow
BR	Brown	GY	Gray
OR	Orange	YE/GN	Yellow/Green
RD	Red		

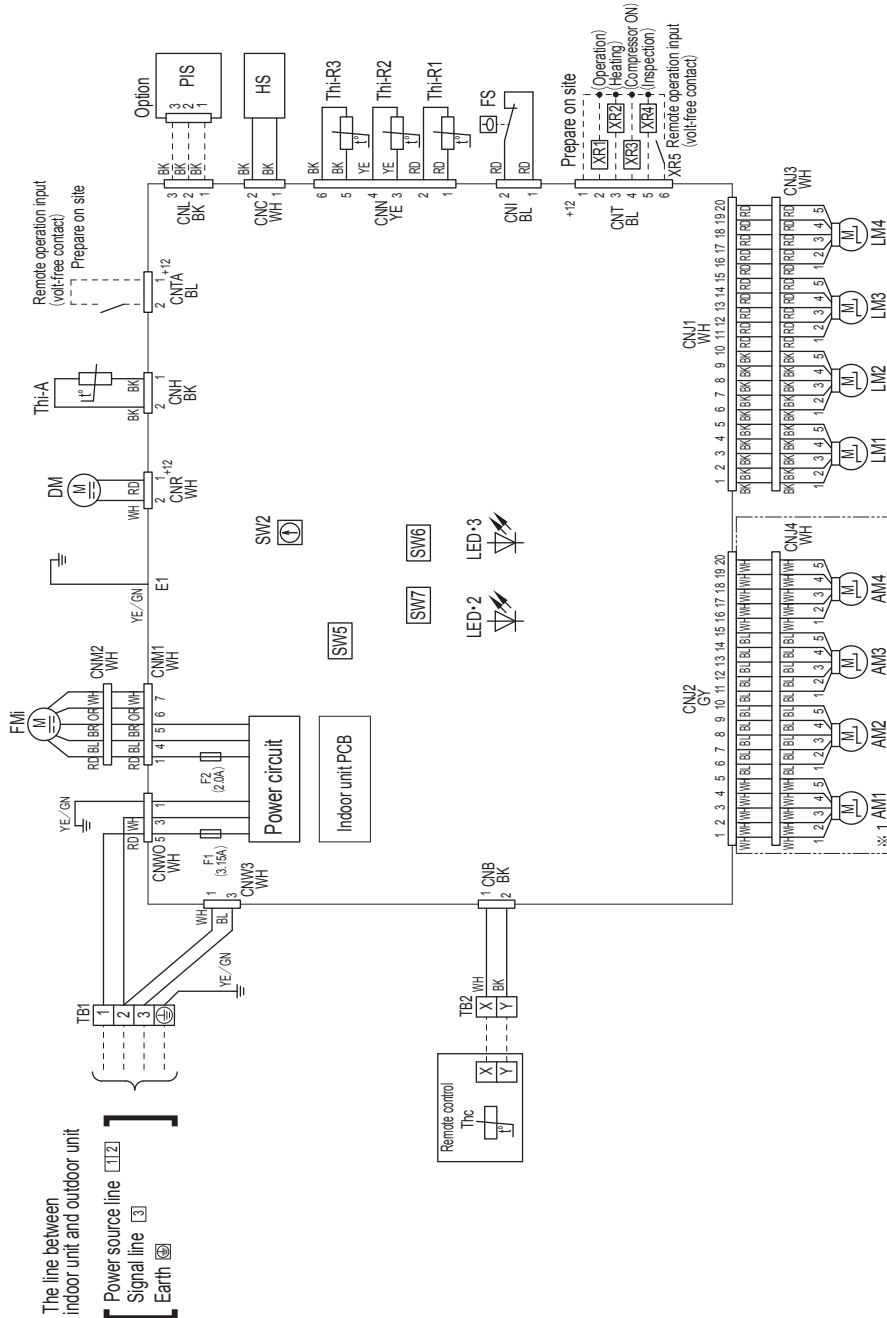

- Notes
1. - - - - indicates wiring on site.
 2. See the wiring diagram of outdoor unit about the line between indoor unit and outdoor unit.
 3. Use twin core cord (0.3mm²) at remote control line.
 4. Do not put remote control line alongside power source line.
 5. Draft prevention function (※ 1) is provided on the panel TC-PSAE-5AW-E only.

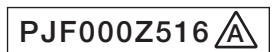

(c) Duct connected-High static pressure type (FDU)

Model FDU71VH

Meaning of marks

Item	Description
CNB-Z	Connector
DM	Drain pump motor
F1,4	Fuse
FM2	Fan motor
FS	Float switch
L	Reactor
LED-2	Indication lamp (Green-Normal operation)
LED-3	Indication lamp (Red-Inspection)
PIS	Motion sensor
SW2	Remote control communication address
SW5	Plural units Master / Slave setting
SW6	Model capacity setting
SW7-1	Operation check, drain pump motor test run
TB1	Terminal block (Power source) (□mark)
TB2	Terminal block (Signal line) (□mark)
Thc	Temperature sensor (Remote control)
Thi-A	Temperature sensor (Return air)
Thi-R1,2,3	Temperature sensor (Heat exchanger)
■mark	Closed-end connector

Color Marks	Mark	Color
	BK	Black
	BL	Blue
	RD	Red
	WH	White
	YE	Yellow
	YE/GN	Yellow / Green

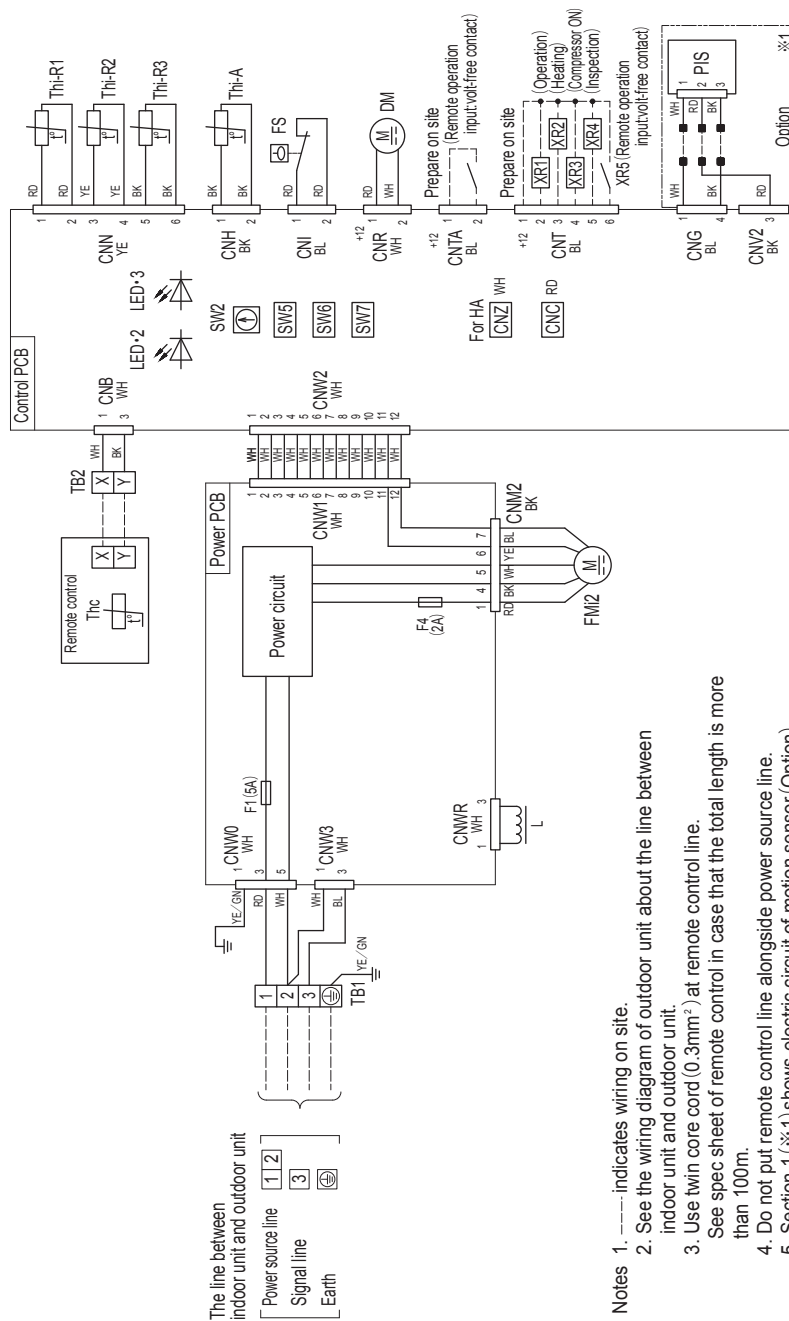

- Notes
1. ----- indicates wiring on site.
 2. See the wiring diagram of outdoor unit about the line between indoor unit and outdoor unit.
 3. Use twin core cord (0.3mm²) at remote control line. See spec sheet of remote control in case that the total length is more than 100m.
 4. Do not put remote control line alongside power source line.
 5. Section 1 (※1) shows electric circuit of motion sensor (Option).

PJG000Z578

(d) Duct connected-Low / Middle static pressure type (FDUM)

Model FDUM40VH

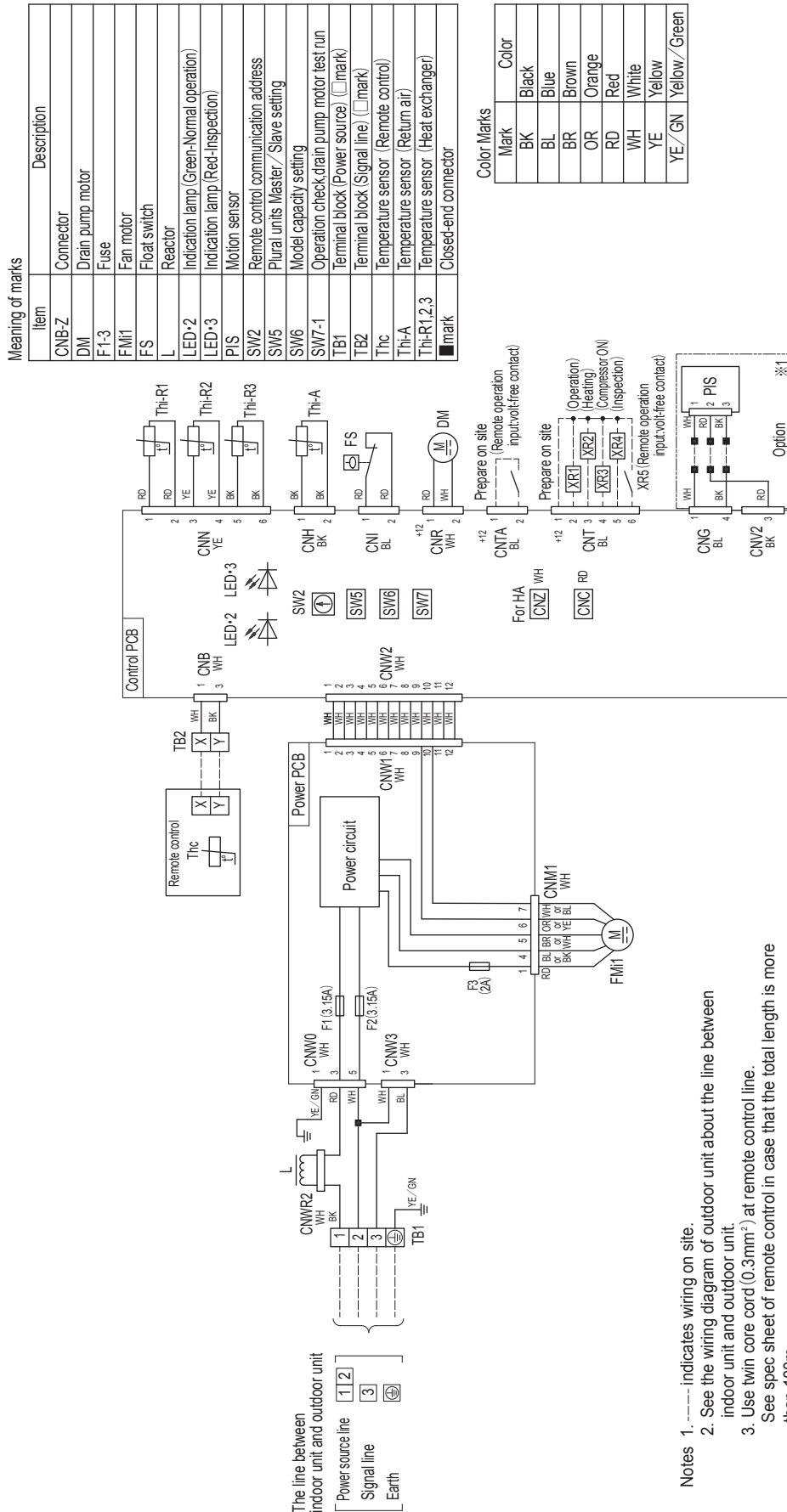

Meaning of marks

Item	Description
CNB-Z	Connector
DM	Drain pump motor
F1-3	Fuse
FMI1	Fan motor
FS	Float switch
L	Reactor
LED-2	Indication lamp (Green-Normal operation)
LED-3	Indication lamp (Red-Inspection)
PIS	Motion sensor
SW2	Remote control communication address
SW5	Plural units Master/ Slave setting
SW6	Model capacity setting
SW7-1	Operation check drain pump motor test run
TB1	Terminal block (Power source) (□mark)
TB2	Terminal block (Signal line) (□mark)
Thc	Temperature sensor (Remote control)
Th-A	Temperature sensor (Return air)
Th-R1,2,3	Temperature sensor (Heat exchanger)
■mark	Closed-end connector

Color Marks

Mark	Color
BK	Black
BL	Blue
BR	Brown
OR	Orange
RD	Red
WH	White
YE	Yellow
YE/GN	Yellow/Green

- Notes
1. --- indicates wiring on site.
 2. See the wiring diagram of outdoor unit about the line between indoor unit and outdoor unit.
 3. Use twin core cord (0.3mm²) at remote control line.
See spec sheet of remote control in case that the total length is more than 100m.
 4. Do not put remote control line alongside power source line.
 5. Section 1 (※1) shows electric circuit of motion sensor (Option).

PJG000Z488

Model FDUM71VH

Meaning of marks

Item	Description
CNB-Z	Connector
DM	Drain pump motor
F1.4	Fuse
FM2	Fan motor
FS	Float switch
LED-2	Indication lamp (Green-Normal operation)
LED-3	Indication lamp (Red-Inspection)
PIS	Motion sensor
SW2	Remote control communication address
SW5	Plural units Master / Slave setting
SW6	Model capacity setting
SW7-1	Operation check, drain pump motor test run
TB1	Terminal block (Power source) (□mark)
TB2	Terminal block (Signal line) (□mark)
Thc	Temperature sensor (Remote control)
Thi-A	Temperature sensor (Return air)
Thi-R1,2,3	Temperature sensor (Heat exchanger)
■mark	Closed-end connector

Color Marks	Mark	Color
	BK	Black
	BL	Blue
	BR	Brown
	OR	Orange
	RD	Red
	WH	White
	YE	Yellow
	YE/GN	Yellow/Green

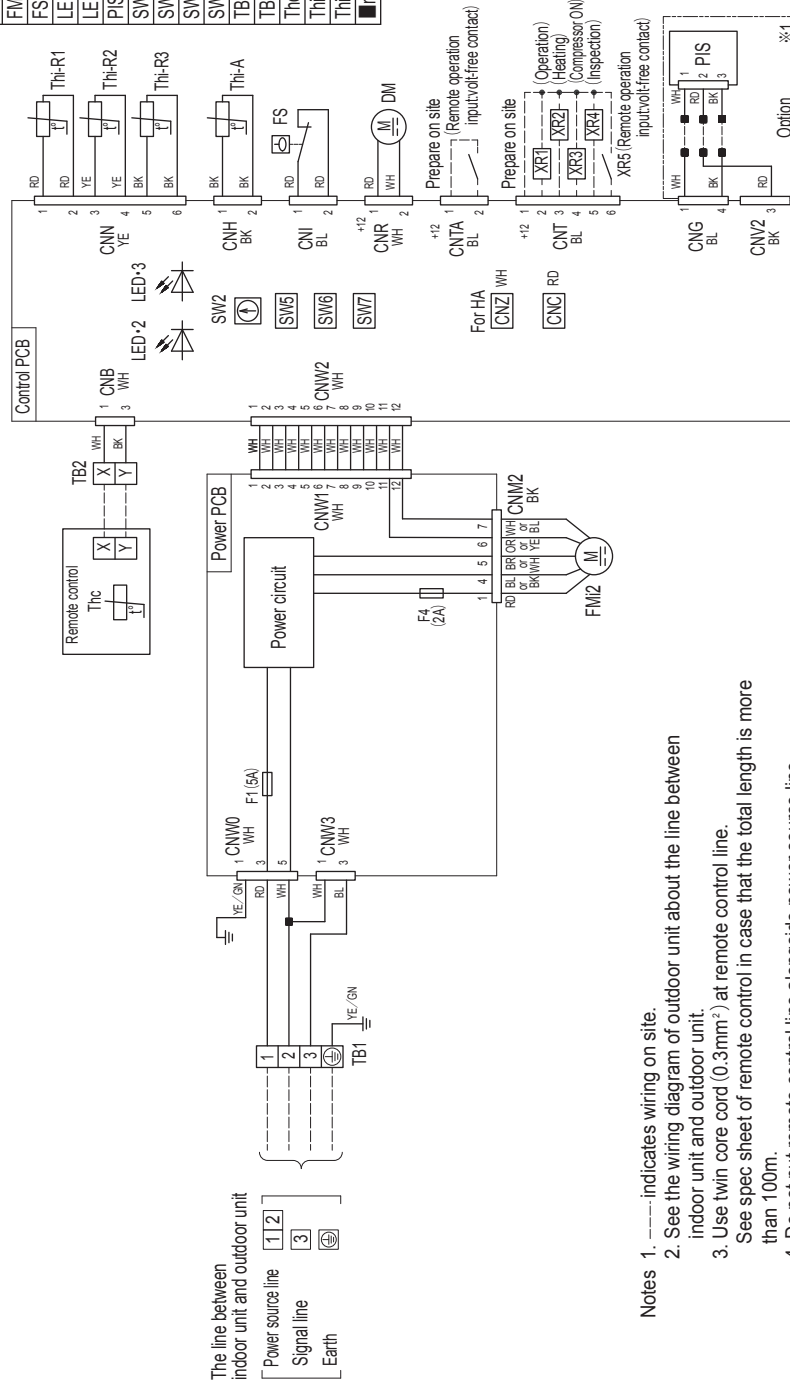

- Notes
1. ----- indicates wiring on site.
 2. See the wiring diagram of outdoor unit about the line between indoor unit and outdoor unit.
 3. Use twin core cord (0.3mm²) at remote control line. See spec sheet of remote control in case that the total length is more than 100m.
 4. Do not put remote control line alongside power source line.
 5. Section 1 (※1) shows electric circuit of motion sensor (Option).

PJG000Z489

(e) Ceiling suspended type (FDE)
Models FDE40VH, 71VH

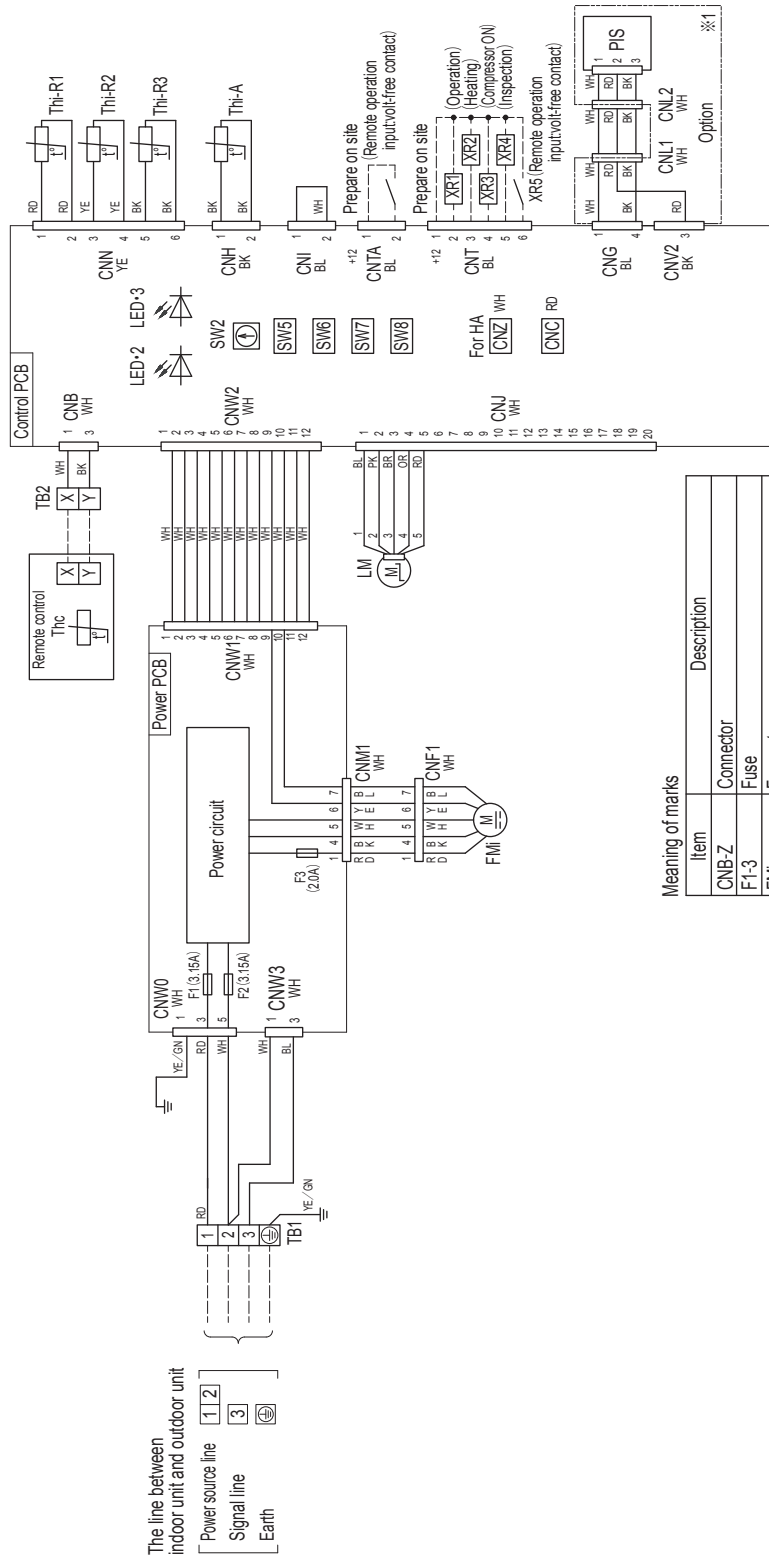

Color marks

Mark	Color
BK	Black
BL	Blue
BR	Brown
OR	Orange
PK	Pink
RD	Red
WH	White
YE	Yellow
YE/GN	Yellow/Green

Meaning of marks

Item	Description
CNB-Z	Connector
F1-3	Fuse
FMi	Fan motor
L	Reactor
LED-2	Indication lamp (Green-Normal operation)
LED-3	Indication lamp (Red-Inspection)
LM	Louver motor
PIS	Motion sensor
SW2	Remote control communication address
SW5	Plural units Master/Slave setting
SW6	Model capacity setting
SW7-1	Operation check drain pump motor test run
SW8-1	Anti-freeze control
TB1	Terminal block (Power source) (□mark)
TB2	Terminal block (Signal line) (□mark)
Thc	Temperature sensor (Remote control)
Thi-A	Temperature sensor (Return air)
Thi-R1,2,3	Temperature sensor (Heat exchanger)

- Notes
1. ---- indicates wiring on site.
 2. See the wiring diagram of outdoor unit about the line between indoor unit and outdoor unit.
 3. Use twin core cord (0.3mm²) at remote control line.
See spec sheet of remote control in case that the total length is more than 100m.
 4. Do not put remote control line alongside power source line.
 5. Section 1 (※1) shows electric circuit of motion sensor (Option).

PFA004Z087

(f) Wall mounted type (SRK)

Model SRK71ZR-W

Item	Description
CNE	Connector
CNF	
CNG	
CNM	
CNS	
CNU	
CNX	
CNY	
FMi	Fan motor
SM ₁	Flap motor
LM _{1,2}	Louver motor
Th1	Room temperature sensor
Th2 _{1,2}	Heat exchanger temperature sensor
Th3	Humidity sensor
DS	Diode stack
F	Fuse
TB	Terminal block
Va	Varistor

Color Marks	Mark	Color
	BK	Black
	BL	Blue
	RD	Red
	WH	White
	Y	Yellow
	Y/G	Yellow/Green

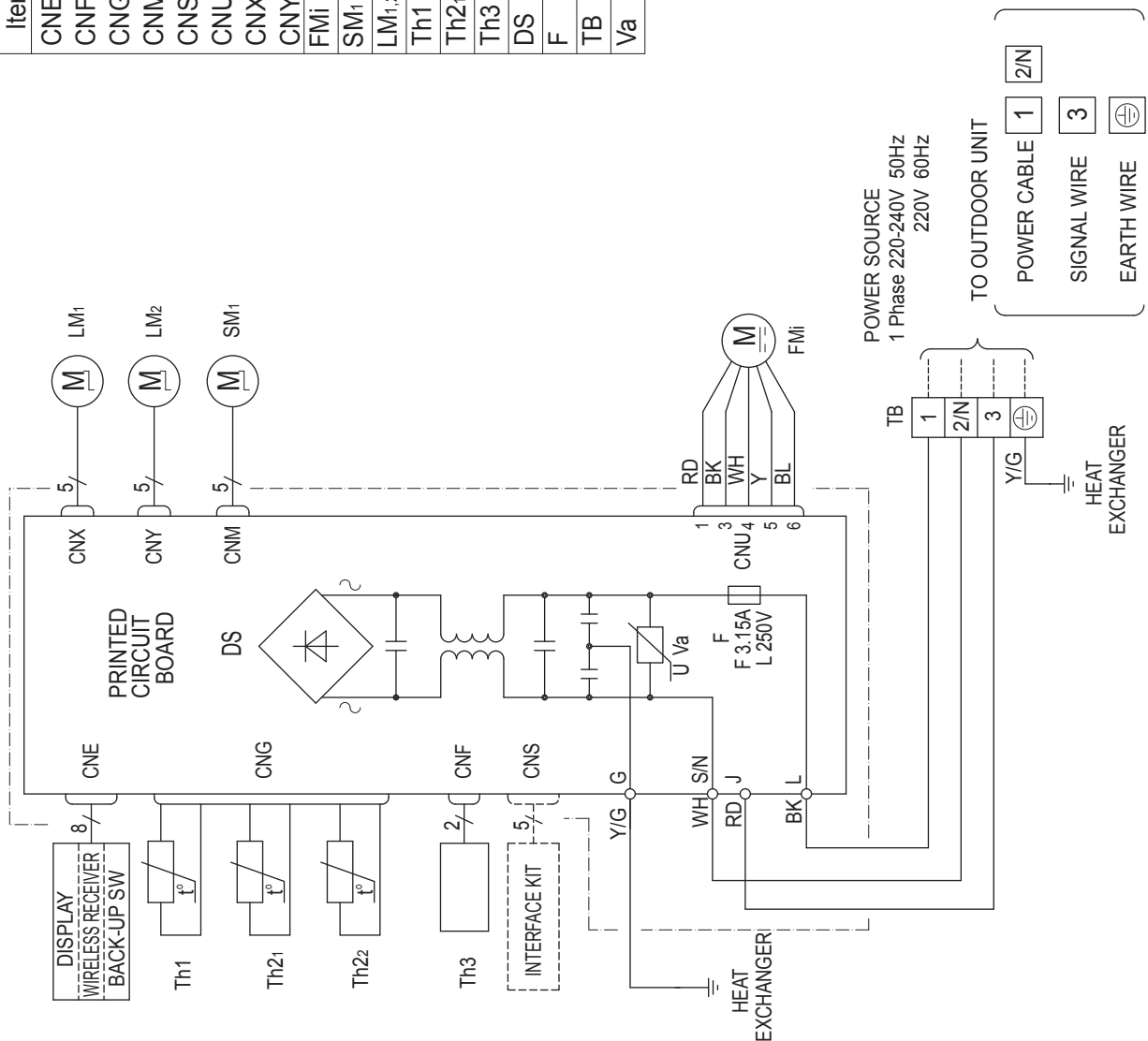

RWA000Z417A

(2) Outdoor unit
Model FDC71VNX-W

Meaning of marks

Item	Description
CM	Compressor motor
CM1	Indoor
CM2	Outdoor
CM3	Compressor heater
CM4	Auxiliary relay (for CH)
CM5	Auxiliary relay (for Z/S)
CM6	Expansion valve (for 4-way valve)
CM7	Expansion valve (for cooling)
CM8	Expansion valve (for heating)
CM9	High pressure switch
CM10	Temperature sensor (Outdoor air)
CM11	Temperature sensor (Discharge pipe)
CM12	Temperature sensor (Heat exchanger)
CM13	Temperature sensor (Suction pipe)
CM14	Low pressure sensor
CM15	Intelligent power module
CM16	Terminal block
CM17	Fuse
CM18	Connector
CM19	Pump down switch
CM20	Local setting switch
CM21	LED1
CM22	LED2
CM23	LED3
CM24	Reactor

Color marks

Mark	Color
BK	Black
BL	Blue
BR	Brown
OR	Orange
RD	Red
WH	White
YE	Yellow
YG	Yellow/Green
GY	Gray
PK	Pink

Power source
1 Phase 220-240V 50Hz/220V 60Hz

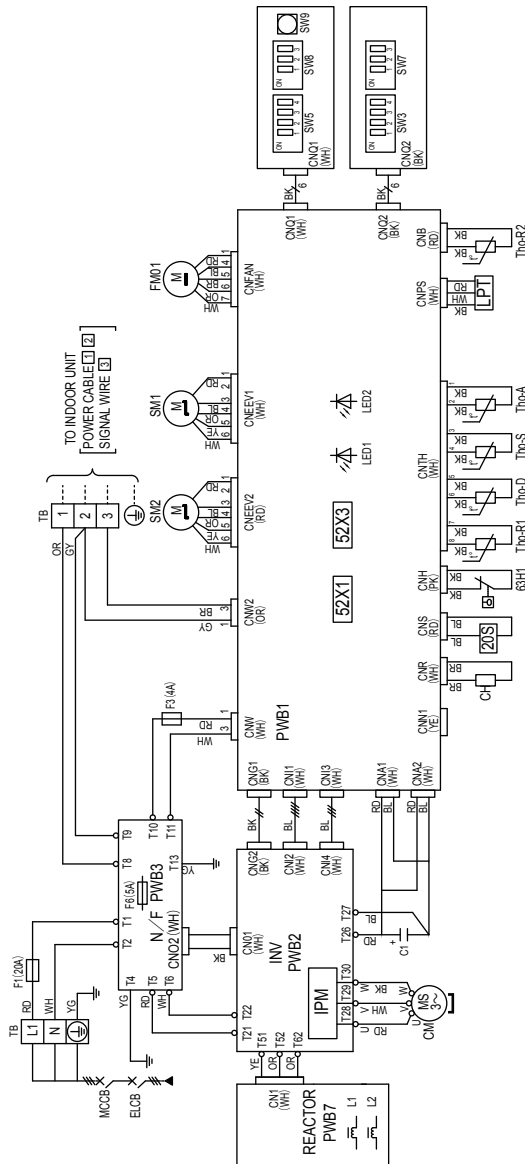

SW3-1	Defrost control change	The defrosting operation interval becomes shorter by turning ON this switch. This switch should be turned ON in the area where outside temperature becomes below the freezing point.
SW3-2	Snow guard fan control	When this switch is turned ON, the outdoor unit fan will run for 10 seconds in every 10 minutes, when outdoor temperature falls to 3°C or lower and the compressor is not running when the unit is used in a very snowy country, set this switch to ON.
SW5-3,4	Trial operation	Method of trial operation 1. Trial operation can be performed by using SW5-3. 2. Cooling trial operation will be performed when SW5-4 is ON and heating trial operation when SW5-4 is OFF. 3. Be sure to turn OFF SW5-3 after the trial operation is finished.

Power cable, indoor-outdoor connecting wires

Model	MAX over current (A)	Power cable size (mm ²)	Power cable length (m)	Indoor-outdoor wire size x number (mm ²)	Earth wire size (mm ²)
71	20	3.5	17	φ 1.6mm x 3	φ 1.6mm

- The specifications shown in the above table are for units without heaters. For units with heaters, refer to the installation instructions or the construction instructions of the indoor unit.
- Switchgear or circuit breaker capacity which is calculated from MAX. over current should be chosen along the regulations in each country.
- The cable specifications are based on the assumption that a metal or plastic conduit is used with no more than three cables contained in a conduit, and a voltage drop is 2%. For an installation falling outside of these conditions, please follow the internal cabling regulations. Adapt it to the regulation in effect in each country.
- Refer to installation manual or technical manual about usage of local setting switch.
- Don't operate SW3-3, SW5-1, SW5-2, SW7, SW8

PCA001Z880

1.4 NOISE LEVEL

Notes(1) The data are based on the following conditions.

Ambient air temperature: Indoor unit 27°CWB, Outdoor unit 35°CDB.

(2) The data in the chart are measured in an anechoic room.

(3) The noise levels measured in the field are usually higher than the data because of reflection.

(1) Indoor units

Measured based on JIS B 8616

(a) Ceiling cassette - 4 way type (FDT)

Mike position

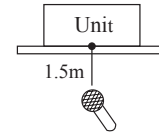

Mike (in front & below unit)

(i) Sound power level

Model FDT40VH

Noise level Cooling : 50 dB (A)
Heating : 50 dB (A)

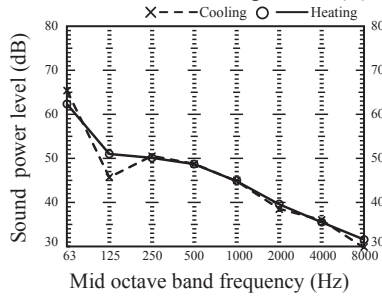

Model FDT71VH

Noise level Cooling : 59 dB (A)
Heating : 60 dB (A)

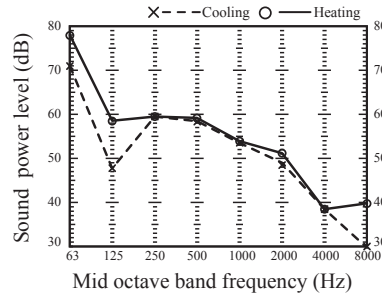

(ii) Sound pressure level

Model FDT40VH

Noise level 36 dB(A) at P-Hi
33 dB(A) at Hi
30 dB(A) at Me
26 dB(A) at Lo

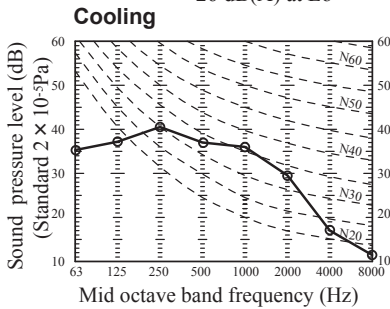

Noise level 36 dB(A) at P-Hi
33 dB(A) at Hi
28 dB(A) at Me
20 dB(A) at Lo

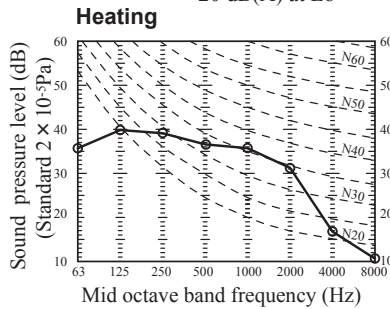

Model FDT71VH

Noise level 46 dB (A) at P-Hi
34 dB (A) at Hi
31 dB (A) at Me
26 dB (A) at Lo

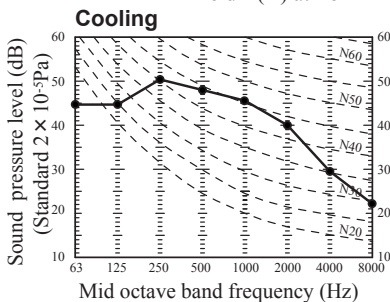

Noise level 46 dB (A) at P-Hi
34 dB (A) at Hi
31 dB (A) at Me
26 dB (A) at Lo

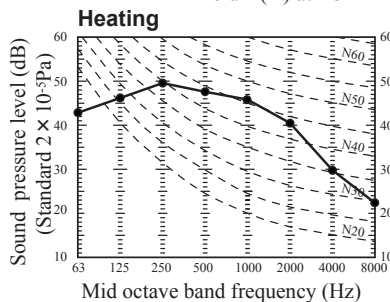

(b) Ceiling cassette-4 way compact type (FDTC)

Measured based on JIS B 8616
Mike position as right



Model FDTC40VH

Noise level 44 dB(A) at P-Hi
40 dB(A) at Hi
35 dB(A) at Me
27 dB(A) at Lo

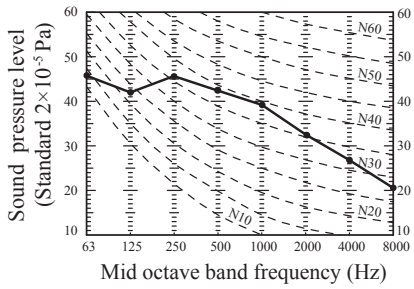

(c) Duct connected-High static pressure type (FDU)

Measured based on JIS B 8616
Mike position as right

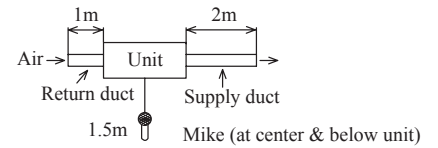

Model FDU71VH

Noise level 38 dB (A) at P-Hi
33 dB (A) at Hi
29 dB (A) at Me
25 dB (A) at Lo

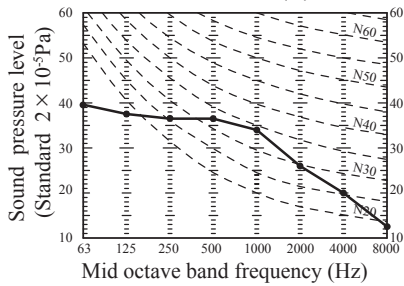

(d) Duct connected-Low/Middle static pressure type (FDUM)

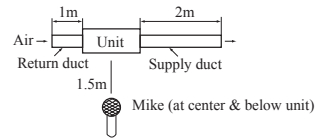

Measured based on JIS B 8616
Mike position as right

Model FDUM40VH

Noise level 37 dB(A) at P-Hi
32 dB(A) at Hi
29 dB(A) at Me
26 dB(A) at Lo

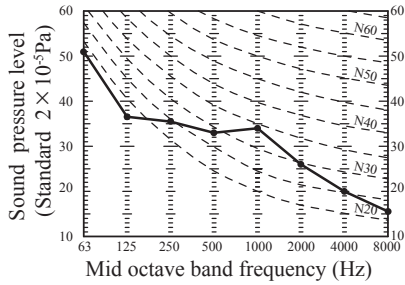

Model FDUM71VH

Noise level 38 dB(A) at P-Hi
33 dB(A) at Hi
29 dB(A) at Me
25 dB(A) at Lo

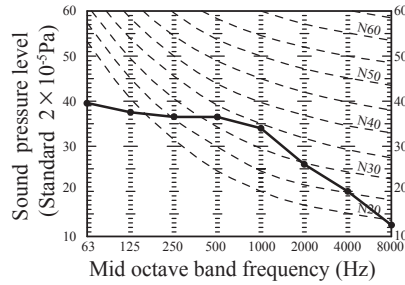

(e) Ceiling suspended type (FDE)

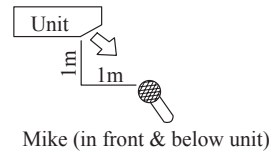

Measured based on JIS B 8616
Mike position as right

Model FDE40VH

Noise level 46 dB(A) at P-Hi
38 dB(A) at Hi
36 dB(A) at Me
31 dB(A) at Lo

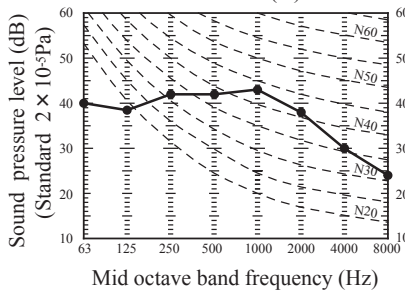

Model FDE71VH

Noise level 47 dB(A) at P-Hi
41 dB(A) at Hi
37 dB(A) at Me
32 dB(A) at Lo

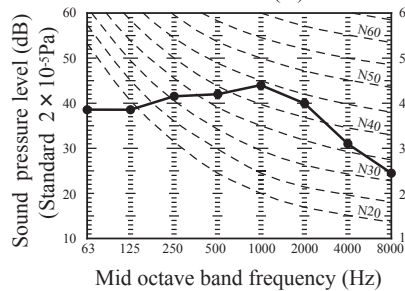

(f) Wall mounted type (SRK)

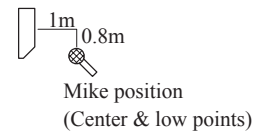

Measured based on JIS C 9612
Mike position as right

Model SRK71ZR-W

Cooling noise level Hi : 44 dB (A)
Heating noise level Hi : 46 dB (A)

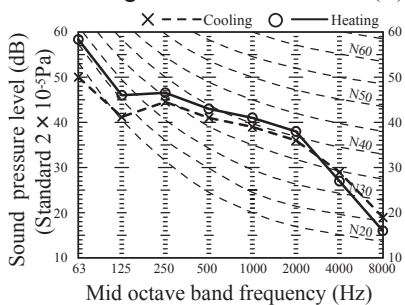

(2) Outdoor unit

Measured based on JIS B 8616

Mike position: at highest noise level in position as mentioned below

Distance from front side 1m

Height 1m

Model FDC71VNX-W

(a) Sound power level

Cooling noise level 66 dB (A)
Heating noise level 66 dB (A)

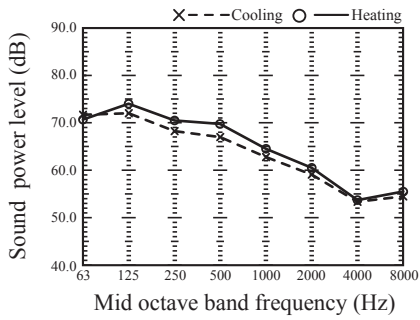

(b) Sound pressure level

(i) Rating mode

Cooling noise level 51 dB (A)
Heating noise level 51 dB (A)

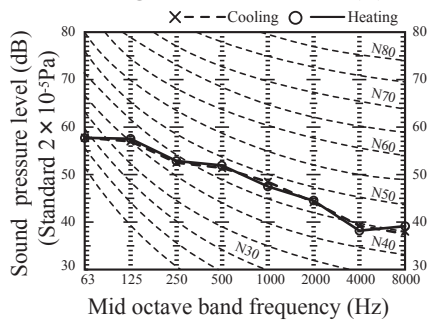

1.5 CHARACTERISTICS OF FAN

(1) Duct connected-High static pressure type (FDU)

- Characteristic FAN (1) shows air flow vs. External Static Pressure (E.S.P.) range where settings of E.S.P. are maximum E.S.P. (SW8-4 OFF : 150Pa, SW8-4 ON : 200Pa), rated E.S.P., and minimum E.S.P. (SW8-4 OFF : 80Pa, SW8-4 ON : 10Pa)
- Characteristic FAN (2) shows air flow vs. E.S.P. curve when set fan tap is set P-Hi with each setting of E.S.P. by remote control.
- External Static Pressure (E.S.P.) can be set by wired remote control.
- You can set required E.S.P. by wired remote control which calculate it with the set air flow rate and pressure loss of the duct connected.

Model FDU71VH

■ SW8-4 : OFF (Range of use limitation : Setting 80Pa-150Pa)

Characteristic FAN (1)

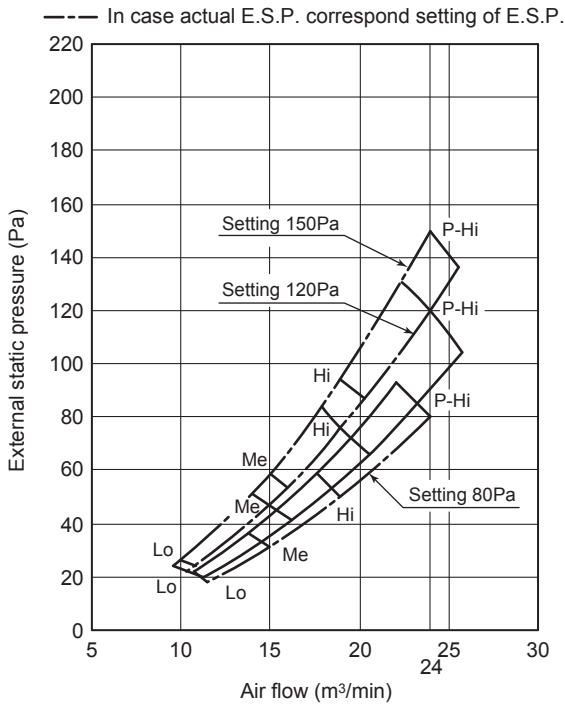

Characteristic FAN (2)

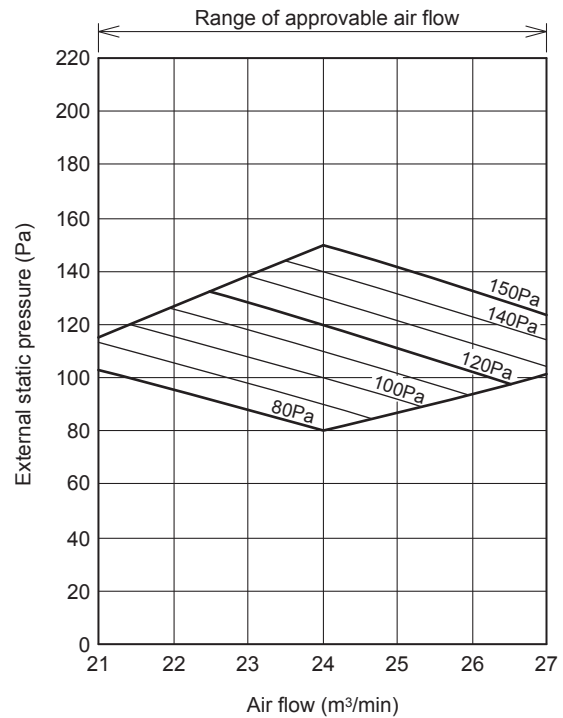

■ SW8-4 : ON (Range of use limitation : Setting 10Pa-200Pa)

Characteristic FAN (1)

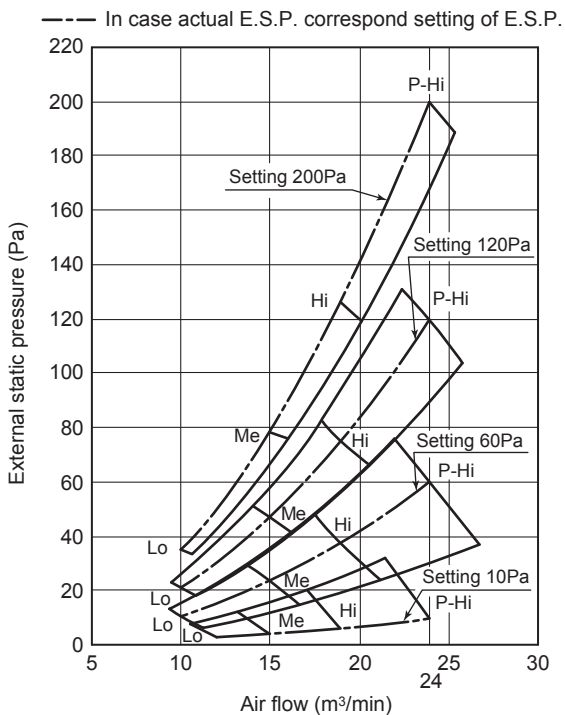

Characteristic FAN (2)

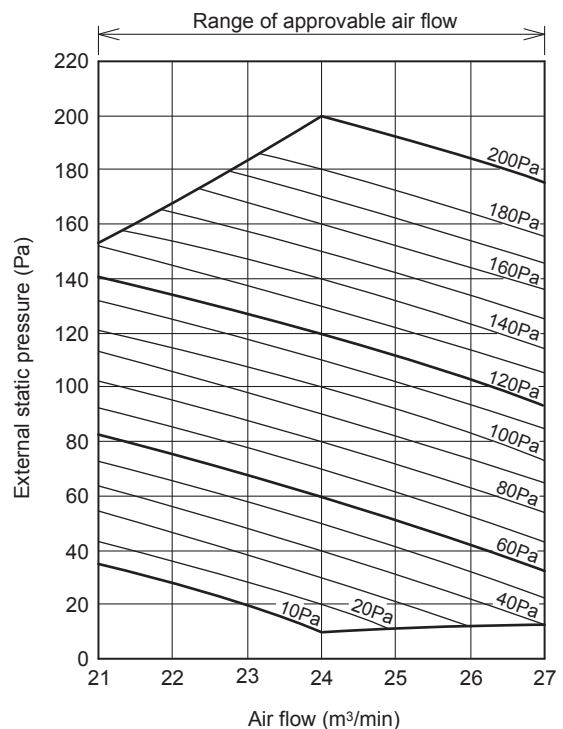

(2) Duct connected-Low / Middle static pressure type (FDUM)

- Characteristic FAN (1) shows air flow vs. External Static Pressure (E.S.P.) range where settings of E.S.P. are maximum E.S.P. (100Pa), rated E.S.P., and minimum E.S.P. (10Pa)
- Characteristic FAN (2) shows air flow vs E.S.P. curve when set fan tap is set P-Hi with each setting of E.S.P. by remote control.
- External Static Pressure (E.S.P.) can be set by wired remote control.
- You can set required E.S.P. by wired remote control which calculate it with the set air flow rate and pressure loss of the duct connected.

Model FDUM40VH

Characteristic FAN(1)

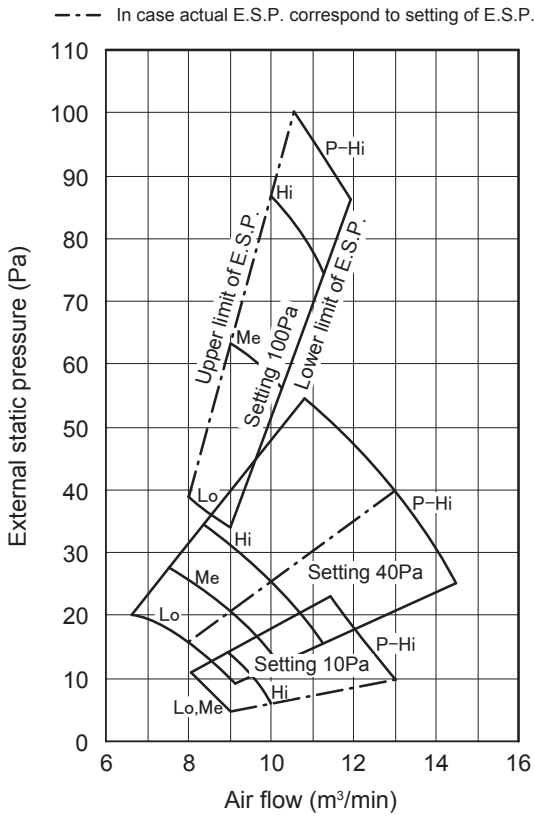

Characteristic FAN(2)

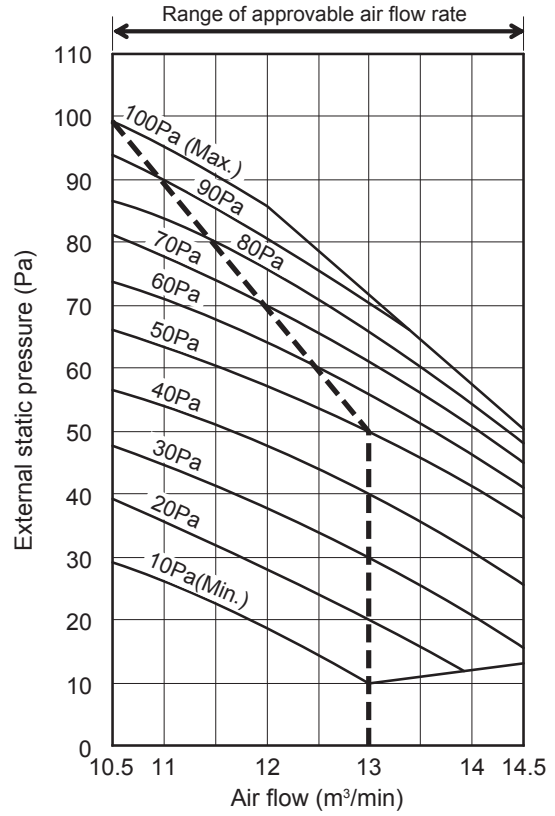

Model FDUM71VH

Characteristic FAN(1)

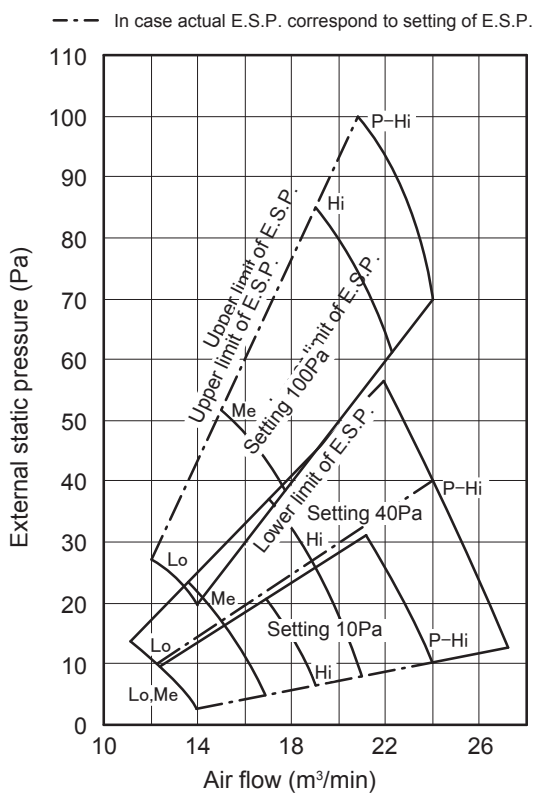

Characteristic FAN(2)

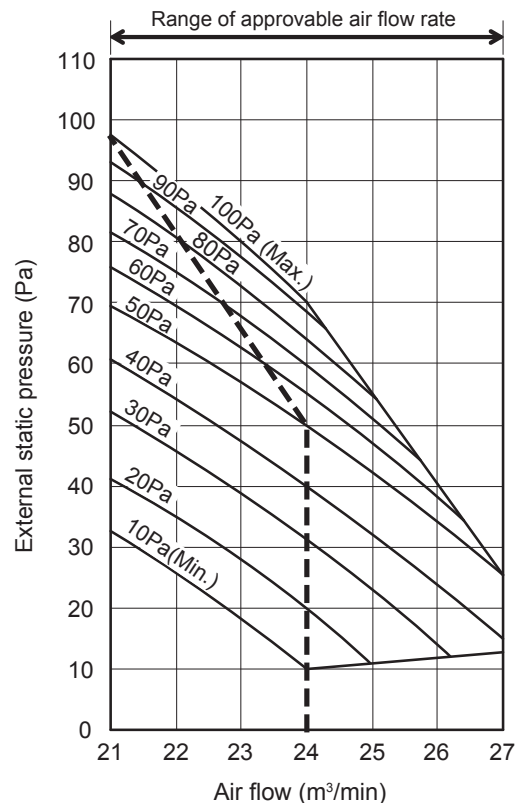

1.6 TEMPERATURE AND VELOCITY DISTRIBUTION

Indoor temperature
 Cooling 27°CDB / 19°CWB
 Heating 20°CDB
 Note: These figures represent the typical main range of temperature and velocity distribution at the center of air outlet within the published conditions.
 In the actual installation, they may differ from the typical figures under the influence of air temperature conditions, ceiling height, operation conditions and obstacles.

(1) Ceiling cassette - 4 way type (FDT)

Model FDT40VH

Cooling Air flow: P-Hi

Louver position

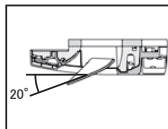

Temperature distribution

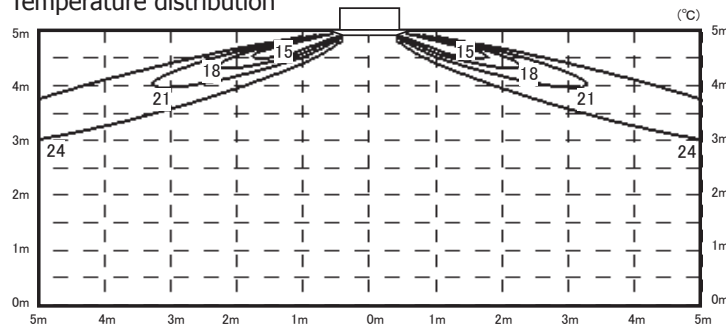

Velocity distribution

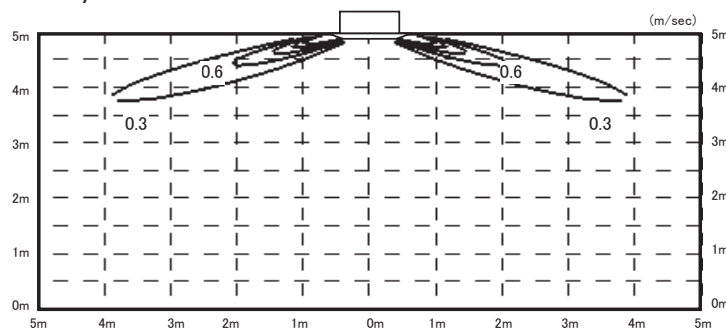

Heating Air flow: P-Hi

Louver position

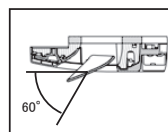

Temperature distribution

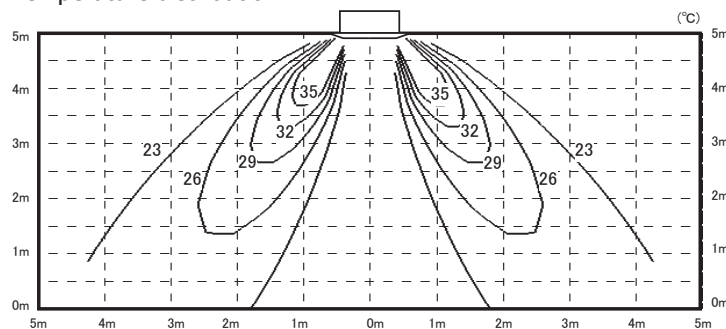

Velocity distribution

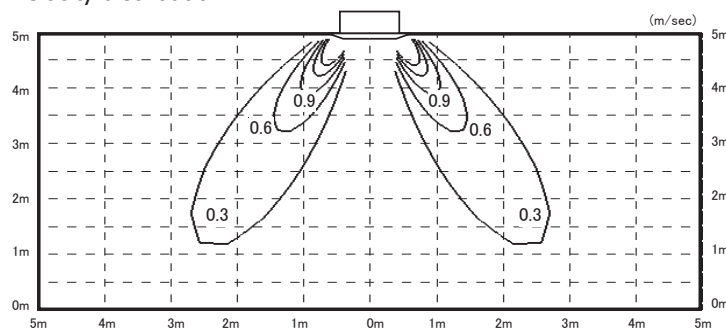

Model FDT71VH

Cooling Air flow: P-Hi Temperature distribution

Louver position

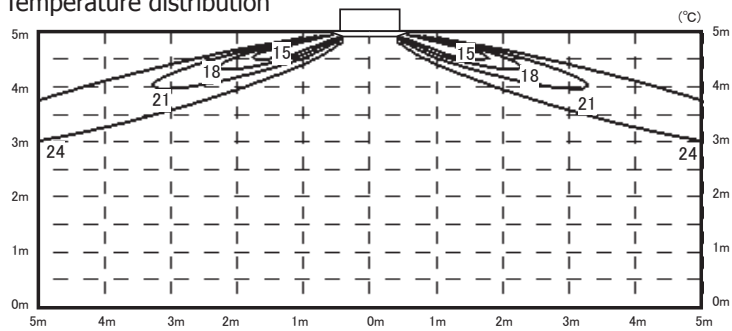
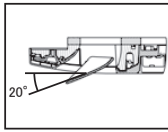

Velocity distribution

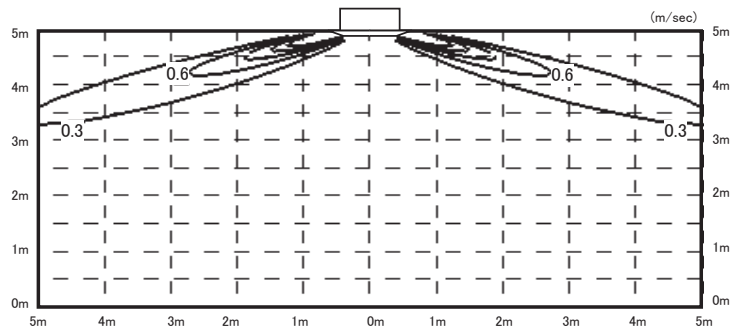

Heating Air flow: P-Hi Temperature distribution

Louver position

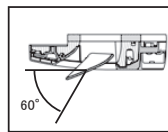

Temperature distribution

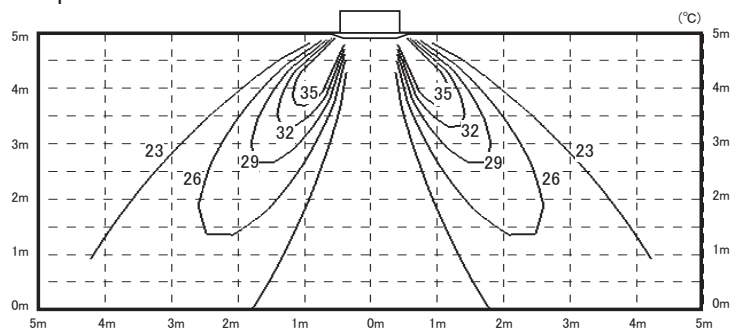

Velocity distribution

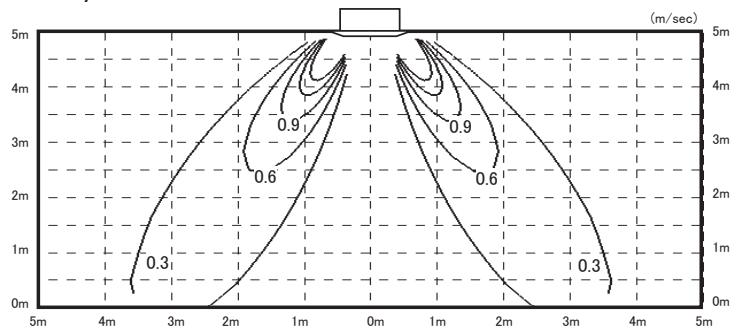

(2) Ceiling cassette-4 way compact type (FDTC)

Model FDTC40VH

Cooling Air flow: P-Hi

Louver position

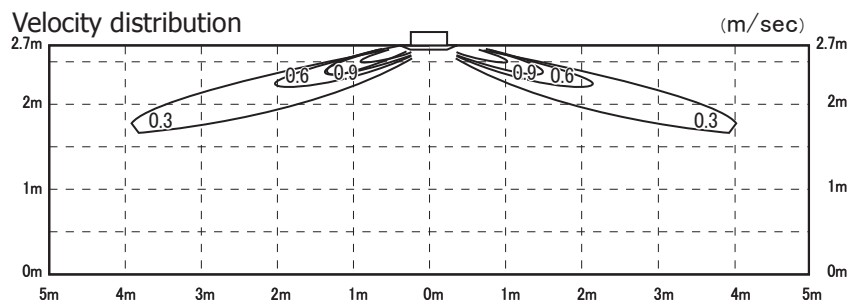
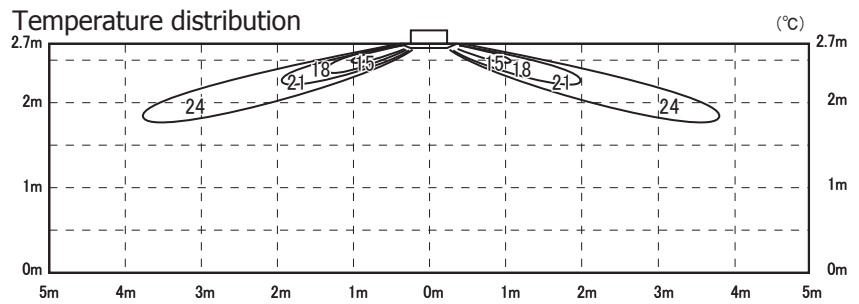
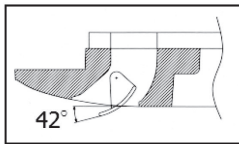

Heating Air flow: P-Hi

Louver position

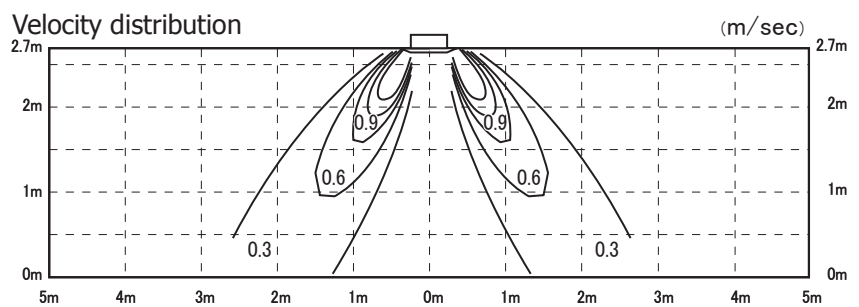
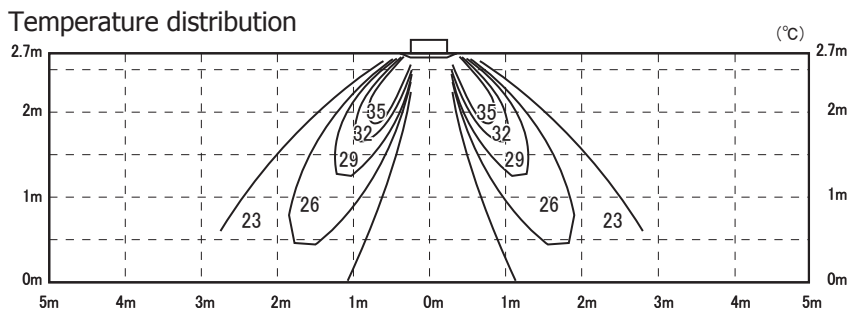
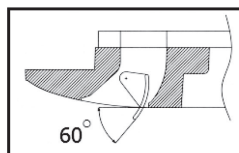

(3) Ceiling suspended type (FDE)

Model FDE40VH

Cooling Air flow: P-Hi

Louver position

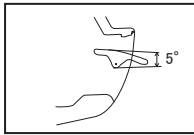

Temperature distribution

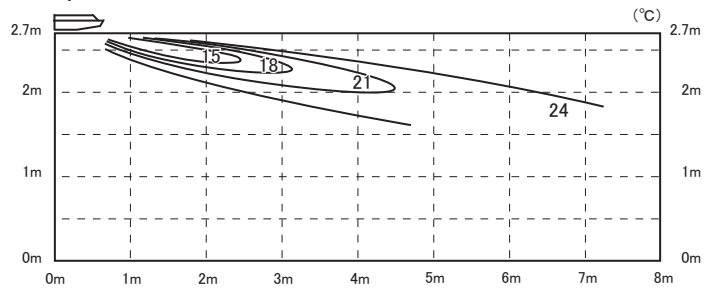

Velocity distribution

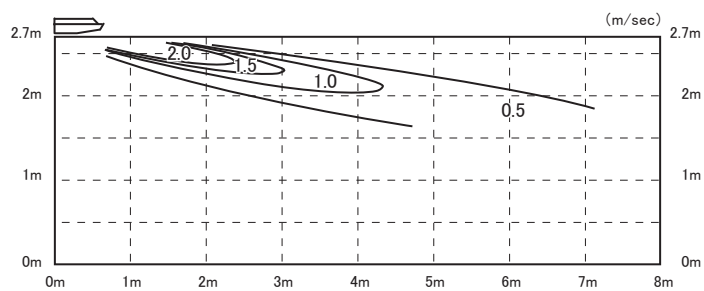

Heating Air flow: P-Hi

Louver position

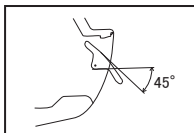

Temperature distribution

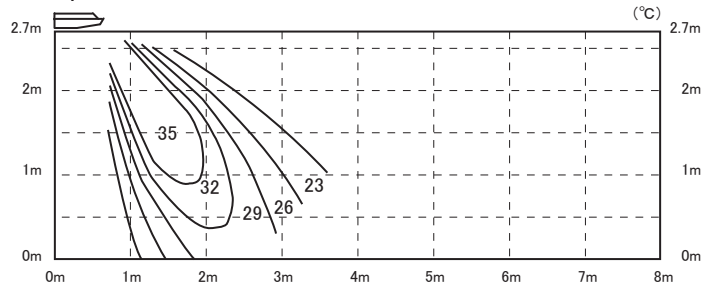

Velocity distribution

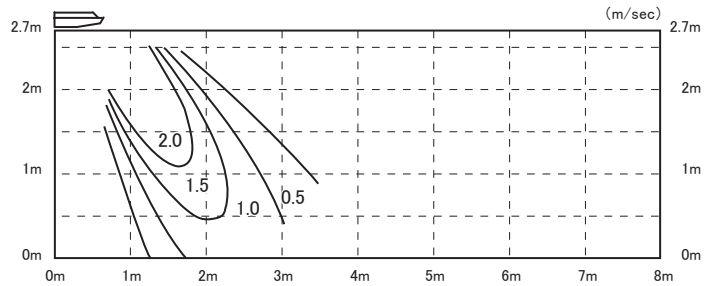

Model FDE71VH

Cooling Air flow: P-Hi

Louver position

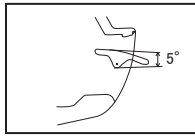

Temperature distribution

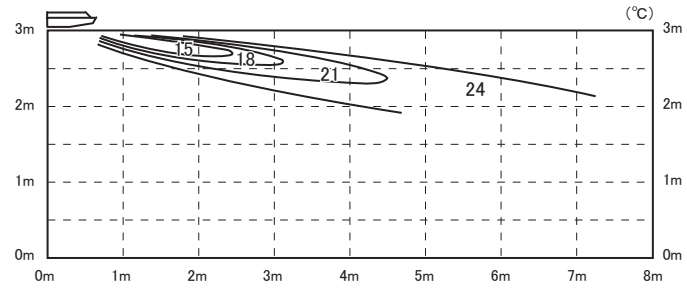

Velocity distribution

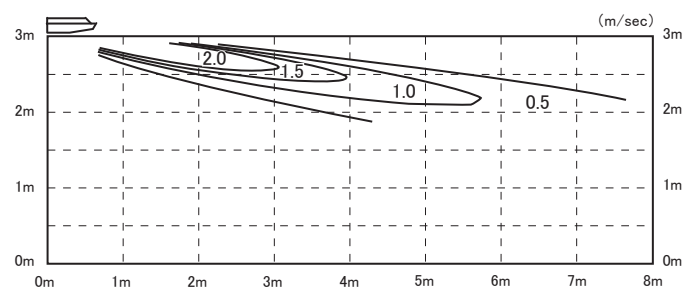

Heating Air flow: P-Hi

Louver position

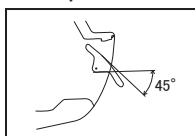

Temperature distribution

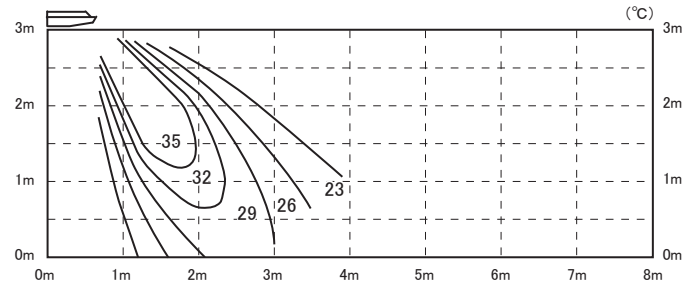

Velocity distribution

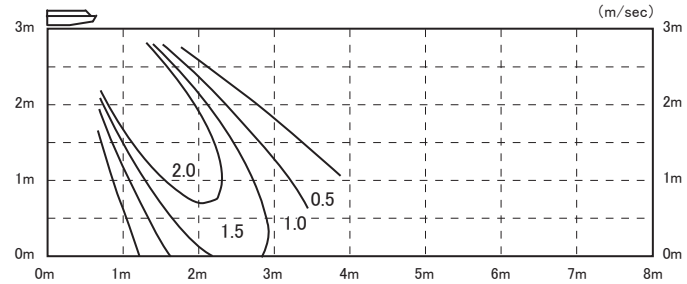

1.7 PIPING SYSTEM

(1) Single type

Model 71

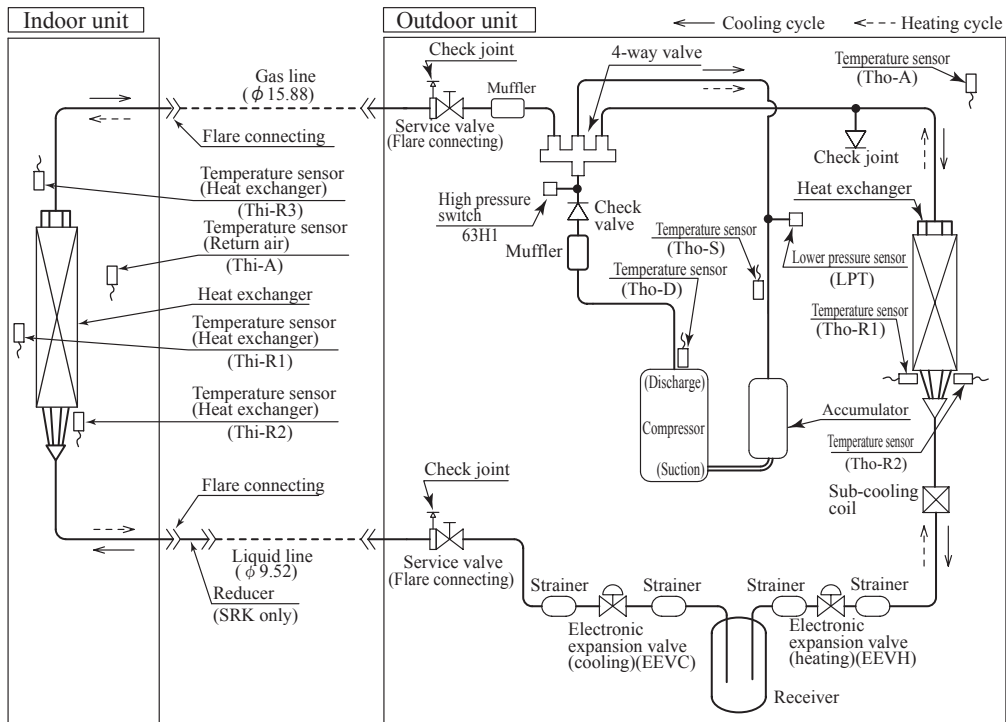

(2) Twin type

Model 71

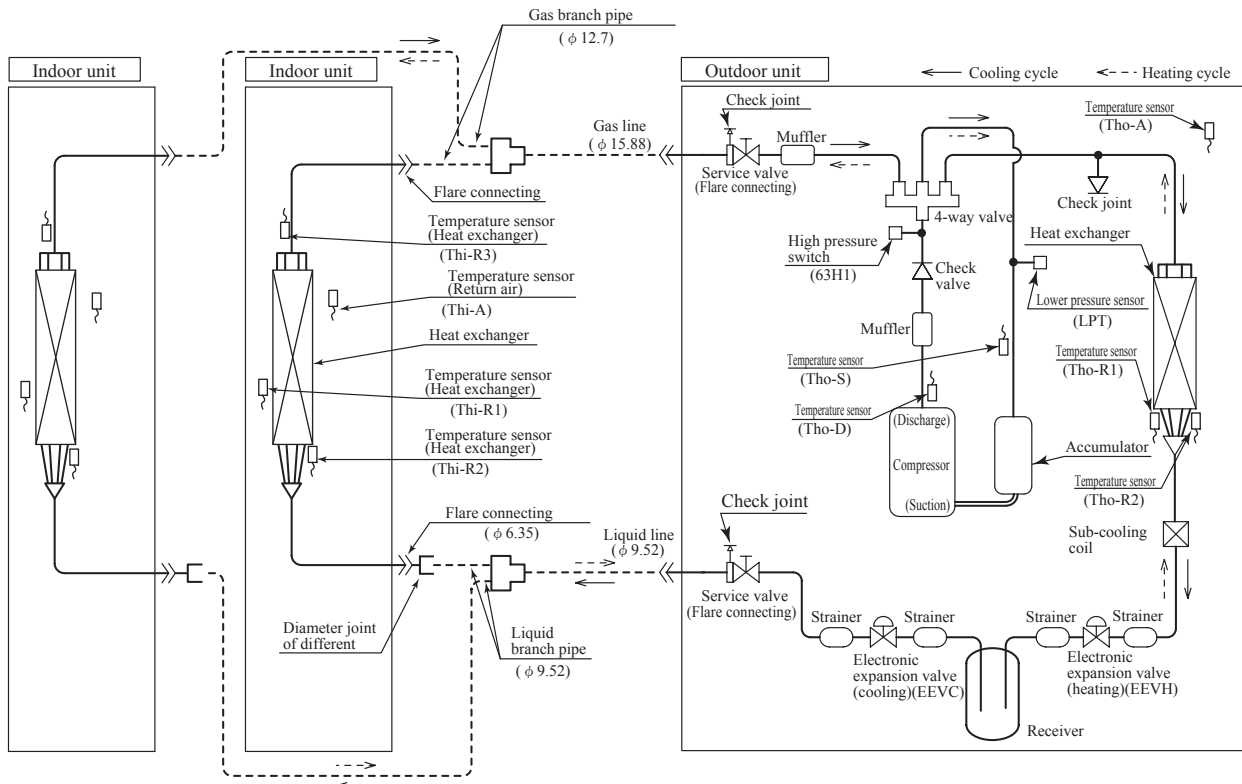

Preset point of the protective devices

Parts name	Mark	Equipped unit	71 model
Temperature sensor (for protection overloading in heating)	Thi-R	Indoor unit	OFF 63°C ON 56°C
Temperature sensor (for frost prevention)	Thi-R		OFF 1.0°C ON 10°C
Temperature sensor (for protection high pressure in cooling)	Tho-R	Outdoor unit	OFF 65°C ON 51°C
Temperature sensor (for detecting discharge pipe temperature)	Tho-D	Outdoor unit	OFF 115°C ON 85°C
High pressure switch (for protection)	63H1	Outdoor unit	OFF 4.15MPa ON 3.15MPa
Low pressure sensor (for protection)	LPT	Outdoor unit	OFF 0.079MPa ON 0.227MPa

1.8 RANGE OF USAGE & LIMITATIONS

Operating temperature range		See next page.
		When used below -5°C, install a snow hood (locally procured).
Recommendable area to install		Considering to get sufficient heating capacity, the area where the averaged lowest ambient air temperature in day time during winter is above 0°C, and it has no accumulation of snow.
Installation site		The limitations of installation space are shown in the page for exterior dimensions. Install the indoor unit at least 2.5m higher than the floor surface.
Temperature and humidity conditions surrounding the indoor unit in the ceiling (Note 2)		Model FDE Dew point temperature : 23°C or less, relative humidity : 80% or less Other models Dew point temperature : 28°C or less, relative humidity : 80% or less
Limitations on unit and piping installation		See pages 48.
Compressor ON-OFF cycling	Cycle Time	7 minutes or more (from OFF to OFF) or (from ON to ON)
	Stop Time	3 minutes or more
Power source	Voltage range	Rating ±10%
	Voltage drop at start-up	Min.85% of rating
	Phase-to-phase imbalance	3% or less

Note 1. Do not install the unit in places which :

- 1) Flammable gas may leak.
- 2) Carbon fiber, metal particles, powder, etc. are floating.
- 3) Cosmetic or special sprays are used frequently.
- 4) Exposed to oil splashes or steam (e.g. kitchen and machine plant).
- 5) Exposed to sea breeze (e.g. coastal area) or calcium chloride (e.g. snow melting agent).
- 6) Exposed to ammonia substance (e.g. organic fertilizer).
- 7) Matters affecting devices, such as sulfuric gas, chlorine gas, acid, alkali, etc. may generate or accumulate.
- 8) Chimney smoke is hanging.
- 9) Sucking the exhaust gas from heat exchanger.
- 10) Adjacent to equipment generating electromagnetic waves or high frequency waves.
- 11) There is light beams that affect the receiving device of indoor unit in case of the wireless specification.
- 12) Snow falls heavily.
- 13) At an elevation of 1000 meters or higher.
- 14) On mobile machine (e.g. vehicle, ship, etc.)
- 15) Splashed with water to indoor unit (e.g. laundry room).
- 16) Indoor units of twin and triple specifications separately in a room with partition.

Note 2. If ambient temperature and humidity exceed the above conditions, add polyurethane foam insulation (10mm or thicker) on the outer plate of indoor unit.

Note 3. Both gas and liquid pipes need to be covered with 20mm or thicker heat insulation materials at the place where humidity exceeds 70%.

Note 4. When snow accumulate, install a snow hood on site.

Note 5. The indoor unit shall be installed in a room with minimum installation area or more according to the refrigerant charge amount. (for details, refer to installation sheet)

PCA001Z881

Operating temperature range

■ Cooling

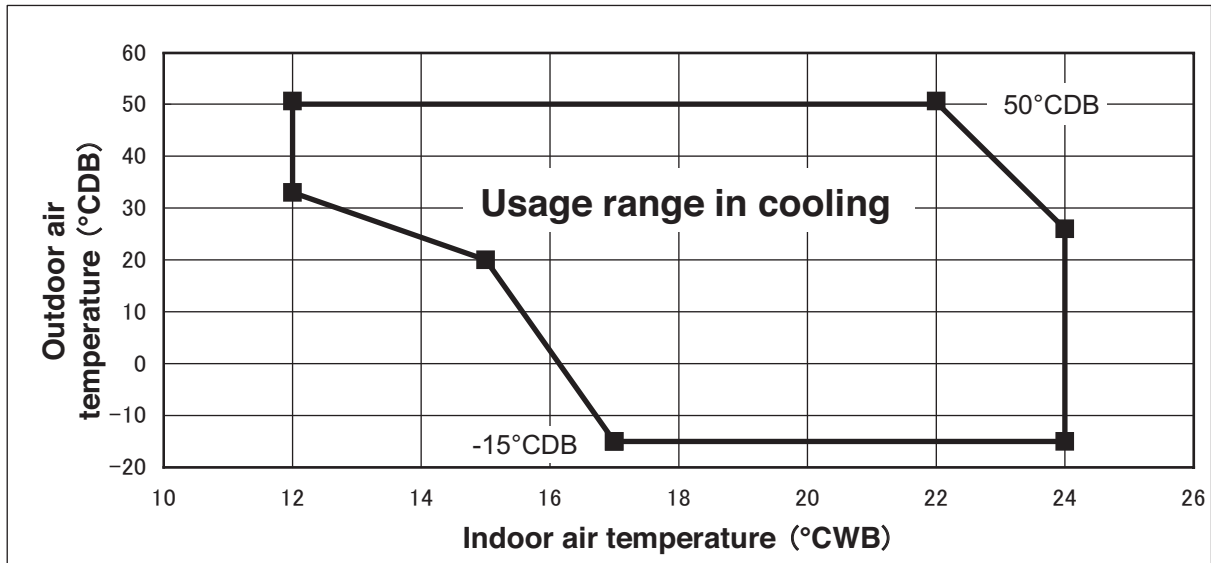

■ Heating

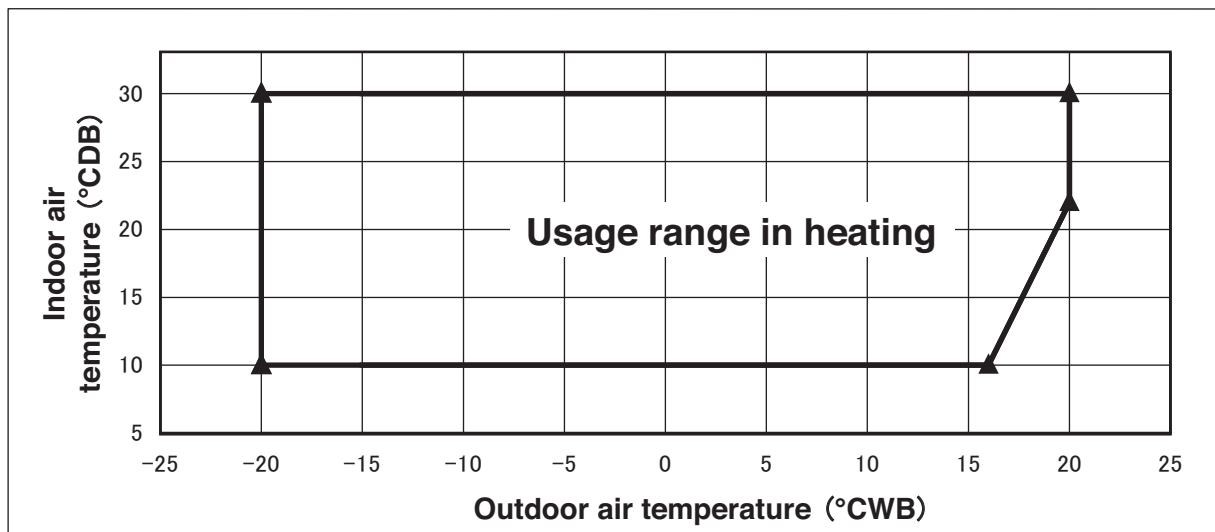

Decline in cooling and heating capacity or operation stop may occur when the outdoor unit is installed in places where natural wind can increase or decrease its design air flow rate.

PCA001Z881

“CAUTION” Cooling operation under low outdoor air temperature conditions

PAC models can be operated in cooling mode at low outdoor air temperature condition within above temperature range. However in case of severely low temperature conditions if the following precaution is not observed, it may not be operated in spite of operable temperature range mentioned above and cooling capacity may not be established under certain conditions.

[Precaution]

In case of severely low temperature condition

- 1) Install the outdoor unit at the place where strong wind cannot blow directly into the outdoor unit.
- 2) If there is no installation place where can prevent strong wind from directly blowing into the outdoor unit, mount the flex flow adapter (prepared as option part) or like such devices onto the outdoor unit in order to divert the strong wind.

[Reason]

Under the low outdoor air temperature conditions of -5°C or lower, the outdoor fan is controlled at lower or lowest speed by outdoor fan control, but if strong wind directly blow into the outdoor unit, the outdoor heat exchanger temperature will drop more. This makes high and low pressures to drop as well. This low pressure drop makes the indoor heat exchanger temperature to drop and will activate anti-frost control at indoor heat exchanger at frequent intervals, that cooling operation may not be established for any given time.

Limitation on unit and piping installation - single, twin.				
Descriptions	Model for outdoor units	Dimensional limitations	Marks appearing in the drawing	
			Single type	Twin type
One-way pipe length	71VNX - W	≤ 50m	L	L + L1 + L2
Main pipe length	71VNX - W	≤ 50m		L
One-way pipe length after the first branching point	71VNX - W	≤ 20m		L1, L2
Difference of pipe length after the first branching point		≤ 10m		L1-L2 L2-L1
Total pipe length after the second branching point		≤ 15m		
Elevation difference between indoor and outdoor units	When the outdoor unit is positioned higher	≤ 30m	H	H
	When the outdoor unit is positioned lower	≤ 15m		
Elevation difference among indoor units		≤ 0.5m		h

Single type

Twin type

Notes

(1) A riser pipe must be part of the main.
A branching pipe set should be installed horizontally at a point as close to an indoor unit as possible.

Model for outdoor units	Branch piping set(Optional)
71VNX-W	DIS-WA1G

Twin type

1.9 SELECTION CHART

Correct the cooling and heating capacity in accordance with the operating conditions. The net cooling and heating capacity can be obtained in the following way.

Net capacity = Capacity shown in the capacity tables (1.9.1) × Correction factors shown in the table (1.9.2) (1.9.3) (1.9.4).

Caution: In case that the cooling operation during low outdoor air temperature below -5°C is expected, install the outdoor unit where it is not influenced by natural wind. Otherwise protection control by low pressure will be activated much more frequently and it will cause insufficient capacity or breakdown of the compressor in worst case.

1.9.1 Capacity tables

(1) Ceiling cassette-4 way type (FDT)

(a) Single type

Model **FDT71VNXVWH** Indoor unit **FDT71VH** Outdoor unit **FDC71VNX-W**

Cooling Mode (kW)																Heating Mode:HC (kW)							
Outdoor air temp. °CDB	Indoor air temperature															Outdoor air temp. °CDB		Indoor air temperature °CDB					
	18 °CDB		21 °CDB		23 °CDB		26 °CDB		27 °CDB		28 °CDB		31 °CDB		33 °CDB		°CDB	°CWB	16	18	20	22	24
	12 °CWB	14 °CWB	16 °CWB	18 °CWB	19 °CWB	20 °CWB	22 °CWB	24 °CWB	TC	SHC	TC	SHC	TC	SHC	TC	SHC							
-19.8																	-19.8	-20	5.12	5.03	4.95	4.86	4.78
-17.7																	-17.7	-18	5.02	4.95	4.87	4.79	4.70
-15.7																	-15.7	-16	5.38	5.30	5.22	5.13	5.04
-13.5																	-13.5	-14	5.50	5.42	5.34	5.25	5.16
-11.5																	-11.5	-12	5.74	5.65	5.57	5.48	5.39
-9.5																	-9.5	-10	5.98	5.89	5.80	5.71	5.61
-7.5																	-7.5	-8	6.22	6.12	6.03	5.94	5.84
-5.5																	-5.5	-6	6.45	6.35	6.25	6.15	6.06
-3.0																	-3.0	-4	6.68	6.58	6.47	6.37	6.27
-1.0																	-1.0	-2	6.91	6.80	6.69	6.59	6.48
1.0																	1.0	0	7.14	7.03	6.92	6.81	6.70
2.0																	2.0	1	7.26	7.14	7.03	6.91	6.80
3.0																	3.0	2	7.42	7.32	7.22	7.11	6.99
5.0																	5.0	4	7.73	7.67	7.61	7.49	7.36
7.0																	7.0	6	8.05	8.02	8.00	7.87	7.74
9.0																	9.0	8	8.37	8.37	8.38	8.21	8.05
11.5																	11.5	10	8.69	8.72	8.76	8.56	8.35
13.5																	13.5	12	9.08	9.13	9.17	8.99	8.82
15.5																	15.5	14	9.48	9.53	9.58	9.43	9.28
16.5																	16.5	16	9.68	9.73	9.78	9.65	9.51

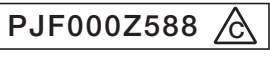

(b) Twin type

Model **FDT71VNXWVWH** Indoor unit **FDT40VH (2 units)** Outdoor unit **FDC71VNX-W**

Cooling Mode (kW)																Heating Mode:HC (kW)							
Outdoor air temp. °CDB	Indoor air temperature															Outdoor air temp. °CDB		Indoor air temperature °CDB					
	18 °CDB		21 °CDB		23 °CDB		26 °CDB		27 °CDB		28 °CDB		31 °CDB		33 °CDB		°CDB	°CWB	16	18	20	22	24
	12 °CWB	14 °CWB	16 °CWB	18 °CWB	19 °CWB	20 °CWB	22 °CWB	24 °CWB	TC	SHC	TC	SHC	TC	SHC	TC	SHC							
-19.8																	-19.8	-20	5.17	5.09	5.00	4.91	4.83
-17.7																	-17.7	-18	5.06	4.99	4.91	4.82	4.74
-15.7																	-15.7	-16	5.40	5.32	5.24	5.16	5.07
-13.5																	-13.5	-14	5.52	5.44	5.35	5.27	5.18
-11.5																	-11.5	-12	5.75	5.66	5.58	5.49	5.39
-9.5																	-9.5	-10	5.98	5.89	5.80	5.71	5.61
-7.5																	-7.5	-8	6.20	6.11	6.02	5.93	5.83
-5.5																	-5.5	-6	6.44	6.34	6.24	6.15	6.05
-3.0																	-3.0	-4	6.67	6.57	6.47	6.37	6.26
-1.0																	-1.0	-2	6.91	6.80	6.69	6.59	6.48
1.0																	1.0	0	7.14	7.03	6.92	6.80	6.69
2.0																	2.0	1	7.26	7.14	7.03	6.91	6.80
3.0																	3.0	2	7.42	7.32	7.22	7.11	6.99
5.0																	5.0	4	7.73	7.67	7.61	7.49	7.36
7.0																	7.0	6	8.05	8.02	8.00	7.87	7.74
9.0																	9.0	8	8.37	8.37	8.38	8.21	8.05
11.5																	11.5	10	8.69	8.72	8.76	8.56	8.35
13.5																	13.5	12	9.08	9.13	9.17	8.99	8.82
15.5																	15.5	14	9.48	9.53	9.58	9.43	9.28
16.5																	16.5	16	9.68	9.73	9.78	9.65	9.51

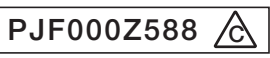

- Notes(1) These data show average status.
 Depending on the system control, there may be ranges where the operation is not conducted continuously.
 These data show the case where the operation frequency of a compressor is fixed. (Cooling only)
 In the heating mode in which the outside air temperature is 0°CDB or less, the compressor operates at maximum frequency.
- (2) Capacities are based on the following conditions.
 Corresponding refrigerant piping length :7.5m
 Level difference of Zero.
- (3) Symbols are as follows
 TC :Total cooling capacity (kW)
 SHC :Sensible heat capacity (kW)
 HC :Heating capacity (kW)

(2) Ceiling cassette-4 way compact type (FDTC)

(a) Twin type

Model FDTC71VNXWPVH Indoor unit FDTC40VH (2 units) Outdoor unit FDC71VNX-W

Cooling Mode		(kW)														Heating Mode:HC						(kW)					
Outdoor air temp.	Indoor air temperature																										
	18 °CDB		21 °CDB		23 °CDB		26 °CDB		27 °CDB		28 °CDB		31 °CDB		33 °CDB		Outdoor air temp.		Indoor air temperature								
	12 °CWB		14 °CWB		16 °CWB		18 °CWB		19 °CWB		20 °CWB		22 °CWB		24 °CWB		°CDB	°CWB	16	18	20	22	24				
°CDB	TC	SHC	TC	SHC	TC	SHC	TC	SHC	TC	SHC	TC	SHC	TC	SHC	TC	SHC	°CDB	°CWB	16	18	20	22	24				
-19.8																	-19.8	-20	4.45	4.38	4.30	4.23	4.15				
-17.7																	-17.7	-18	4.59	4.52	4.45	4.37	4.29				
-15.7																	-15.7	-16	5.19	5.11	5.03	4.95	4.86				
-13.5																	-13.5	-14	5.38	5.30	5.22	5.14	5.05				
-11.5																	-11.5	-12	5.78	5.70	5.61	5.52	5.43				
-9.5																	-9.5	-10	6.18	6.09	6.00	5.90	5.81				
-7.5																	-7.5	-8	6.58	6.48	6.38	6.28	6.18				
-5.5																	-5.5	-6	6.73	6.63	6.53	6.42	6.32				
-3.0																	-3.0	-4	6.88	6.78	6.67	6.56	6.46				
-1.0																	-1.0	-2	7.03	6.92	6.81	6.70	6.60				
1.0																	1.0	0	7.19	7.07	6.96	6.84	6.73				
2.0																	2.0	1	7.26	7.14	7.03	6.91	6.80				
3.0																	3.0	2	7.42	7.32	7.22	7.11	6.99				
5.0																	5.0	4	7.73	7.67	7.61	7.49	7.36				
7.0																	7.0	6	8.05	8.02	8.00	7.87	7.74				
9.0																	9.0	8	8.37	8.37	8.38	8.21	8.05				
11.5																	11.5	10	8.69	8.72	8.76	8.56	8.35				
13.5																	13.5	12	9.08	9.13	9.17	8.99	8.82				
15.5																	15.5	14	9.48	9.53	9.58	9.43	9.28				
16.5																	16.5	16	9.68	9.73	9.78	9.65	9.51				

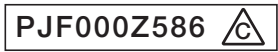

(3) Duct connected-High static pressure type (FDU)

(a) Single type

Model FDU71VNXWVH Indoor unit FDU71VH Outdoor unit FDC71VNX-W

Cooling Mode		(kW)														Heating Mode:HC						(kW)					
Outdoor air temp.	Indoor air temperature																										
	18 °CDB		21 °CDB		23 °CDB		26 °CDB		27 °CDB		28 °CDB		31 °CDB		33 °CDB		Outdoor air temp.		Indoor air temperature								
	12 °CWB		14 °CWB		16 °CWB		18 °CWB		19 °CWB		20 °CWB		22 °CWB		24 °CWB		°CDB	°CWB	16	18	20	22	24				
°CDB	TC	SHC	TC	SHC	TC	SHC	TC	SHC	TC	SHC	TC	SHC	TC	SHC	TC	SHC	°CDB	°CWB	16	18	20	22	24				
-19.8																	-19.8	-20	5.17	5.09	5.00	4.91	4.83				
-17.7																	-17.7	-18	5.35	5.26	5.18	5.09	5.00				
-15.7																	-15.7	-16	5.52	5.44	5.36	5.27	5.18				
-13.5																	-13.5	-14	5.65	5.57	5.49	5.40	5.30				
-11.5																	-11.5	-12	5.92	5.83	5.74	5.65	5.56				
-9.5																	-9.5	-10	6.18	6.09	6.00	5.90	5.81				
-7.5																	-7.5	-8	6.45	6.35	6.26	6.16	6.06				
-5.5																	-5.5	-6	6.63	6.53	6.43	6.33	6.23				
-3.0																	-3.0	-4	6.81	6.70	6.60	6.49	6.39				
-1.0																	-1.0	-2	6.99	6.88	6.77	6.66	6.56				
1.0																	1.0	0	7.17	7.06	6.94	6.83	6.72				
2.0																	2.0	1	7.26	7.14	7.03	6.91	6.80				
3.0																	3.0	2	7.42	7.32	7.22	7.11	6.99				
5.0																	5.0	4	7.73	7.67	7.61	7.49	7.36				
7.0																	7.0	6	8.05	8.02	8.00	7.87	7.74				
9.0																	9.0	8	8.37	8.37	8.38	8.21	8.05				
11.5																	11.5	10	8.69	8.72	8.76	8.56	8.35				
13.5																	13.5	12	9.08	9.13	9.17	8.99	8.82				
15.5																	15.5	14	9.48	9.53	9.58	9.43	9.28				
16.5																	16.5	16	9.68	9.73	9.78	9.65	9.51				

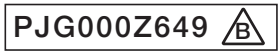

Notes(1) These data show average status.

Depending on the system control, there may be ranges where the operation is not conducted continuously. These data show the case where the operation frequency of a compressor is fixed. (Cooling only)
 In the heating mode in which the outside air temperature is 0°CDB or less, the compressor operates at maximum frequency.

(2) Capacities are based on the following conditions.

Corresponding refrigerant piping length :7.5m
 Level difference of Zero.

(3) Symbols are as follows

TC :Total cooling capacity (kW)
 SHC :Sensible heat capacity (kW)
 HC :Heating capacity (kW)

(4) Duct connected-Low / Middle static pressure type (FDUM)
(a) Single type

Model **FDUM71VNXWWH** Indoor unit **FDUM71VH** Outdoor unit **FDC71VNX-W**

Cooling Mode																	(kW) Heating Mode:HC						
Outdoor air temp.	Indoor air temperature																Outdoor air temp.		Indoor air temperature				
	18 °CDB		21 °CDB		23 °CDB		26 °CDB		27 °CDB		28 °CDB		31 °CDB		33 °CDB		°CDB	°CWB	°CDB				
	12 °CWB		14 °CWB		16 °CWB		18 °CWB		19 °CWB		20 °CWB		22 °CWB		24 °CWB				16	18	20	22	24
°CDB	TC	SHC	TC	SHC	TC	SHC	TC	SHC	TC	SHC	TC	SHC	TC	SHC	TC	SHC	°CDB	°CWB	16	18	20	22	24
-15							6.36	5.69	6.54	5.63	6.74	5.58	7.15	5.92	7.55	5.78	-19.8	-20	5.17	5.09	5.00	4.91	4.83
-10							6.36	5.69	6.54	5.63	6.74	5.58	7.15	5.92	7.55	5.78	-17.7	-18	5.35	5.26	5.18	5.09	5.00
-5							6.36	5.69	6.54	5.63	6.74	5.58	7.15	5.92	7.55	5.78	-15.7	-16	5.52	5.44	5.36	5.27	5.18
0					5.98	5.22	6.36	5.69	6.54	5.63	6.74	5.58	7.15	5.92	7.55	5.78	-13.5	-14	5.65	5.57	5.49	5.40	5.30
5					5.98	5.22	6.36	5.69	6.54	5.63	6.74	5.58	7.15	5.92	7.55	5.78	-11.5	-12	5.92	5.83	5.74	5.65	5.56
11					5.98	5.22	6.36	5.69	6.54	5.63	6.74	5.58	7.15	5.92	7.55	5.78	-9.5	-10	6.18	6.09	6.00	5.90	5.81
13					5.98	5.22	6.36	5.69	6.54	5.63	6.74	5.58	7.15	5.92	7.55	5.78	-7.5	-8	6.45	6.35	6.26	6.16	6.06
15					5.98	5.22	6.36	5.69	6.54	5.63	6.74	5.58	7.15	5.92	7.55	5.78	-5.5	-6	6.63	6.53	6.43	6.33	6.23
17					6.40	5.38	6.81	5.84	7.01	5.78	7.23	5.72	7.66	6.06	8.10	5.91	-3.0	-4	6.81	6.70	6.60	6.49	6.39
19					6.83	5.54	7.26	5.99	7.47	5.93	7.71	5.87	8.18	6.20	8.65	6.05	-1.0	-2	6.99	6.88	6.77	6.66	6.56
21					6.78	5.52	7.20	5.97	7.41	5.91	7.65	5.85	8.13	6.19	8.61	6.04	1.0	0	7.17	7.06	6.94	6.83	6.72
23					6.72	5.50	7.14	5.95	7.35	5.89	7.60	5.84	8.08	6.17	8.57	6.03	2.0	1	7.26	7.14	7.03	6.91	6.80
25			6.28	5.66	6.69	5.48	7.11	5.94	7.33	5.88	7.57	5.83	8.06	6.17	8.55	6.02	3.0	2	7.42	7.32	7.22	7.11	6.99
27			6.25	5.65	6.66	5.47	7.08	5.93	7.30	5.87	7.64	5.85	7.99	6.15			5.0	4	7.73	7.67	7.61	7.49	7.36
29			6.11	5.60	6.53	5.42	6.99	5.90	7.25	5.86	7.55	5.82	7.86	6.11			7.0	6	8.05	8.02	8.00	7.87	7.74
31			5.98	5.54	6.39	5.37	6.90	5.87	7.20	5.84	7.46	5.79	7.73	6.08			9.0	8	8.37	8.37	8.38	8.21	8.05
33	5.52	5.09	5.78	5.46	6.26	5.32	6.81	5.84	7.15	5.83	7.37	5.77	7.60	6.04			11.5	10	8.69	8.72	8.76	8.56	8.35
35	5.33	5.01	5.62	5.40	6.12	5.27	6.72	5.81	7.10	5.81	7.28	5.74	7.47	6.01			13.5	12	9.08	9.13	9.17	8.99	8.82
37	5.20	4.96	5.48	5.34	5.96	5.21	6.50	5.74	6.85	5.73	7.05	5.67	7.26	5.95			15.5	14	9.48	9.53	9.58	9.43	9.28
39	5.06	4.90	5.34	5.23	5.79	5.15	6.28	5.66	6.60	5.65	6.82	5.60	7.04	5.89			16.5	16	9.68	9.73	9.78	9.65	9.51
41	4.93	4.83	5.20	5.10	5.62	5.10	6.06	5.59	6.34	5.57	6.59	5.53	6.83	5.84									
43	4.80	4.70	5.06	4.96	5.46	5.04	5.84	5.52	6.09	5.49	6.36	5.46	6.62	5.78									
46	4.60	4.51	4.85	4.75	5.21	4.95	5.52	5.41	5.71	5.38	6.01	5.36	6.31	5.70									
50	3.73	3.66	3.96	3.88	4.29	4.21	4.59	4.50	4.77	4.68	4.91	4.81	5.05	4.94									

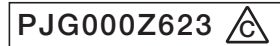

(b) Twin type

Model **FDUM71VNXWVPVH** Indoor unit **FDUM40VH (2 units)** Outdoor unit **FDC71VNX-W**

Cooling Mode																	(kW) Heating Mode:HC						
Outdoor air temp.	Indoor air temperature																Outdoor air temp.		Indoor air temperature				
	18 °CDB		21 °CDB		23 °CDB		26 °CDB		27 °CDB		28 °CDB		31 °CDB		33 °CDB		°CDB	°CWB	°CDB				
	12 °CWB		14 °CWB		16 °CWB		18 °CWB		19 °CWB		20 °CWB		22 °CWB		24 °CWB				16	18	20	22	24
°CDB	TC	SHC	TC	SHC	TC	SHC	TC	SHC	TC	SHC	TC	SHC	TC	SHC	TC	SHC	°CDB	°CWB	16	18	20	22	24
-15							6.36	6.23	6.54	6.35	6.74	6.32	7.15	6.74	7.55	6.65	-19.8	-20	5.17	5.09	5.00	4.91	4.83
-10							6.36	6.23	6.54	6.35	6.74	6.32	7.15	6.74	7.55	6.65	-17.7	-18	5.35	5.26	5.18	5.09	5.00
-5							6.36	6.23	6.54	6.35	6.74	6.32	7.15	6.74	7.55	6.65	-15.7	-16	5.52	5.44	5.36	5.27	5.18
0					5.98	5.83	6.36	6.23	6.54	6.35	6.74	6.32	7.15	6.74	7.55	6.65	-13.5	-14	5.65	5.57	5.49	5.40	5.30
5					5.98	5.83	6.36	6.23	6.54	6.35	6.74	6.32	7.15	6.74	7.55	6.65	-11.5	-12	5.92	5.83	5.74	5.65	5.56
11					5.98	5.83	6.36	6.23	6.54	6.35	6.74	6.32	7.15	6.74	7.55	6.65	-9.5	-10	6.18	6.09	6.00	5.90	5.81
13					5.98	5.83	6.36	6.23	6.54	6.35	6.74	6.32	7.15	6.74	7.55	6.65	-7.5	-8	6.45	6.35	6.26	6.16	6.06
15					5.98	5.83	6.36	6.23	6.54	6.35	6.74	6.32	7.15	6.74	7.55	6.65	-5.5	-6	6.63	6.53	6.43	6.33	6.23
17					6.40	6.01	6.81	6.56	7.01	6.52	7.23	6.48	7.66	6.91	8.10	6.81	-3.0	-4	6.81	6.70	6.60	6.49	6.39
19					6.83	6.18	7.26	6.73	7.47	6.69	7.71	6.65	8.18	7.07	8.65	6.98	-1.0	-2	6.99	6.88	6.77	6.66	6.56
21					6.78	6.16	7.20	6.71	7.41	6.67	7.65	6.64	8.13	7.06	8.61	6.96	1.0	0	7.17	7.06	6.94	6.83	6.72
23					6.72	6.14	7.14	6.68	7.35	6.65	7.60	6.62	8.08	7.04	8.57	6.95	2.0	1	7.26	7.14	7.03	6.91	6.80
25			6.28	6.15	6.69	6.12	7.11	6.67	7.33	6.64	7.57	6.61	8.06	7.04	8.55	6.95	3.0	2	7.42	7.32	7.22	7.11	6.99
27			6.25	6.12	6.66	6.11	7.08	6.66	7.30	6.62	7.64	6.63	7.99	7.01			5.0	4	7.73	7.67	7.61	7.49	7.36
29			6.11	5.99	6.53	6.06	6.99	6.63	7.25	6.61	7.55	6.60	7.86	6.97			7.0	6	8.05	8.02	8.00	7.87	7.74
31			5.98	5.86	6.39	6.00	6.90	6.59	7.20	6.59	7.46	6.57	7.73	6.93			9.0	8	8.37	8.37	8.38	8.21	8.05
33	5.52	5.41	5.78	5.67	6.26	5.95	6.81	6.56	7.15	6.57	7.37	6.54	7.60	6.89			11.5	10	8.69	8.72	8.76	8.56	8.35
35	5.33	5.22	5.62	5.51	6.12	5.89	6.72	6.52	7.10	6.55	7.28	6.50	7.47	6.84			13.5	12	9.08	9.13	9.17	8.99	8.82
37	5.20	5.09	5.48	5.37	5.96	5.82	6.50	6.37	6.85	6.46	7.05	6.42	7.26	6.77			15.5	14	9.48	9.53	9.58	9.43	9.28
39	5.06	4.96	5.34	5.23	5.79	5.67	6.28	6.15	6.60	6.37	6.82	6.34	7.04	6.71			16.5	16	9.68	9.73	9.78	9.65	9.51
41	4.93	4.83	5.20	5.10	5.62	5.51	6.06	5.94	6.34	6.22	6.59	6.26	6.83	6.64									
43	4.80	4.70	5.06	4.96	5.46	5.35	5.84	5.73	6.09	5.97	6.36	6.18	6.62	6.49									
46	4.60	4.51	4.85	4.75	5.21	5.11	5.52	5.41	5.71	5.60	6.01	5.89	6.31	6.18									
50	3.73	3.66	3.96	3.88	4.29	4.21	4.59	4.50	4.77	4.68	4.91	4.81	5.05	4.94									

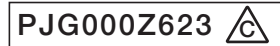

- Notes(1) These data show average status.
 Depending on the system control, there may be ranges where the operation is not conducted continuously.
 These data show the case where the operation frequency of a compressor is fixed. (Cooling only)
 In the heating mode in which the outside air temperature is 0°CDB or less, the compressor operates at maximum frequency.
- (2) Capacities are based on the following conditions.
 Corresponding refrigerant piping length :7.5m
 Level difference of Zero.
- (3) Symbols are as follows
 TC :Total cooling capacity (kW)
 SHC :Sensible heat capacity (kW)
 HC :Heating capacity (kW)

(5) Ceiling suspended type (FDE)
(a) Single type

Model FDE71VNXWVH Indoor unit FDE71VH Outdoor unit FDC71VNX-W

Cooling Mode (kW) Heating Mode:HC (kW)

Outdoor air temp. °CDB	Indoor air temperature																
	18 °CDB		21 °CDB		23 °CDB		26 °CDB		27 °CDB		28 °CDB		31 °CDB		33 °CDB		
	TC	SHC	TC	SHC	TC	SHC	TC	SHC	TC	SHC	TC	SHC	TC	SHC	TC	SHC	
-15						6.36	5.38	6.54	5.34	6.74	5.30	7.15	5.61	7.55	5.51		
-10						6.36	5.38	6.54	5.34	6.74	5.30	7.15	5.61	7.55	5.51		
-5						6.36	5.38	6.54	5.34	6.74	5.30	7.15	5.61	7.55	5.51		
0					5.98	4.97	6.36	5.38	6.54	5.34	6.74	5.30	7.15	5.61	7.55	5.51	
5					5.98	4.97	6.36	5.38	6.54	5.34	6.74	5.30	7.15	5.61	7.55	5.51	
11					5.98	4.97	6.36	5.38	6.54	5.34	6.74	5.30	7.15	5.61	7.55	5.51	
13					5.98	4.97	6.36	5.38	6.54	5.34	6.74	5.30	7.15	5.61	7.55	5.51	
15					5.98	4.97	6.36	5.38	6.54	5.34	6.74	5.30	7.15	5.61	7.55	5.51	
17					6.40	5.15	6.81	5.56	7.01	5.51	7.23	5.48	7.66	5.78	8.10	5.67	
19					6.83	5.33	7.26	5.73	7.47	5.69	7.71	5.65	8.18	5.95	8.65	5.84	
21					6.78	5.31	7.20	5.71	7.41	5.67	7.65	5.63	8.13	5.93	8.61	5.83	
23					6.72	5.29	7.14	5.69	7.35	5.65	7.60	5.61	8.08	5.92	8.57	5.81	
25				6.28	5.40	6.69	5.27	7.11	5.68	7.33	5.64	7.57	5.80	8.06	5.91	8.55	5.81
27				6.25	5.39	6.66	5.26	7.08	5.66	7.30	5.62	7.64	5.63	7.99	5.88		
29				6.11	5.33	6.53	5.20	6.99	5.63	7.25	5.61	7.55	5.60	7.86	5.84		
31				5.98	5.26	6.39	5.15	6.90	5.59	7.20	5.59	7.46	5.56	7.73	5.80		
33	5.52	4.86		5.78	5.18	6.26	5.09	6.81	5.56	7.15	5.57	7.37	5.53	7.60	5.75		
35	5.33	4.77		5.62	5.10	6.12	5.03	6.72	5.52	7.10	5.55	7.28	5.50	7.47	5.71		
37	5.20	4.70		5.48	5.04	5.96	4.96	6.50	5.44	6.85	5.46	7.05	5.41	7.26	5.64		
39	5.06	4.64		5.34	4.98	5.79	4.90	6.28	5.35	6.60	5.36	6.82	5.33	7.04	5.57		
41	4.93	4.58		5.20	4.92	5.62	4.83	6.06	5.27	6.34	5.27	6.59	5.25	6.83	5.51		
43	4.80	4.51		5.06	4.85	5.46	4.76	5.84	5.19	6.09	5.18	6.36	5.17	6.62	5.44		
46	4.60	4.42		4.85	4.75	5.21	4.66	5.52	5.06	5.71	5.04	6.01	5.05	6.31	5.34		
50	3.73	3.66		3.96	3.88	4.29	4.21	4.59	4.50	4.77	4.68	4.91	4.68	5.05	4.94		

Outdoor air temp. °CDB	°CWB	Indoor air temperature °CDB				
		16	18	20	22	24
		-19.8	-20	4.44	4.37	4.30
-17.7	-18	4.59	4.52	4.45	4.37	4.29
-15.7	-16	5.19	5.11	5.03	4.95	4.86
-13.5	-14	5.39	5.31	5.23	5.14	5.05
-11.5	-12	5.79	5.70	5.62	5.53	5.43
-9.5	-10	6.19	6.10	6.00	5.91	5.81
-7.5	-8	6.59	6.49	6.39	6.29	6.19
-5.5	-6	6.74	6.64	6.53	6.43	6.33
-3.0	-4	6.89	6.78	6.67	6.57	6.46
-1.0	-2	7.04	6.93	6.82	6.71	6.60
1.0	0	7.19	7.07	6.96	6.85	6.73
2.0	1	7.26	7.14	7.03	6.91	6.80
3.0	2	7.42	7.32	7.22	7.11	6.99
5.0	4	7.73	7.67	7.61	7.49	7.36
7.0	6	8.05	8.02	8.00	7.87	7.74
9.0	8	8.37	8.37	8.38	8.21	8.05
11.5	10	8.69	8.72	8.76	8.56	8.35
13.5	12	9.08	9.13	9.17	8.99	8.82
15.5	14	9.48	9.53	9.58	9.43	9.28
16.5	16	9.68	9.73	9.78	9.65	9.51

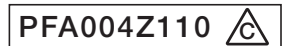

(b) Twin type

Model FDE71VNXWPVH Indoor unit FDE40VH (2 units) Outdoor unit FDC71VNX-W

Cooling Mode (kW) Heating Mode:HC (kW)

Outdoor air temp. °CDB	Indoor air temperature																
	18 °CDB		21 °CDB		23 °CDB		26 °CDB		27 °CDB		28 °CDB		31 °CDB		33 °CDB		
	TC	SHC	TC	SHC	TC	SHC	TC	SHC	TC	SHC	TC	SHC	TC	SHC	TC	SHC	
-15						6.36	6.23	6.54	6.24	6.74	6.20	7.15	6.61	7.55	6.51		
-10						6.36	6.23	6.54	6.24	6.74	6.20	7.15	6.61	7.55	6.51		
-5						6.36	6.23	6.54	6.24	6.74	6.20	7.15	6.61	7.55	6.51		
0					5.98	5.74	6.36	6.23	6.54	6.24	6.74	6.20	7.15	6.61	7.55	6.51	
5					5.98	5.74	6.36	6.23	6.54	6.24	6.74	6.20	7.15	6.61	7.55	6.51	
11					5.98	5.74	6.36	6.23	6.54	6.24	6.74	6.20	7.15	6.61	7.55	6.51	
13					5.98	5.74	6.36	6.23	6.54	6.24	6.74	6.20	7.15	6.61	7.55	6.51	
15					5.98	5.74	6.36	6.23	6.54	6.24	6.74	6.20	7.15	6.61	7.55	6.51	
17					6.40	5.91	6.81	6.45	7.01	6.40	7.23	6.36	7.66	6.77	8.10	6.67	
19					6.83	6.08	7.26	6.61	7.47	6.57	7.71	6.53	8.18	6.93	8.65	6.82	
21					6.78	6.06	7.20	6.59	7.41	6.55	7.65	6.51	8.13	6.92	8.61	6.81	
23					6.72	6.03	7.14	6.57	7.35	6.53	7.60	6.49	8.08	6.90	8.57	6.80	
25				6.28	6.15	6.69	6.02	7.11	6.56	7.33	6.52	7.57	6.48	8.06	6.90	8.55	6.79
27				6.25	6.12	6.66	6.01	7.08	6.55	7.30	6.51	7.64	6.50	7.99	6.87		
29				6.11	5.99	6.53	5.96	6.99	6.52	7.25	6.49	7.55	6.47	7.86	6.83		
31				5.98	5.86	6.39	5.90	6.90	6.48	7.20	6.47	7.46	6.44	7.73	6.79		
33	5.52	5.41		5.78	5.67	6.26	5.85	6.81	6.45	7.15	6.45	7.37	6.41	7.60	6.75		
35	5.33	5.22		5.62	5.51	6.12	5.80	6.72	6.41	7.10	6.44	7.28	6.38	7.47	6.71		
37	5.20	5.09		5.48	5.37	5.96	5.73	6.50	6.33	6.85	6.35	7.05	6.30	7.26	6.65		
39	5.06	4.96		5.34	5.23	5.79	5.67	6.28	6.15	6.60	6.26	6.82	6.23	7.04	6.58		
41	4.93	4.83		5.20	5.10	5.62	5.51	6.06	5.94	6.34	6.17	6.59	6.15	6.83	6.52		
43	4.80	4.70		5.06	4.96	5.46	5.35	5.84	5.73	6.09	5.97	6.36	6.07	6.62	6.46		
46	4.60	4.51		4.85	4.75	5.21	5.11	5.52	5.41	5.71	5.60	6.01	5.89	6.31	6.18		
50	3.73	3.66		3.96	3.88	4.29	4.21	4.59	4.50	4.77	4.68	4.91	4.81	5.05	4.94		

Outdoor air temp. °CDB	°CWB	Indoor air temperature °CDB				
		16	18	20	22	24
		-19.8	-20	4.44	4.37	4.30
-17.7	-18	4.59	4.52	4.45	4.37	4.29
-15.7	-16	5.19	5.11	5.03	4.95	4.86
-13.5	-14	5.39	5.31	5.23	5.14	5.05
-11.5	-12	5.79	5.70	5.62	5.53	5.43
-9.5	-10	6.19	6.10	6.00	5.91	5.81
-7.5	-8	6.59	6.49	6.39	6.29	6.19
-5.5	-6	6.74	6.64	6.53	6.43	6.33
-3.0	-4	6.89	6.78	6.67	6.57	6.46
-1.0	-2	7.04	6.93	6.82	6.71	6.60
1.0	0	7.19	7.07	6.96	6.85	6.73
2.0	1	7.26	7.14	7.03	6.91	6.80
3.0	2	7.42	7.32	7.22	7.11	6.99
5.0	4	7.73	7.67	7.61	7.49	7.36
7.0	6	8.05	8.02	8.00	7.87	7.74
9.0	8	8.37	8.37	8.38	8.21	8.05
11.5	10	8.69	8.72	8.76	8.56	8.35
13.5	12	9.08	9.13	9.17	8.99	8.82
15.5	14	9.48	9.53	9.58	9.43	9.28
16.5	16	9.68	9.73	9.78	9.65	9.51

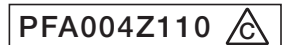

Notes(1) These data show average status.

Depending on the system control, there may be ranges where the operation is not conducted continuously. These data show the case where the operation frequency of a compressor is fixed. (Cooling only)
In the heating mode in which the outside air temperature is 0°CDB or less, the compressor operates at maximum frequency.

(2) Capacities are based on the following conditions.

Corresponding refrigerant piping length :7.5m

Level difference of Zero.

(3) Symbols are as follows

TC :Total cooling capacity (kW)

SHC :Sensible heat capacity (kW)

HC :Heating capacity (kW)

(6) Wall mounted type (SRK)

(a) Single type

Model **SRK71VNXWZR**

Indoor unit **SRK71ZR-W**

Outdoor unit **FDC71VNX-W**

Cooling Mode

(kW)

Heating Mode:HC

(kW)

Outdoor air temp. °CDB	Indoor air temperature															
	18 °CDB		21 °CDB		23 °CDB		26 °CDB		27 °CDB		28 °CDB		31 °CDB		33 °CDB	
	12 °CWB		14 °CWB		16 °CWB		18 °CWB		19 °CWB		20 °CWB		22 °CWB		24 °CWB	
°CDB	TC	SHC	TC	SHC	TC	SHC	TC	SHC	TC	SHC	TC	SHC	TC	SHC	TC	SHC
-15							6.36	5.33	6.54	5.28	6.74	5.24	7.15	5.53	7.55	5.42
-10							6.36	5.33	6.54	5.28	6.74	5.24	7.15	5.53	7.55	5.42
-5							6.36	5.33	6.54	5.28	6.74	5.24	7.15	5.53	7.55	5.42
0					5.98	4.92	6.36	5.33	6.54	5.28	6.74	5.24	7.15	5.53	7.55	5.42
5					5.98	4.92	6.36	5.33	6.54	5.28	6.74	5.24	7.15	5.53	7.55	5.42
11					5.98	4.92	6.36	5.33	6.54	5.28	6.74	5.24	7.15	5.53	7.55	5.42
13					5.98	4.92	6.36	5.33	6.54	5.28	6.74	5.24	7.15	5.53	7.55	5.42
15					5.98	4.92	6.36	5.33	6.54	5.28	6.74	5.24	7.15	5.53	7.55	5.42
17					6.40	5.09	6.81	5.49	7.01	5.45	7.23	5.40	7.66	5.69	8.10	5.57
19					6.83	5.27	7.26	5.66	7.47	5.61	7.71	5.57	8.18	5.85	8.65	5.73
21					6.78	5.25	7.20	5.64	7.41	5.59	7.65	5.55	8.13	5.84	8.61	5.72
23					6.72	5.22	7.14	5.62	7.35	5.57	7.60	5.53	8.08	5.82	8.57	5.70
25			6.28	5.35	6.69	5.21	7.11	5.61	7.33	5.56	7.57	5.52	8.06	5.82	8.55	5.70
27			6.25	5.34	6.66	5.20	7.08	5.60	7.30	5.55	7.64	5.54	7.99	5.79		
29			6.11	5.28	6.53	5.14	6.99	5.56	7.25	5.53	7.55	5.51	7.86	5.75		
31			5.98	5.22	6.39	5.09	6.90	5.53	7.20	5.52	7.46	5.48	7.73	5.71		
33	5.52	4.82	5.78	5.14	6.26	5.03	6.81	5.50	7.15	5.50	7.37	5.45	7.60	5.67		
35	5.33	4.73	5.62	5.07	6.12	4.98	6.72	5.46	7.10	5.48	7.28	5.42	7.47	5.63		
37	5.20	4.67	5.48	5.01	5.96	4.91	6.50	5.38	6.85	5.39	7.05	5.34	7.26	5.57		
39	5.06	4.61	5.34	4.95	5.79	4.85	6.28	5.30	6.60	5.30	6.82	5.26	7.04	5.50		
41	4.93	4.55	5.20	4.89	5.62	4.78	6.06	5.22	6.34	5.21	6.59	5.19	6.83	5.44		
43	4.80	4.49	5.06	4.83	5.46	4.72	5.84	5.14	6.09	5.13	6.36	5.11	6.62	5.38		
46	4.60	4.40	4.85	4.74	5.21	4.62	5.52	5.03	5.71	5.00	6.01	5.00	6.31	5.28		
50	3.73	3.66	3.96	3.88	4.29	4.21	4.59	4.50	4.77	4.68	4.91	4.65	5.05	4.92		

Outdoor air temp.		Indoor air temperature					
°CDB	°CWB	°CDB					
		16	18	20	22	24	
-19.8	-20	4.55	4.48	4.40	4.33	4.25	
-17.7	-18	4.60	4.53	4.47	4.39	4.31	
-15.7	-16	5.12	5.04	4.96	4.88	4.80	
-13.5	-14	5.29	5.21	5.13	5.05	4.96	
-11.5	-12	5.63	5.55	5.46	5.38	5.29	
-9.5	-10	5.97	5.89	5.80	5.71	5.61	
-7.5	-8	6.32	6.22	6.13	6.03	5.94	
-5.5	-6	6.53	6.43	6.33	6.23	6.13	
-3.0	-4	6.74	6.63	6.53	6.43	6.32	
-1.0	-2	6.95	6.84	6.73	6.62	6.51	
1.0	0	7.16	7.04	6.93	6.82	6.71	
2.0	1	7.26	7.14	7.03	6.91	6.80	
3.0	2	7.42	7.32	7.22	7.11	6.99	
5.0	4	7.73	7.67	7.61	7.49	7.36	
7.0	6	8.05	8.02	8.00	7.87	7.74	
9.0	8	8.37	8.37	8.38	8.21	8.05	
11.5	10	8.69	8.72	8.76	8.56	8.35	
13.5	12	9.08	9.13	9.17	8.99	8.82	
15.5	14	9.48	9.53	9.58	9.43	9.28	
16.5	16	9.68	9.73	9.78	9.65	9.51	

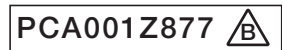

Notes(1) These data show average status.

Depending on the system control, there may be ranges where the operation is not conducted continuously.

These data show the case where the operation frequency of a compressor is fixed. (Cooling only)

In the heating mode in which the outside air temperature is 0°CDB or less, the compressor operates at maximum frequency.

(2) Capacities are based on the following conditions.

Corresponding refrigerant piping length :7.5m

Level difference of Zero.

(3) Symbols are as follows

TC :Total cooling capacity (kW)

SHC :Sensible heat capacity (kW)

HC :Heating capacity (kW)

[References data]

Capacity variation against outdoor and indoor temperature at the maximum compressor speed capacity compensation coefficient shows the ratio to nominal capacity.

Model FDC71VNX-W

① **Cooling**

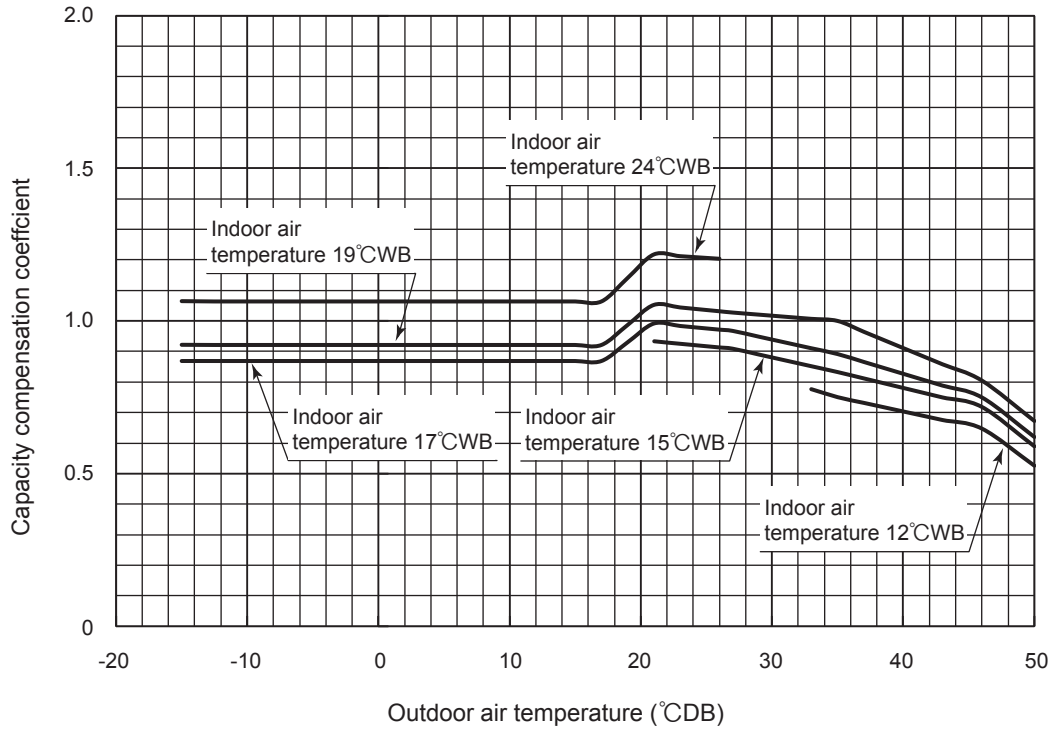

② **Heating**

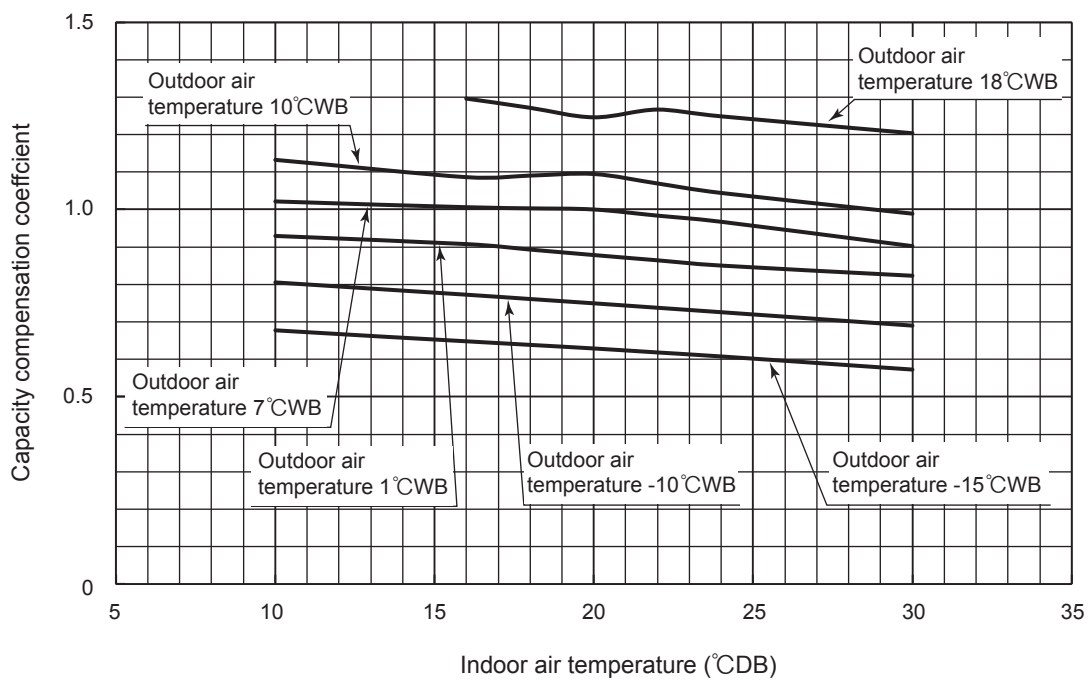

1.9.2 Correction of cooling and heating capacity in relation to air flow rate control (Fan speed)

Fan speed	P-Hi or Hi	Me	Lo
Coefficient	1.00	0.97	0.95

1.9.3 Correction of cooling and heating capacity in relation to one way length of refrigerant piping

It is necessary to correct the cooling and heating capacity in relation to the one way equivalent piping length between the indoor and outdoor units.

Equivalent piping length ⁽¹⁾(m)	7.5	10	15	20	25	30	35	40	45	50		
Heating	1	1	1	1	1	0.998	0.998	0.993	0.993	0.988		
Cooling	FDC71 model	φ 15.88	1	0.996	0.989	0.982	0.975	0.968	0.961	0.954	0.947	0.940

Note (1) Calculate the equivalent length using the following formula.

However, install the piping so that the piping length is within +5 m of the limit length (actual length) for the respective types.

- Equivalent length = Actual length + (Equivalent bend length x number of bends in the piping.)
Equivalent length per bend.

Gas pipe diameter (mm)	φ 15.88
Equivalent bend length	0.25

1.9.4 Height difference between the indoor unit and outdoor unit

When the outdoor unit is located below indoor units in cooling mode, or when the outdoor unit is located above indoor units in heating mode, the correction coefficient mentioned in the below table should be subtracted from the value in the above table.

Height difference between the indoor unit and outdoor unit in the vertical height difference	5m	10m	15m	20m	25m	30m
Adjustment coefficient	0.99	0.98	0.97	0.96	0.95	0.94

Piping length limitations

Model	FDC71
Item	
Max. one way piping length	50m
Max. vertical height difference	Outdoor unit is higher 30m Outdoor unit is lower 15m

Note (1) Values in the table indicate the one way piping length between the indoor and outdoor units.

How to obtain the cooling and heating capacity

Example : The net cooling capacity of the model FDT71VNXWPVH with the air flow “P-Hi”, the piping length of 15m, the outdoor unit located 5m lower than the indoor unit, indoor wet-bulb temperature at 19.0°C and outdoor dry-bulb temperature 35°C is

$$\text{Net cooling capacity} = \underset{\substack{\uparrow \\ \text{Net cooling total capacity of FDT71VNXWPVH} \\ \text{(Outdoor temp. : 35°CDB} \\ \text{Indoor temp. : 19°CWB)} \\ \text{shown in table 1.9.1}}}{7.1} \times \underset{\substack{\uparrow \\ \text{Air flow : P-Hi} \\ \text{shown in table 1.9.2}}}{1.00} \times \underset{\substack{\uparrow \\ \text{Piping length : 15m} \\ \text{(Gas pipe size is } \phi 15.88) \\ \text{shown in table 1.9.3}}}{0.989} \times \underset{\substack{\uparrow \\ \text{Height diff. : 5m} \\ \text{(Outdoor unit : below)} \\ \text{shown in table 1.9.4}}}{0.99} = 7.0\text{kW}$$



1.10 APPLICATION DATA

1.10.1 Installation of indoor unit (1) Ceiling cassette-4 way type(FDT)



PJF012D051

This manual is for the installation of the indoor unit. For electrical wiring work (Indoor unit), refer to page 91. For remote control installation, refer to page 95. For wireless kit installation, refer to page 141. For electrical wiring work (Outdoor unit) and refrigerant pipe work installation for outdoor unit, refer to page 107. For motion sensor kit installation, refer to page 173. This unit must always be used with the panel.





























SAFETY PRECAUTIONS

- Read the "SAFETY PRECAUTIONS" carefully first of all and then strictly follow it during the installation work in order to protect yourself.
- The precautionary items mentioned below are distinguished into two levels, **⚠️WARNING** and **⚠️CAUTION**.
⚠️WARNING: Wrong installation would cause serious consequences such as injuries or death.
⚠️CAUTION: Wrong installation might cause serious consequences depending on circumstances.
 Both mentions the important items to protect your health and safety so strictly follow them by any means.
- The meanings of "Marks" used here are as shown on the right:
 Never do it under any circumstances.  Always do it according to the instruction.
- After completing the installation, do commissioning to confirm there are no abnormalities, and explain to the customers about "SAFETY PRECAUTIONS", correct operation method and maintenance method (air filter cleaning, operation method and temperature setting method) with user's manual of this unit.
 Ask your customers to keep this installation manual together with the user's manual. Also, ask them to hand over the user's manual to the new user when the owner is changed.

⚠️ WARNING

- **Installation should be performed by the specialist.** 
 If you install the unit by yourself, it may lead to serious trouble such as water leakage, electric shock, fire, and injury due to overturn of the unit.
- **Install the system correctly according to these installation manuals.** 
 Improper installation may cause explosion, injury, water leakage, electric shock, and fire.
- **Check the density referred by the formula (accordance with ISO5149).** 
 If the density exceeds the limit density, please consult the dealer and installate the ventilation system.
- **Use the genuine accessories and the specified parts for installation.** 
 If parts unspecified by our company are used it could cause water leakage, electric shock, fire, and injury due to overturn of the unit.
- **Ventilate the working area well in case the refrigerant leaks during installation.** 
 If the refrigerant contacts the fire, toxic gas is produced.
 In case of R32, the refrigerant could be ignited because of its flammability.
- **Install the unit in a location that can hold heavy weight.** 
 Improper installation may cause the unit to fall leading to accidents.
- **Install the unit properly in order to be able to withstand strong winds such as typhoons, and earthquakes.** 
 Improper installation may cause the unit to fall leading to accidents.
- **Do not mix air in to the cooling cycle on installation or removal of the air-conditioner.** 
 If air is mixed in, the pressure in the cooling cycle will rise abnormally and may cause explosion and injuries.
- **Be sure to have the electrical wiring work done by qualified electrical installer, and use exclusive circuit.** 
 Power source with insufficient capacity and improper work can cause electric shock and fire.
- **Use specified wire for electrical wiring, fasten the wiring to the terminal securely, and hold the cable securely in order not to apply unexpected stress on the terminal.** 
 Loose connections or hold could result in abnormal heat generation or fire.
- **Arrange the electrical wires in the control box properly to prevent them from rising. Fit the lid of the services panel properly.** 
 Improper fitting may cause abnormal heat and fire.
- **Check for refrigerant gas leakage after installation is completed.** 
 If the refrigerant gas leaks into the house and comes in contact with a fan heater, a stove, or an oven, toxic gas is produced.
- **Use the specified pipe, flare nut, and tools for R32 or R410A.** 
 Using existing parts (R22) could cause the unit failure and serious accident due to explosion of the cooling cycle.
- **Tighten the flare nut according to the specified method by with torque wrench.** 
 If the flare nut were tightened with excess torque, it could cause burst and refrigerant leakage after a long period.
- **Do not put the drainage pipe directly into drainage channels where poisonous gases such as sulfide gas can occur.** 
 Poisonous gases will flow into the room through drainage pipe and seriously affect the user's health and safety. This can also cause the corrosion of the indoor unit and a resultant unit failure or refrigerant leak.
- **Connect the pipes for refrigeration circuit securely in installation work before compressor is operated.** 
 If the compressor is operated when the service valve is open without connecting the pipe, it could cause explosion and injuries due to abnormal high pressure in the system.
- **Stop the compressor before removing the pipe after shutting the service valve on pump down work.** 
 If the pipe is removed when the compressor is in operation with the service valve open, air would be mixed in the refrigeration circuit and it could cause explosion and injuries due to abnormal high pressure in the cooling cycle.
- **Only use prescribed option parts. The installation must be carried out by the qualified installer.** 
 If you install the system by yourself, it can cause serious trouble such as water leaks, electric shocks, fire.
- **Do not repair by yourself. And consult with the dealer about repair.** 
 Improper repair may cause water leakage, electric shock or fire.
- **Consult the dealer or a specialist about removal of the air-conditioner.** 
 Improper installation may cause water leakage, electric shock or fire.
- **Turn off the power source during servicing or inspection work.** 
 If the power is supplied during servicing or inspection work, it could cause electric shock and injury by the operating fan.
- **Do not run the unit when the panel or protection guard are taken off.** 
 Touching the rotating equipment, hot surface, or high voltage section could cause an injury to be caught in the machine, to get burned, or electric shock.
- **Shut off the power before electrical wiring work.** 
 It could cause electric shock, unit failure and improper running.

⚠️ CAUTION

- **Perform earth wiring surely.** 
 Do not connect the earth wiring to the gas pipe, water pipe, lightning rod and telephone earth wiring. Improper earth could cause unit failure and electric shock due to a short-circuit.
- **Earth leakage breaker must be installed.** 
 If the earth leakage breaker is not installed, it can cause electric shocks.
- **Use the circuit breaker of correct capacity. Circuit breaker should be the one that disconnect all poles under over current.** 
 Using the incorrect one could cause the system failure and fire.
- **Do not use any materials other than a fuse of correct capacity where a fuse should be used.** 
 Connecting the circuit by wire or copper wire could cause unit failure and fire.
- **Do not install the indoor unit near the location where there is possibility of flammable gas leakages.** 
 If the gas leaks and gathers around the unit, it could cause fire.
- **Do not install and use the unit where corrosive gas (such as sulfuric acid gas etc.) or flammable gas (such as thinner, petroleum etc.) may be generated or accumulated, or volatile flammable substances are handled.** 
 It could cause the corrosion of heat exchanger, breakage of plastic parts etc. And inflammable gas could cause fire.
- **Secure a space for installation, inspection and maintenance specified in the manual.** 
 Insufficient space can result in accident such as personal injury due to falling from the installation place.
- **Do not use the indoor unit at the place where water splashes such as laundry.** 
 Indoor unit is not waterproof. It could cause electric shock and fire.
- **Do not use the indoor unit for a special purpose such as food storage, cooling for precision instrument, preservation of animals, plants, and a work of art.** 
 It could cause the damage of the items.
- **Do not install nor use the system near equipments which generate electromagnetic wave or high harmonics.** 
 Equipments like inverter equipment, private power generator, high-frequency medical equipment, or telecommunication equipment might influence the air-conditioner and cause a malfunction and breakdown. Or the air conditioner might influence medical equipments or telecommunication equipments, and obstruct their medical activity or cause jamming.
- **Do not install the remote control at the direct sunlight.** 
 It could cause breakdown or deformation of the remote control.
- **Do not install the indoor unit at the place listed below.** 
 - Places where flammable gas could leak.
 - Places where carbon fiber, metal powder or any powder is floated.
 - Place where the substances which affect the air conditioner are generated such as sulfide gas, chloride gas, acid, alkali or ammoniac atmospheres.
 - Places exposed to oil mist or steam directly.
 - On vehicles and ships
 - Places where machinery which generates high harmonics is used.
 - Places where cosmetics or special sprays are frequently used.
 - Highly salted area such as beach.
 - Heavy snow area
 - Places where the system is affected by smoke from a chimney.
 - Altitude over 1000m
- **Do not install the indoor unit in the locations listed below (Be sure to install the indoor unit according to the installation manual for each model because each indoor unit has each limitation)** 
 - Locations with any obstacles which can prevent inlet and outlet air of the unit
 - Locations where vibration can be amplified due to insufficient strength of structure.
 - Locations where the infrared receiver is exposed to the direct sunlight or the strong light beam. (In case of the infrared specification unit)
 - Locations where an equipment affected by high harmonics is placed. (TV set or radio receiver is placed within 5m)
 - Locations where drainage cannot run off safely. It can affect performance or function and etc.
 - Do not install the motion sensor mounting panel at following places. It could cause detection error, incapacity of detection, or characteristic degradation.
 - Place where vibration is applied to it for a long period of time.
 - Place where static electricity or electromagnetic wave generates.
 - Place where it is exposed to high temperature or humidity for a long period of time.
 - Dusty place or where the lens face could be fouled or damaged.
- **Do not put any valuables which will break down by getting wet under the air-conditioner.** 
 Condensation could drop when the relative humidity is higher than 80% or drain pipe is clogged, and it damages user's belongings.
- **Do not use the base frame for the outdoor unit which is corroded or damaged after a long period of use.** 
 It could cause the unit falling down and injury.
- **Pay attention not to damage the drain pan by weld sputter when brazing work is done near the unit.** 
 If sputter entered into the unit during brazing work, it could cause damage (pinhole) of drain pan and leakage of water. To avoid damaging, keep the indoor unit packed or cover the indoor unit.
- **Install the drain pipe to drain the water surely according to the installation manual.** 
 Improper connection of the drain pipe may cause dropping water into room and damaging user's belongings.
- **Be sure to perform air tightness test by pressurizing with nitrogen gas after completed refrigerant piping work.** 
 If the density of refrigerant exceeds the limit in the event of refrigerant leakage in the small room, lack of oxygen can occur, which can cause serious accidents.
- **For drain pipe installation, be sure to make descending slope of greater than 1/100, not to make traps, and not to make air-bleeding.** 
 Check if the drainage is correctly done during commissioning and ensure the space for inspection and maintenance.
- **Ensure the insulation on the pipes for refrigeration circuit so as not to condense water.** 
 Incomplete insulation could cause condensation and it would wet ceiling, floor, and any other valuables.
- **Do not install the outdoor unit where is likely to be a nest for insects and small animals.** 
 Insects and small animals could come into the electronic components and cause breakdown and fire. Instruct the user to keep the surroundings clean.
- **Pay extra attention, carrying the unit by hand.** 
 Carry the unit with 2 people if it is heavier than 20kg. Do not use the plastic straps but the grabbing place, moving the unit by hand. Use protective gloves in order to avoid injury by the aluminum fin.
- **Make sure to dispose of the packaging material.** 
 Leaving the materials may cause injury as metals like nail and woods are used in the package.
- **Do not operate the system without the air filter.** 
 It may cause the breakdown of the system due to clogging of the heat exchanger.
- **Do not touch any button with wet hands.** 
 It could cause electric shock.
- **Do not touch the refrigerant piping with bare hands when in operation.** 
 The pipe during operation would become very hot or cold according to the operating condition, and it could cause a burn or frostbite.
- **Do not clean up the air-conditioner with water.** 
 It could cause electric shock.
- **Do not turn off the power source immediately after stopping the operation.** 
 Be sure to wait for more than 5 minutes. Otherwise it could cause water leakage or breakdown.
- **Do not control the operation with the circuit breaker.** 
 It could cause fire or water leakage. In addition, the fan may start operation unexpectedly and it may cause injury.

① Before installation

- Install correctly according to the installation manual.
- Confirm the following points:
 - Unit type/Power source specification
 - Pipes/Wires/Small parts
 - Accessory items

When moving the indoor unit, hold only the hanging hardware (4 places) only, with care not to apply forces to any other parts of the unit (particularly the refrigerant pipe, drain pipe, and resin parts).

Accessory item

For unit hanging		For refrigerant pipe			For drain pipe			
Flat washer (M10)	Level gauge	Pipe cover(big)	Pipe cover (small)	Strap	Pipe cover(big)	Pipe cover(small)	Drain hose	Hose clamp
8	1	1	1	4	1	1	1	1
For unit hanging	For height adjustment and level gauge	For heat insulation of gas pipe	For heat insulation of liquid tube	For pipe cover fixing	For heat insulation of drain socket	For heat insulation of drain socket	For drain pipe connecting	For drain hose mounting

② Selection of installation location for the indoor unit

- Select the suitable areas to install the unit under approval of the user.
 - Areas where the indoor unit can deliver hot and cold wind sufficiently. Suggest to the user to use a circulator if the ceiling height is over 3m to avoid warm air being accumulated on the ceiling.
 - In case of the panel having the motion sensor, the installation height must be no higher than 4 m. It could reduce the sensitivity of motion sensor, disabling the detection.
 - Areas where there is enough space to install and service.
 - Areas where it can be drained properly. Areas where drain pipe descending slope can be taken.
 - Areas where there is no obstruction of air flow on both air return grille and air supply port.
 - Areas where fire alarm will not be accidentally activated by the air-conditioner.
 - Areas where the supply air does not short-circuit.
 - Areas where it is not influenced by draft air.
 - Areas not exposed to direct sunlight.
 - Areas where dew point is lower than around 28°C and relative humidity is lower than 80%.

This indoor unit is tested under the condition of JIS (Japan Industrial Standard) high humidity condition and confirmed there is no problem. However, there is some risk of condensation drop if the air conditioner is operated under the severer condition than mentioned above.

If there is a possibility to use it under such a condition, attach additional insulation of 10 to 20mm thick for entire surface of indoor unit, refrigeration pipe and drain pipe.

 - Areas where TV and radio stays away more than 1m. (It could cause jamming and noise.)
 - Areas where any items which will be damaged by getting wet are not placed such as food, table wares, server, or medical equipment under the unit.
 - Areas where there is no influence by the heat which cookware generates.
 - Areas where not exposed to oil mist, powder and/or steam directly such as above fryer.
 - Areas where lighting device such as fluorescent light or incandescent light doesn't affect the operation.

(A beam from lighting device sometimes affects the infrared receiver for the wireless remote control and the air-conditioner might not work properly.)

- Check if the place where the air-conditioner is installed can hold the weight of the unit. If it is not able to hold, reinforce the structure with boards and beams strong enough to hold it. If the strength is not enough, it could cause injury due to unit falling.
- If there are 2 units of wireless type, keep them away for more than 6m to avoid malfunction due to cross communication.
- When plural indoor units are installed nearby, keep them away for more than 4 to 5m.

Space for installation and service

- When it is not possible to keep enough space between indoor unit and wall or between indoor units, close the air supply port where it is not possible to keep space and confirm there is no short-circuit of air flow.
- Install the indoor unit at a height of more than 2.5m above the floor.

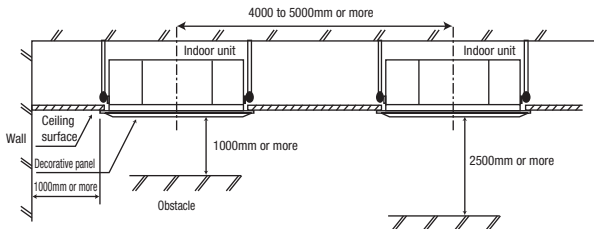

Set blow-out pattern

- Select the most proper number of blow-out air supply port direction from 4 way, 3 way or 2 way according to the shape of the room and installation position. (1 way is not available.)
- If it is necessary to change the number of air supply port, prepare the covering materials. (sold as accessory)
- Instruct the user not to use low fan speed when 2 way or 3 way air supply is used.
- Do not use 2 way air supply port under high temperature and humidity environment. (Otherwise it could cause condensation and leakage of water.)
- It is possible to set the air flow direction port by port independently. Refer to the user's manual for details.

③ Preparation before installation

- If suspension bolt becomes longer, do reinforcement of earthquake resistant.
 - For grid ceiling
 - When suspension bolt length is over 500mm, or the gap between the ceiling and roof is over 700mm, apply earthquake resistant brace to the bolt.
 - In case the unit is hung directly from the slab and is installed on the ceiling plane which has enough strength.
 - When suspension bolt length is over 1000mm, apply the earthquake resistant brace to the bolt.
- Prepare four (4) sets of suspension bolt, nut and spring washer (M10 or M8) on site.

Ceiling opening, Suspension bolts pitch, Pipe position

※It is possible the suspension bolts pitch to adjust according to the this table.

Type	Mark	P1	P2
1		770	725-770
2		770-800	725

Series	Type	a	d	f	g	h
Single Split (PAC) series	40 to 71 type	236	37	105	88	67
	100 to 140 type	298	99	167	140	129
VRF (KX) series	28 to 71 type	236	37	105	88	67
	90 to 160 type	298	99	167	140	129

Symbol	
A	Gas piping
B	Liquid piping
C	Drain piping
D	Hole for wiring
F	Suspension bolts
G	Outside air opening for ducting
H1	Air outlet opening for ducting
H2	Air outlet opening for ducting

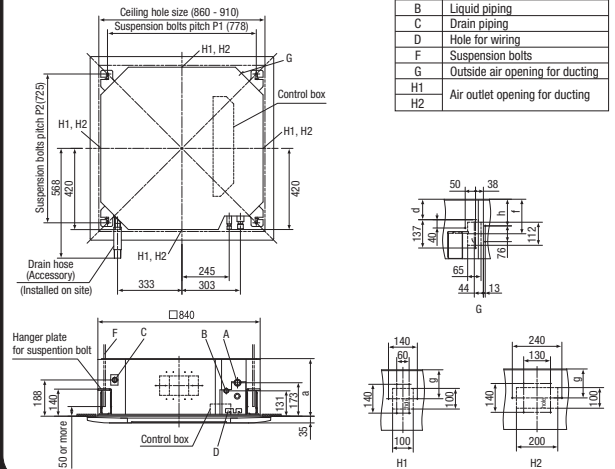

④ Installation of indoor unit

Work procedure

- Set the suspension bolt length to about 50 mm from the ceiling.
- Temporarily locate the lower nuts of the suspension bolts (4 places) at a position approximately 150 mm from the ceiling.
- Temporarily locate the upper nuts of the suspension bolts (4 places) at positions sufficiently distance from the lower nuts so that they do not interfere with the suspension of the indoor unit and with its height adjustment.
- Set the upper nuts of the suspension bolts and upper washers (4 places) at positions sufficiently distance from the lower nuts. Then, push and insert the temporary fixing carton of washers (*1) onto suspension bolts. Make sure that the upper washers do not slide down.
- Suspend the indoor unit.
- After suspending the indoor unit, mount the level gauge (*2) to the air outlet of the indoor unit, and adjust the suspension height of the indoor unit. Loosen the upper nuts (4 places), and adjust the suspension height using the lower nuts (4 places). Confirm there is no slack between the lower nuts and flat washers of the indoor unit hanger plate (4 places).
- Remove the temporary fixing carton of washers (from all 4 places).
- Make sure that the indoor unit is installed horizontally. Confirm the levelness of the indoor unit using a level gauge or transparent hose filled with water. (Keep the height difference at both ends of the indoor unit within 3 mm.)
- Tighten the upper nuts of the suspension bolts (4 places).

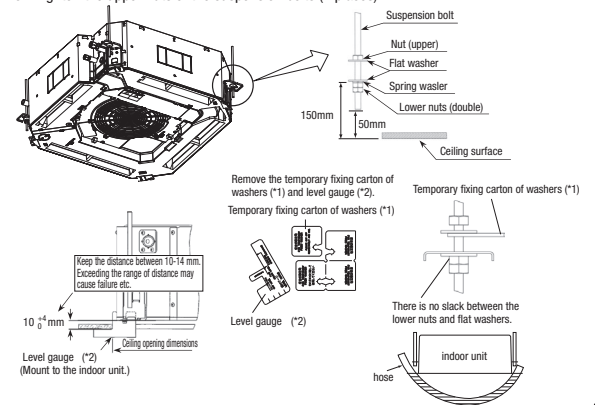

④ Installation of indoor unit (continued)

Protection of the indoor unit

- If it is not possible to install the panel for a while or if attaching the ceiling board after installing the indoor unit, protect the indoor unit by using upper carton.

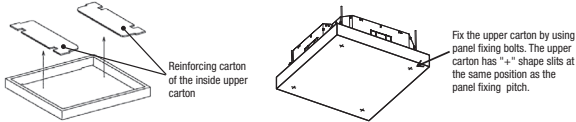

Caution

- Do not adjust the unit height by adjusting the upper nuts. Doing so will cause unexpected stress on the indoor unit and cause the unit to become deformed, prevent the panel from being installed, and be generated fan interference noise.
- Make sure that the indoor unit is installed horizontally and set the appropriate gap between the underside of the unit and the ceiling plane. Improper installation may cause air leakage, dew condensation, water leakage and noise.
- Even after the panel has been installed, the unit height can still be finely adjusted. Refer to the panel installation manual for details.
- Make sure there is no gap between the panel and the ceiling surface, and between the panel and the indoor unit. Any gap may cause air and/or water to leak, or condensation to form.

⑤ Refrigerant pipe

Caution

- Be sure to use new pipes for the refrigerant pipes. Use the flare nut attached to the product. Regarding whether existing pipes can be reused or not, and the washing method, refer to the instruction manual of the outdoor unit, catalogue or technical data.
 - 1) In case of reuse: Do not use old flare nut, but use the nut attached to the unit.
 - 2) In case of reuse: Flare the end of pipe replaced partially for R32 or R410A.

⚠️ **WARNING** : When flared joints are reused indoors, the flare part shall be re-fabricated. (only for R32)

Pipe dia. d mm	Min. pipe wall thickness mm	Protruding dimension for flare, mm		Flare O.D. D mm	Flare nut tightening torque N·m
		Rigid (Clutch type) For R32 For R410A	Conventional tool		
6.35	0.8	0 - 0.5	0.7 - 1.3	8.9 - 9.1	14 - 18
9.52	0.8			12.8 - 13.2	34 - 42
12.7	0.8			16.2 - 16.6	49 - 61
15.88	1			19.3 - 19.7	68 - 82
19.05	1.2			23.6 - 24.0	100 - 120

- Use phosphorus deoxidized copper alloy seamless pipe (C1220T) for refrigeration pipe installation. In addition, make sure there is no damage both inside and outside of the pipe, and no harmful substances such as sulfur, oxide, dust or a contaminant stuck on the pipes.
- Do not use any refrigerant other than the designated refrigerant. Using other refrigerant except the designated refrigerant, may degrade inside refrigeration oil. And air getting into refrigeration circuit may cause over-pressure and resultant it may result in bursting, etc.
- Store the copper pipes indoors and seal the both end of them until they are brazed in order to avoid any dust, dirt or water getting into pipe. Otherwise it will cause degradation of refrigeration oil and compressor breakdown, etc.
- Use special tools for R32 or R410A refrigerant.

Work procedure

1. Remove the flare nut and blind flanges on the pipe of the indoor unit.
 - ※ Make sure to loosen the flare nut with holding the nut on pipe side with a spanner and giving torque to the nut with another spanner in order to avoid unexpected stress to the copper pipe, and then remove them. (Gas may come out at this time, but it is not abnormal.)
 - Pay attention whether the flare nut pops out. (as the indoor unit is sometimes pressured.)
2. Make a flare on liquid pipe and gas pipe, and connect the refrigeration pipes on the indoor unit.
 - ※ Bend radius of pipe must be 4D or larger. Once a pipe is bent, do not readjust the bending. Do not twist a pipe or collapse to 2/3D or smaller.
 - Make sure to use flare nuts assembled on the unions. Usage of other flare nuts could cause refrigerant leakage.
 - ※ Do a flare connection as follows:
 - Make sure to hold the nut on indoor unit pipe side using double spanner method as indicated when fastening / loosening flare nuts in order to prevent unintentional twisting of the copper pipe.
 - When fastening the flare nut, align the refrigeration pipe with the center of flare nut, screw the nut for 3-4 times by hand and then tighten it by spanner with the specified torque mentioned in the table above.
3. Cover the flare connection part of the indoor unit with attached insulation material after a gas leakage inspection, and tighten both ends with attached straps.
 - Make sure to insulate both gas pipes and liquid pipes completely.
 - ※ Incomplete insulation may cause dew condensation or water dropping.
 - Use heat-resistant (120 °C or more) insulations on the gas side pipes.
 - In case of using at high humidity condition, reinforce insulation of refrigerant pipes. Surface of insulation may cause dew condition or water dropping, if insulations are not reinforced.
4. Refrigerant is charged in the outdoor unit. As for the additional refrigerant charge for the indoor unit and piping, refer to the installation manual attached to the outdoor unit.

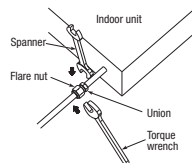

⑤ Refrigerant pipe (continued)

Caution:

Refrigerating machine oil should not be applied to the threads of union or external surface of flare. It is because, even if the same tightening torque is applied, the oil is likely to decrease the slide friction force on the threads and increase, in turn, the axial component force so that it could crack the flare by the stress corrosion. Refrigerating machine oil may be applied to the internal surface of flare only.

<The case of using thickness of insulation is 10mm>

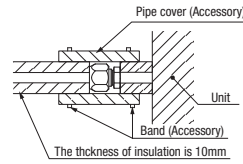

<The case of using reinforced insulation>

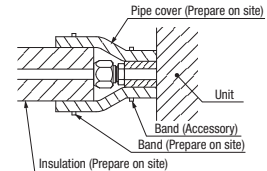

⑥ Drain pipe

Caution

- Install the drain pipe according to the installation manual in order to drain properly. Imperfection in draining may cause flood indoors and wetting the household goods, etc.
- Do not put the drain pipe directly into the ditch where toxic gas such as sulfur, the other harmful and inflammable gas is generated. Toxic gas would flow into the room and it would cause serious damage to user's health and safety (some poisoning or deficiency of oxygen). In addition, it may cause corrosion of heat exchanger and bad smell.
- Connect the pipe securely to avoid water leakage from the joint.
- Insulate the pipe properly to avoid condensation drop.
- Check if the water can flow out properly from both the drain outlet on the indoor unit and the end of the drain pipe after installation.
- Make sure to make descending slope of greater than 1/100 and do not make up-down bend and/or trap in the midway. In addition, do not put air vent on the drain pipe. Check if water is drained out properly from the pipe during commissioning. Also, keep sufficient space for inspection and maintenance.

Work procedure

1. Make sure that the drain hose (the soft PVC side) is inserted into the end of the step part of the drain socket. Fix the hose clamp so that its bolt is located on the outside of the indoor unit, and the bolt are fastened in a vertical orientation.
 - Do not apply adhesives on this end.
2. Position the hose clamp so that it touches the insulation of the drain hose, and then tighten the bolt.
3. Turn the bolt several times until it is securely tightened, but do not tighten it excessively.

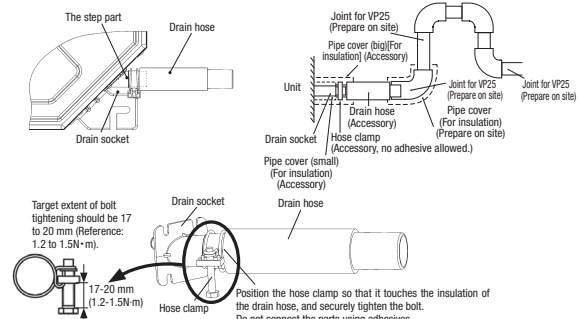

4. Prepare a joint for connecting VP25 pipe, adhere and connect the joint to the drain hose (the rigid PVC side), and adhere and connect VP25 pipe (prepare on site).
 - ※ As for drain pipe, apply VP25 made of rigid PVC which is on the market.
 - Make sure that the adhesive will not get into the supplied drain hose. It may cause the flexible part broken after the adhesive is dried up and gets rigid.
 - The flexible drain hose is intended to absorb a small difference at installation of the unit or drain pipes. Intentional bending, expanding may cause the flexible hose broken and water leakage.
 - As for drain pipe, apply VP25 (OD32). If apply PVC25 (OD25), connect the expanded connector to the drain hose, with adhesive. (Multi unit only)

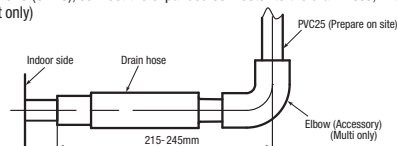

5. Make sure to make descending slope of greater than 1/100 and do not make up-down bend and/or trap in the midway.
 - Pay attention not to give stress on the pipe on the indoor unit side, and support and fix the pipe as close place to the unit as possible when connecting the drain pipe.
 - Do not set up air vent.

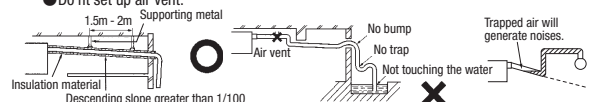

⑥ Drain pipe (continued)

- When sharing a drain pipe for more than 1 unit, lay the main pipe 100mm below the drain outlet of the unit. In addition, select VP30 or bigger size for main drain pipe.

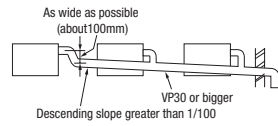

6. Insulate the drain pipe.

- Be sure to insulate the drain socket and rigid PVC pipe installed indoors otherwise it may cause dew condensation and water leakage.
- ※ After drainage test implementation, cover the drain socket part with pipe cover (small size), then use the pipe cover (big size) to cover the pipe cover (small size), clamps and part of the drain hose, and fix and wrap it with tapes to wrap and make joint part gapless.

Drain up

- The position for drain pipe outlet can be raised up to 850mm above the ceiling. Use elbows for installation to avoid obstacles inside ceiling. If the horizontal drain pipe is too long before vertical pipe, the backflow of water will increase when the unit is stopped, and it may cause overflow of water from the drain pan on the indoor unit. In order to avoid overflow, keep the horizontal pipe length and offset of the pipe within the limit shown in the figure below.

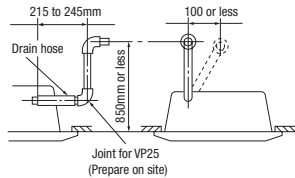

Drain test

- After installing the drain pipe, make sure that drain system works correctly and that no water leaks from the joint and drain pan. Check whether the motor sound of the drain pump is normal.
 - Conduct a drain test when installing, even during the heating season.
 - In the case of new buildings, be sure to complete the test before fixing the ceiling.
1. Pour about 1,000 cc of test water into the drain pan of the indoor unit. Exercise care not to allow electrical equipment such as the drain pump and other components to become wet while filling water. Pour test water through the pouring port of the pipe lid using a feed water pump or a similar device, or through the refrigerant pipe joint.

- In case of pouring water from the air outlet
- In case of pouring water from the pouring port of the pipe lid

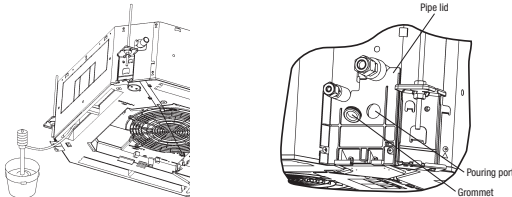

2. Make sure that water drains out completely and that no water leaks from any joints of the drain pipe during the test. Test to confirm that the water drains out correctly while listening to the drain pump motor operating sound. At the drain socket (transparent), it is possible to check whether the water drains out correctly.
3. Unplug the rubber plug on the indoor unit so that the remaining water drains from the drain pan after the draining test. After checking the water drainage, fix the rubber plug correctly. Installation work for the drain pipe must be performed for the entire drain pipe up to the indoor unit. If the pipe lid has been removed in order to pour water, mount the pipe lid again.

Drain pump operation

- In case electrical wiring work completed
Drain pump can be operated by the wired remote control. For the operation method, refer to [Operation for drain pump] in the installation manual for wiring work.
- In case electrical wiring work not completed
Drain pump will run continuously when the dip switch "SW7-1" on the indoor unit PCB is turned ON, the connector CnB is disconnected, and then the power source (230VAC on the terminal block ①) and ②) is turned ON. Make sure to turn OFF "SW7-1" and reconnect the connector CnB after the test.

⑦ Wiring-out position and wiring connection

- Electrical installation work must be performed according to the installation manual by an electrical installation service provider qualified by a power provider of the country, and be executed according to the technical standards and other regulations applicable to electrical installation in the country.

- Be sure to use an exclusive circuit.
- Use specified cord, fasten the wiring to the terminal securely, and hold the cord securely in order not to apply unexpected stress on the terminal.
- Do not put both power source line and signal line on the same route. It may cause miscommunication and malfunction.
- Be sure to do D type earth work.
- For the details of electrical wiring work, see attached instruction manual for electrical wiring work.

1. Loosen the 2 screws of the lid of the control box, and slide the lid in the direction of the arrow shown in the figure. It will then be possible to open the lid.

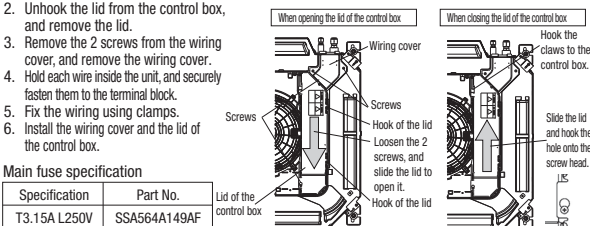

Main fuse specification

Specification	Part No.
T3.15A L250V	SSA564A149AF

⑦ Wiring-out position and wiring connection (continued)

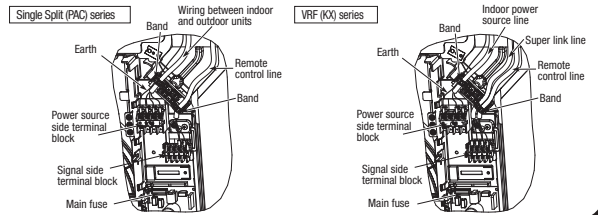

⑧ Panel installation

- Install the panel on the indoor unit after electrical wiring work.
- Refer to the attached manual for panel installation for details.

⑨ Check list after installation

- Check the following items after all installation work completed.

Check if,	Expected trouble	Check
The indoor and outdoor units are fixed securely?	Falling, vibration, noise	
Inspection for leakage is done?	Insufficient capacity	
Insulation work is properly done?	Water leakage	
Water is drained properly?	Water leakage	
Power source voltage is same as mentioned in the model name plate?	PCB burnt out, not working at all	
There is mis-wiring or mis-connection of piping?	PCB burnt out, not working at all	
Earth wiring is connected properly?	Electric shock	
Cable size comply with specified size?	PCB burnt out, not working at all	
Any obstacle blocks air flow on air inlet and outlet?	Insufficient capacity	

⑩ How to check the dirt of drain pan and cleaning the inlet of the drain pump. (Maintenance)

The method of checking the dirt of drain pan

- It is possible to check dirt on the drain pan and drain pump inlet without removing the panel.
1. Open the inlet grille and remove the corner lid on the drain pan side.
 2. Remove the drain cap cover (1 screw) from the panel corner.
 3. Check the dirt on the drain pan from the drain cap, and check the drain pump inlet. If the drain pan is very dirty, remove the drain pan and clean it.
 4. After checking, refix the drain cap cover securely.

- If the cover is not refixed correctly, it may cause condensation to form and/or water to leak.

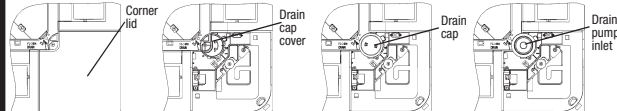

Cleaning of drain pump inlet

- It is possible to clean the drain pump inlet and surrounding area by removing the drain cap only; it is not necessary to remove the panel and drain pan.

- Before removing the drain cap, remove the rubber plug and drain water from the drain pan.
1. Remove the drain cap cover as described above.
 2. Insert the nose of the pliers into the concave portions (2 places) of the drain cap, and rotate the pliers about 1 turn in the CW direction. The drain cap is removed.
 3. When cleaning the drain pump inlet, use a soft plastic tool. If a metallic tool is used, the drain cap mounting portion may be scratched and water may leak.
 4. Before mounting the drain cap, rinse it and **remove any foreign material from the inside of the cap**. If the drain cap is installed with foreign material inside it, it may cause water to leak.
 5. Insert the nose of the pliers into the concave portions of the drain cap and rotate the pliers to install the drain cap. Rotate the drain cap about 1 turn in the CW direction until it stops rotating. If the drain cap is not rotated for 1 or more turns, the cap will not have been installed correctly. Remove the drain cap, and then install it again correctly.
 6. After tightening the drain cap, make sure the triangle (Δ) mark of the drain cap comes close to the triangle mark on the panel. If these triangle marks are not close to each other, tighten the drain cap further.
 7. Refix the drain cap cover and rubber plug securely. If the cover is not refixed correctly, it may cause condensation to form and/or water to leak.

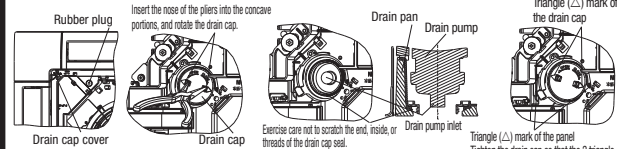

Notes for removing the drain pan

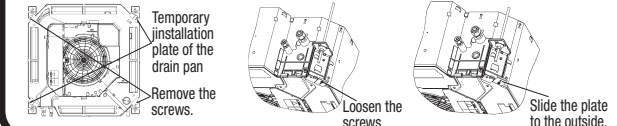

- Before removing the drain pan, drain water from the drain pan. Remove the rubber plug and drain water.
- The drain pan is installed by the temporary installation plate. Remove the 2 drain pan fixing screws, and loosen the 2 screws of the temporary installation plate. Slide the temporary installation plate to the outside of the drain pan. And then, it is possible to remove the drain pan.
- When reinstalling the drain pan, slide the temporary installation plate to the inside and temporarily fix the drain pan. Then, tighten the 2 drain pan fixing screws and the 2 screws of the temporary installation plate. Also, refix the rubber plug securely.



• Panel installation

Read this manual together with the indoor unit's installation manual.

⚠ WARNING

- **Fasten the wiring to the terminal securely and hold the cable securely so as not to apply unexpected stress on the terminal. Loose connection or hold will cause abnormal heat generation or fire.** 
- **Make sure the power source is turned off when electric wiring work. Otherwise, electric shock, malfunction and improper running may occur.** 



Function

The Anti draft panel has the anti draft mechanism. If the Anti draft panel is installed and the anti draft function is set, the anti draft function will be operated and reduce the draft feeling. (Refer to **⑥ Panel setting** for details.)

- Standard panel : without the anti draft mechanism
- Anti draft panel : with the anti draft mechanism

① Before installation

- Follow installation manual carefully, and install the panel properly.
- Check the following items.
- Accessories

Accessories		
	4 pieces	For panel installation
	4 pieces	For avoiding the corner panel from falling
	4 pieces	For fixing the corner panel

Note: Accessories are laid in the position removing the corner lid.

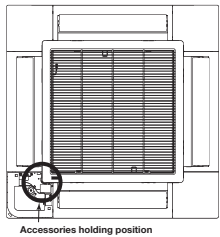

② Checking the indoor unit installation position

- Read this manual together with the air-conditioner installation manual carefully.
- Check if the opening size for the indoor unit is correct with the level gauge supplied in the indoor unit.
- Check if the gap between the plane and the indoor unit is correct by inserting the level gauge into the air outlet port of the indoor unit. (See below drawing)
- Adjust the installation elevation if necessary.
- Remove the level gauge before installing the panel.

Caution

If there is a height difference beyond the design limit between the installation level of the indoor unit and the panel, the panel may be subject to excessive stress during installation and it may cause distortion and damage.

The installation level of the indoor unit can be adjusted finely from the opening provided on the corner, even after panel is installed. (Refer to **④ Installing the panel** for details.)

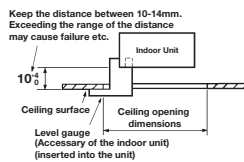

③ Removing the inlet grille

1. Hold the stoppers on the inlet grille (2 places) toward OPEN direction, open the inlet grille.
2. Remove the hooks of the inlet grille from the panel while it is in the open position.

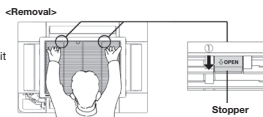

④ Removing the corner lid

- Pull the corner lid toward the direction indicated by the arrow and remove it. (Same way for all 4 corner lids)

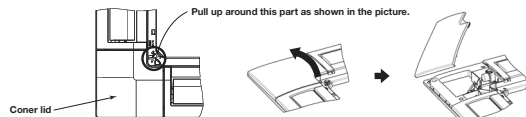

⑤ Orientation of the panel installation

- Take note that there is an orientation to install the panel.
- Install the panel with the orientation shown on the right.
 - Align the "PIPE SIDE" mark (on the panel) with the refrigerant pipes on the indoor unit.
 - Align the "DRAIN" mark (on the panel) with the drain pipe on the indoor unit.

CAUTION

In case the orientation of the panel is not correct, it will lead to air leakage and also it is not possible to connect the flap motor wiring.

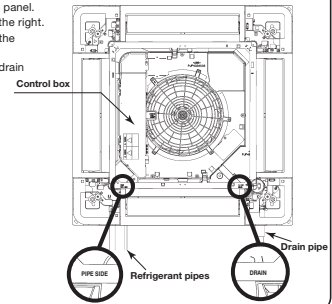

⑥ Installing the panel

1. Temporary hanging
 - Lift up the hanger (2 places) on the panel for temporary support.
 - Hang the panel on the hook on the indoor unit.

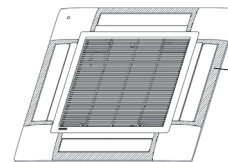
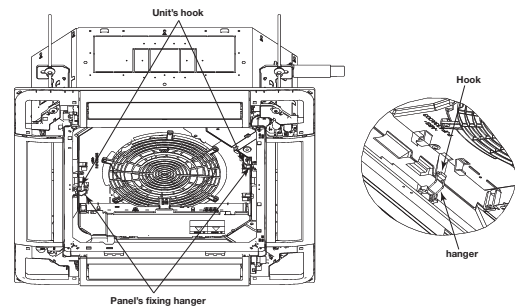

The Anti draft panel moves the parts of the anti draft mechanism (shaded area, 4 places). Note that they may break if they are moved forcibly by hand. Although the parts (shaded area) of the Standard panel are separate parts from the body, they do not move.

Caution

The parts (shaded area), of the anti draft mechanism around the air outlet, are separate parts. Handle the panel with care. Especially, the shaded area of the Anti draft panel move. Note that they may break if they are moved forcibly by hand.

2. Fix the panel on the indoor unit
 - Fasten the panel on the indoor unit with the 4 bolts supplied with the panel.

Caution

Improperly tightened fixing bolts cause the problems listed below, so make sure that bolts are securely tightened.

- If there is a gap between the ceiling and the panel even after the fixing bolts are tightened, adjust the installation level of the indoor unit again.

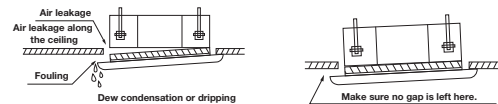

- It is possible to adjust the installation height of the indoor unit with the panel installed as long as there is no influence on the drain pipe inclination and/or the indoor unit levelness.

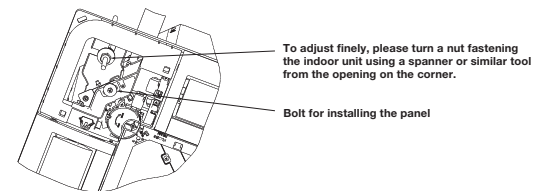

To adjust finely, please turn a nut fastening the indoor unit using a spanner or similar tool from the opening on the corner.

Caution

Do not give any stress on the panel when adjusting the height of the indoor unit to avoid unexpected distortion. It may cause the distortion of panel or failing to close the inlet grille, and the parts of the anti draft mechanism.

⑦ Electrical wiring

The wiring work varies depending on the panel type. Select the wiring work appropriate for the panel type. The connection positions of the indoor unit are as shown below irrespective of the panel type.

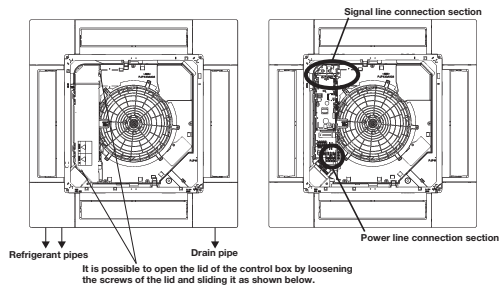

<For the Standard panel>

1. Loosen 2 screws on the control box lid of the indoor unit, and remove the lid by sliding it.
2. Pass the flap motor wiring (20-wire) through the hook of the control box, and connect to CnJ1 (20P, white).
3. Fix the control box lid of the indoor unit, and tighten 2 screws.

For the Standard panel
Signal line connection section

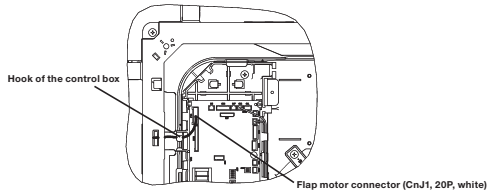

<For the Anti draft panel>

1. Loosen 2 screws on the control box lid of the indoor unit, and remove the lid by sliding it.
2. Pass the flap motor cable (20-wire) through the hook of the control box, and connect to CnJ1 (20P, white).
3. Pass the anti draft motor cable (20-wire) through the hook of the control box, and connect to CnJ2 (20P, white).
4. Fix the control box lid of the indoor unit, and tighten the 2 screws.

For the Anti draft panel
Signal line connection section

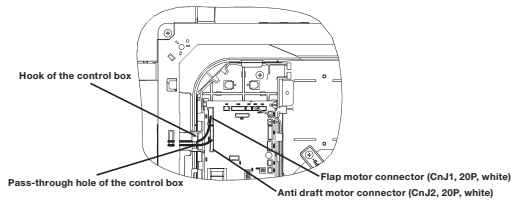

⑧ Installing a corner lid

1. To avoid unexpected falling of the corner lid, put the strap onto the corner lid's pin with turning the strap up.
2. Then hang the strap of a corner lid onto the panel's pin.
3. First insert the part "a" of a corner lid into the part "A" of the panel, and then engage 2 hooks.
4. Fix with screw.

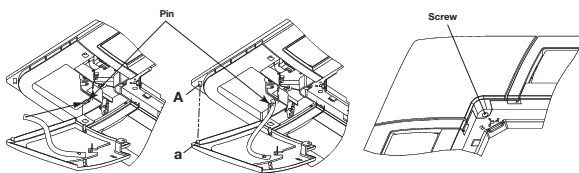

⑨ Installing the inlet grille

To attach the inlet grille, follow the procedure described in ⑧ **Removing the inlet grille** in the reverse order.

1. Hang the hooks of the inlet grille in the hole of the panel. (The hooks of the grille can be hanged in 4 side of the panel as following.)
2. After the grille is hanged, close the grille while the stoppers(2 places) on the grille are kept pressed to "OPEN" direction. When the grille comes to the original position, release the stoppers to hold the grille. Make sure to hear the sound of "CLICK" in both stoppers.

<Installation>

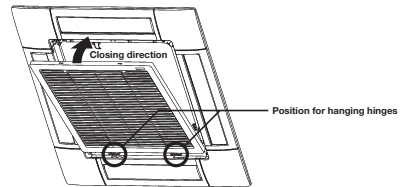

Caution

- Installing the inlet grille from the hinge side.
- Be careful in the inlet grille installing, unstable installing may cause grille falling.
- Repair or replace the distorted, broken stopper at once, or the grille falling may occur.

⑩ Panel setting

<Flap swing range setting (Individual flap control setting)>

It is possible to change the swing range of the flap by the wired remote control. Once the upper and lower limit positions are set, the flap will swing within the set range. It is also possible to set the different range to each flap.

<Anti draft setting>

The anti draft function will not be operated if the anti draft panel is installed and its wirings are only connected. To operate the anti draft function, enable the anti draft setting by using the wired or wireless remote control.

Note: It is not possible to set by the following remote control models or older.

- Wired: RC-EX1A, RC-E5, RCH-E3
- Wireless: RCN-E1R

Once you have enabled the settings in this mode, the anti draft function is operated when the air-conditioner is started, and the parts of the anti draft mechanism are always open when the air-conditioner is operating. When the air-conditioner is stopped, they are closed. It is possible to enable or disabled the anti draft function for each air outlet.







For the setting details, refer to the user's manual supplied with the remote control.

PJF012D509 























(2) Ceiling cassette-4 way compact type(FDTC)

This manual is for the installation of the indoor unit.
 For electrical wiring work (Indoor unit), refer to page 91. For remote control installation, refer to page 95.
 For wireless kit installation, refer to page 149. For electrical wiring work (Outdoor unit) and refrigerant pipe work installation for outdoor unit, refer to page 107. For motion sensor kit installation, refer to page 177.
 This unit must always be used with the panel.





























SAFETY PRECAUTIONS

- Read the "SAFETY PRECAUTIONS" carefully first of all and then strictly follow it during the installation work in order to protect yourself.
- The precautionary items mentioned below are distinguished into two levels,  **WARNING** and  **CAUTION**.
 **WARNING**: Wrong installation would cause serious consequences such as injuries or death.
 **CAUTION**: Wrong installation might cause serious consequences depending on circumstances.
 Both mentions the important items to protect your health and safety so strictly follow them by any means.
- The meanings of "Marks" used here are as shown on the right:
 Never do it under any circumstances.  Always do it according to the instruction.
- After completing the installation, do commissioning to confirm there are no abnormalities, and explain to the customers about "SAFETY PRECAUTIONS", correct operation method and maintenance method (air filter cleaning, operation method and temperature setting method) with user's manual of this unit.
 Ask your customers to keep this installation manual together with the user's manual. Also, ask them to hand over the user's manual to the new user when the owner is changed.

 **WARNING**

- **Installation should be performed by the specialist.** 
 If you install the unit by yourself, it may lead to serious trouble such as water leakage, electric shock, fire, and injury due to overturn of the unit.
- **Install the system correctly according to these installation manuals.** 
 Improper installation may cause explosion, injury, water leakage, electric shock, and fire.
- **Check the density referred by the formula (accordance with ISO5149).** 
 If the density exceeds the limit density, please consult the dealer and installate the ventilation system.
- **Use the genuine accessories and the specified parts for installation.** 
 If parts unspecified by our company are used it could cause water leakage, electric shock, fire, and injury due to overturn of the unit.
- **Ventilate the working area well in case the refrigerant leaks during installation.** 
 If the refrigerant contacts the fire, toxic gas is produced.
 In case of R32, the refrigerant could be ignited because of its flammability.
- **Install the unit in a location that can hold heavy weight.** 
 Improper installation may cause the unit to fall leading to accidents.
- **Install the unit properly in order to be able to withstand strong winds such as typhoons, and earthquakes.** 
 Improper installation may cause the unit to fall leading to accidents.
- **Do not mix air in to the cooling cycle on installation or removal of the air-conditioner.** 
 If air is mixed in, the pressure in the cooling cycle will rise abnormally and may cause explosion and injuries.
- **Be sure to have the electrical wiring work done by qualified electrical installer, and use exclusive circuit.** 
 Power source with insufficient capacity and improper work can cause electric shock and fire.
- **Use specified wire for electrical wiring, fasten the wiring to the terminal securely, and hold the cable securely in order not to apply unexpected stress on the terminal.** 
 Loose connections or hold could result in abnormal heat generation or fire.
- **Arrange the electrical wires in the control box properly to prevent them from rising. Fit the lid of the services panel properly.** 
 Improper fitting may cause abnormal heat and fire.
- **Check for refrigerant gas leakage after installation is completed.** 
 If the refrigerant gas leaks into the house and comes in contact with a fan heater, a stove, or an oven, toxic gas is produced.
- **Use the specified pipe, flare nut, and tools for R32 or R410A.** 
 Using existing parts (R22) could cause the unit failure and serious accident due to explosion of the cooling cycle.
- **Tighten the flare nut according to the specified method by with torque wrench.** 
 If the flare nut were tightened with excess torque, it could cause burst and refrigerant leakage after a long period.
- **Do not put the drainage pipe directly into drainage channels where poisonous gases such as sulfide gas can occur.** 
 Poisonous gases will flow into the room through drainage pipe and seriously affect the user's health and safety. This can also cause the corrosion of the indoor unit and a resultant unit failure or refrigerant leak.
- **Connect the pipes for refrigeration circuit securely in installation work before compressor is operated.** 
 If the compressor is operated when the service valve is open without connecting the pipe, it could cause explosion and injuries due to abnormal high pressure in the system.
- **Stop the compressor before removing the pipe after shutting the service valve on pump down work.** 
 If the pipe is removed when the compressor is in operation with the service valve open, air would be mixed in the refrigeration circuit and it could cause explosion and injuries due to abnormal high pressure in the cooling cycle.
- **Only use prescribed option parts. The installation must be carried out by the qualified installer.** 
 If you install the system by yourself, it can cause serious trouble such as water leaks, electric shocks, fire.
- **Do not repair by yourself. And consult with the dealer about repair.** 
 Improper repair may cause water leakage, electric shock or fire.
- **Consult the dealer or a specialist about removal of the air-conditioner.** 
 Improper installation may cause water leakage, electric shock or fire.
- **Turn off the power source during servicing or inspection work.** 
 If the power is supplied during servicing or inspection work, it could cause electric shock and injury by the operating fan.
- **Do not run the unit when the panel or protection guard are taken off.** 
 Touching the rotating equipment, hot surface, or high voltage section could cause an injury to be caught in the machine, to get burned, or electric shock.
- **Shut off the power before electrical wiring work.** 
 It could cause electric shock, unit failure and improper running.

 **CAUTION**

- **Perform earth wiring surely.** 
 Do not connect the earth wiring to the gas pipe, water pipe, lightning rod and telephone earth wiring. Improper earth could cause unit failure and electric shock due to a short-circuit.
- **Earth leakage breaker must be installed.** 
 If the earth leakage breaker is not installed, it can cause electric shocks.
- **Use the circuit breaker of correct capacity. Circuit breaker should be the one that disconnect all poles under over current.** 
 Using the incorrect one could cause the system failure and fire.
- **Do not use any materials other than a fuse of correct capacity where a fuse should be used.** 
 Connecting the circuit by wire or copper wire could cause unit failure and fire.
- **Do not install the indoor unit near the location where there is possibility of flammable gas leakages.** 
 If the gas leaks and gathers around the unit, it could cause fire.
- **Do not install and use the unit where corrosive gas (such as sulfurous acid gas etc.) or flammable gas (such as thinner, petroleum etc.) may be generated or accumulated, or volatile flammable substances are handled.** 
 It could cause the corrosion of heat exchanger, breakage of plastic parts etc. And inflammable gas could cause fire.
- **Secure a space for installation, inspection and maintenance specified in the manual.** 
 Insufficient space can result in accident such as personal injury due to falling from the installation place.
- **Do not use the indoor unit at the place where water splashes such as laundry.** 
 Indoor unit is not waterproof. It could cause electric shock and fire.
- **Do not use the indoor unit for a special purpose such as food storage, cooling for precision instrument, preservation of animals, plants, and a work of art.** 
 It could cause the damage of the items.
- **Do not install nor use the system near equipments which generate electromagnetic wave or high harmonics.** 
 Equipments like inverter equipment, private power generator, high-frequency medical equipment, or telecommunication equipment might influence the air-conditioner and cause a malfunction and breakdown. Or the air-conditioner might influence medical equipments or telecommunication equipments, and obstruct their medical activity or cause jamming.
- **Do not install the remote control at the direct sunlight.** 
 It could cause breakdown or deformation of the remote control.
- **Do not install the indoor unit at the place listed below.** 
 - Places where flammable gas could leak.
 - Places where carbon fiber, metal powder or any powder is floated.
 - Place where the substances which affect the air conditioner are generated such as sulfide gas, chloride gas, acid, alkali or ammoniac atmospheres.
 - Places exposed to oil mist or steam directly.
 - On vehicles and ships
 - Places where machinery which generates high harmonics is used.
 - Places where cosmetics or special sprays are frequently used.
 - Highly salted area such as beach.
 - Heavy snow area
 - Places where the system is affected by smoke from a chimney.
 - Altitude over 1000m
- **Do not install the indoor unit in the locations listed below (Be sure to install the indoor unit according to the installation manual for each model because each indoor unit has each limitation)** 
 - Locations with any obstacles which can prevent inlet and outlet air of the unit.
 - Locations where vibration can be amplified due to insufficient strength of structure.
 - Locations where the infrared receiver is exposed to the direct sunlight or the strong light beam. (in case of the infrared specification unit)
 - Locations where an equipment affected by high harmonics is (TV set or radio receiver is placed within 5m)
 - Locations where drainage cannot run off safely. It can affect performance or function and etc..
 - Do not install the motion sensor mounting panel at following places. It could cause detection error, incapacity of detection, or characteristic degradation.
 - Place where vibration is applied to it for a long period of time.
 - Place where static electricity or electromagnetic wave generates.
 - Place where it is exposed to high temperature or humidity for a long period of time.
 - Dusty place or where the lens face could be fouled or damaged.
- **Do not put any valuables which will break down by getting wet under the air-conditioner.** 
 Condensation could drop when the relative humidity is higher than 80% or drain pipe is clogged, and it damages user's belongings.
- **Do not use the base frame for the outdoor unit which is corroded or damaged after a long period of use.** 
 It could cause the unit falling down and injury.
- **Pay attention not to damage the drain pan by weld sputter when brazing work is done near the unit.** 
 If sputter entered into the unit during brazing work, it could cause damage (pinhole) of drain pan and leakage of water. To avoid damaging, keep the indoor unit packed or cover the indoor unit.
- **Install the drain pipe to drain the water surely according to the installation manual.** 
 Improper connection of the drain pipe may cause dropping water into room and damaging user's belongings.
- **Be sure to perform air tightness test by pressurizing with nitrogen gas after completed refrigerant piping work.** 
 If the density of refrigerant exceeds the limit in the event of refrigerant leakage in the small room, lack of oxygen can occur, which can cause serious accidents.
- **For drain pipe installation, be sure to make descending slope of greater than 1/100, not to make traps, and not to make air-bleeding.** 
 Check if the drainage is correctly done during commissioning and ensure the space for inspection and maintenance.
- **Ensure the insulation on the pipes for refrigeration circuit so as not to condense water.** 
 Incomplete insulation could cause condensation and it would wet ceiling, floor, and any other valuables.
- **Do not install the outdoor unit where is likely to be a nest for insects and small animals.** 
 Insects and small animals could come into the electronic components and cause breakdown and fire. Instruct the user to keep the surroundings clean.
- **Pay extra attention, carrying the unit by hand.** 
 Carry the unit with 2 people if it is heavier than 20kg. Do not use the plastic straps but the grabbing place, moving the unit by hand. Use protective gloves in order to avoid injury by the aluminum fin.
- **Make sure to dispose of the packaging material.** 
 Leaving the materials may cause injury as metals like nail and woods are used in the package.
- **Do not operate the system without the air filter.** 
 It may cause the breakdown of the system due to clogging of the heat exchanger.
- **Do not touch any button with wet hands.** 
 It could cause electric shock.
- **Do not touch the refrigerant piping with bare hands when in operation.** 
 The pipe during operation would become very hot or cold according to the operating condition, and it could cause a burn or frostbite.
- **Do not clean up the air-conditioner with water.** 
 It could cause electric shock.
- **Do not turn off the power source immediately after stopping the operation.** 
 Be sure to wait for more than 5 minutes. Otherwise it could cause water leakage or breakdown.
- **Do not control the operation with the circuit breaker.** 
 It could cause fire or water leakage. In addition, the fan may start operation unexpectedly and it may cause injury.

① Before installation

- Install correctly according to the installation manual.
- Confirm the following points:
 - Unit type/Power source specification
 - Pipes/Wires/Small parts
 - Accessory items

Accessory item

For unit hanging		For refrigerant pipe			For drain pipe			
Flat washer (M10)	Level gage	Pipe cover(big)	Pipe cover (small)	Strap	Pipe cover(big)	Pipe cover(small)	Drain hose	Hose clamp
8	1	1	1	4	1	1	1	1
For unit hanging	For hanging and leveling of unit	For heat insulation of gas pipe	For heat insulation of liquid tube	For pipe cover fixing	For heat insulation of drain socket	For heat insulation of drain socket	For drain pipe connecting	For drain hose mounting

When moving the indoor unit, hold only the hanging hardware (4 places) only, with care not to apply forces to any other parts of the unit (particularly the refrigerant pipe, drain pipe, and resin parts).

② Selection of installation location for the indoor unit

- Select the suitable areas to install the unit under approval of the user.
 - Areas where the indoor unit can deliver hot and cold wind sufficiently. Suggest to the user to use a circulator if the ceiling height is over 3m to avoid warm air being accumulated on the ceiling.
 - In case of the panel having the motion sensor, the installation height must be no higher than 4 m. It could reduce the sensitivity of motion sensor, disabling the detection.
 - Areas where there is enough space to install and service.
 - Areas where it can be drained properly. Areas where drain pipe descending slope can be taken.
 - Areas where there is no obstruction of air flow on both air return grille and air supply port.
 - Areas where fire alarm will not be accidentally activated by the air-conditioner.
 - Areas where the supply air does not short-circuit.
 - Areas where it is not influenced by draft air.
 - Areas not exposed to direct sunlight.
 - Areas where dew point is lower than around 28°C and relative humidity is lower than 80%. This indoor unit is tested under the condition of JIS (Japan Industrial Standard) high humidity condition and confirmed there is no problem. However, there is some risk of condensation drop if the air-conditioner is operated under the severer condition than mentioned above.
 - If there is a possibility to use it under such a condition, attach additional insulation of 10 to 20mm thick for entire surface of indoor unit, refrigeration pipe and drain pipe.
 - Areas where TV and radio stays away more than 1m. (It could cause jamming and noise.)
 - Areas where any items which will be damaged by getting wet are not placed such as food, table wares, server, or medical equipment under the unit.
 - Areas where there is no influence by the heat which cookware generates.
 - Areas where not exposed to oil mist, powder and/or steam directly such as above fryer.
 - Areas where lighting device such as fluorescent light or incandescent light doesn't affect the operation. (A beam from lighting device sometimes affects the infrared receiver for the wireless remote control and the air-conditioner might not work properly.)
- Check if the place where the air-conditioner is installed can hold the weight of the unit. If it is not able to hold, reinforce the structure with boards and beams strong enough to hold it. If the strength is not enough, it could cause injury due to unit falling.
- If there are 2 units of wireless type, keep them away for more than 6m to avoid malfunction due to cross communication.
- When plural indoor units are installed nearby, keep them away for more than 4m.

Space for installation and service

- When it is not possible to keep enough space between indoor unit and wall or between indoor units, close the air supply port where it is not possible to keep space and confirm there is no short-circuit of air flow.
- Install the indoor unit at a height of more than 2.5m above the floor.

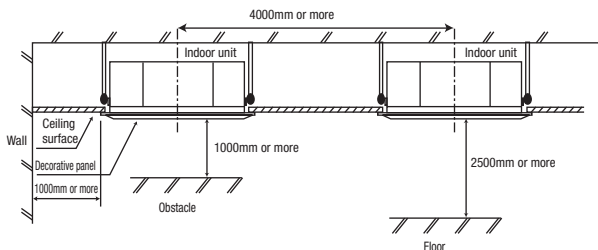

Set blow-out pattern

- Select the most proper number of blow-out air supply port direction from 4 way, 3 way or 2 way according to the shape of the room and installation position. (1 way is not available.)
- If it is necessary to change the number of air supply port, prepare the covering materials. (sold as accessory)
- Instruct the user not to use low fan speed when 2way or 3way air supply is used.
- Do not use 2way air supply port under high temperature and humidity environment. (Otherwise it could cause condensation and leakage of water.)
- It is possible to set the air flow direction port by port independently. Refer to the user's manual for details.

Where there are pipe joints on the way of embedded piping, provide adequate openings for inspection of the joints.

③ Preparation before installation

- If suspension bolt becomes longer, do reinforcement of earthquake resistant.
 - For grid ceiling
 - When suspension bolt length is over 500mm, or the gap between the ceiling and roof is over 700mm, apply earthquake resistant brace to the bolt.
 - In case the unit is hanged directly from the slab and is installed on the ceiling plane which has enough strength.
 - When suspension bolt length is over 1000mm, apply the earthquake resistant brace to the bolt.
- Prepare four (4) sets of suspension bolt, nut and spring washer (M10 or M8) on site.

Ceiling opening, Suspension bolts pitch, Pipe position

Symbol	Content
A	Gas piping
B	Liquid piping
C	Drain piping
D	Power source connection
Dz	Remote control code and signal wiring connection
F	Suspension bolts
G	Outside air opening for ducting
H	Air outlet opening for ducting
J	Inspection opening

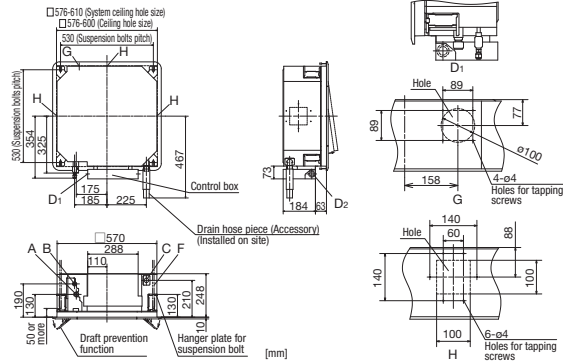
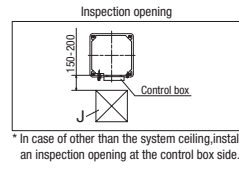

④ Installation of indoor unit

Work procedure

- This unit is designed to install on a system ceiling. If necessary, remove T bars temporarily before installing the unit. When it is installed on a ceiling other than the system ceiling, install an inspection port at the control box side.
- Determine the position of suspension bolts (530 mm × 530 mm).
- Use 4 suspension bolts, and fix them such that each bolt can withstand a pull-out load of 500 N.
- Set the suspension bolt length to about 50 mm from the ceiling.
- Temporarily locate the lower nuts of the suspension bolts (4 places) at a position approximately 130 mm from the ceiling.
- Temporarily locate the upper nuts of the suspension bolts (4 places) at positions sufficiently distance from the lower nuts so that they do not interfere with the suspension of the indoor unit and with its height adjustment.
- Set the upper nuts of the suspension bolts and upper washers (4 places) at positions sufficiently distance from the lower nuts. Then, push and insert the temporary fixing carton of washers (*1) onto suspension bolts. Make sure that the upper washers do not slide down.
- Suspend the indoor unit.
- After suspending the indoor unit, mount the level gauge (*2) to the air outlet of the indoor unit, and adjust the suspension height of the indoor unit. Loosen the upper nuts (4 places), and adjust the suspension height using the lower nuts (4 places). Confirm there is no slack between the lower nuts and flat washers of the indoor unit hanger plate (4 places).
- Remove the temporary fixing carton of washers (from all 4 places).
- Make sure that the indoor unit is installed horizontally. Confirm the levelness of the indoor unit using a level gauge or transparent hose filled with water. (Keep the height difference at both ends of the indoor unit within 3 mm.)
- Tighten the upper nuts of the suspension bolts (4 places).

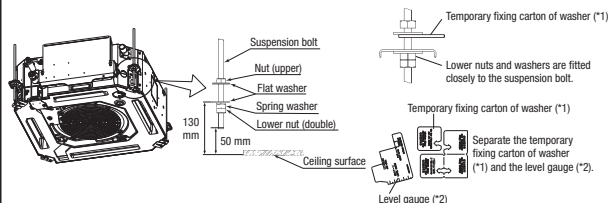

<-In case of other than the system ceiling->

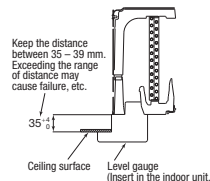

<-In case of the system ceiling->

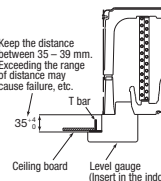

④ Installation of indoor unit (continued)

Protection of the indoor unit

- If it is not possible to install the panel for a while or if attaching the ceiling board after installing the indoor unit, protect the indoor unit by using upper carton.

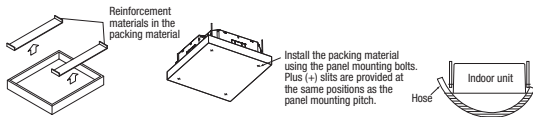

Caution

- Do not adjust the unit height by adjusting the upper nuts. Doing so will cause unexpected stress on the indoor unit and cause the unit to become deformed, prevent the panel from being installed, and be generated fan interference noise.
- Make sure that the indoor unit is installed horizontally and set the appropriate gap between the underside of the unit and the ceiling plane. Improper installation may cause air leakage, dew condensation, water leakage and noise.
- Make sure there is no gap between the panel and the ceiling surface, and between the panel and the indoor unit. Any gap may cause air and/or water to leak, or condensation to form.

⑤ Refrigerant pipe

Caution

- Be sure to use new pipes for the refrigerant pipes. Use the flare nut attached to the product. Regarding whether existing pipes can be reused or not, and the washing method, refer to the instruction manual of the outdoor unit, catalogue or technical data.
 - 1) In case of reuse: Do not use old flare nut, but use the nut attached to the unit.
 - 2) In case of reuse: Flare the end of pipe replaced partially for R32 or R410A.

⚠ WARNING : When flared joints are reused indoors, the flare part shall be re-fabricated. (only for R32)

Pipe dia. d mm	Min. pipe wall thickness mm	Protruding dimension for flare, mm		Flare O.D. D mm	Flare nut tightening torque N·m
		Rigid (Clutch type) For R32 For R410A	Conventional tool		
6.35	0.8	0 - 0.5	0.7 - 1.3	8.9 - 9.1	14 - 18
9.52	0.8			12.8 - 13.2	34 - 42
12.7	0.8			16.2 - 16.6	49 - 61
15.88	1			19.3 - 19.7	68 - 82
19.05	1.2			23.6 - 24.0	100 - 120

- Use phosphorus deoxidized copper alloy seamless pipe (C1220T) for refrigeration pipe installation. In addition, make sure there is no damage both inside and outside of the pipe, and no harmful substances such as sulfur, oxide, dust or a contaminant stuck on the pipes.
- Do not use any refrigerant other than the designated refrigerant. Using other refrigerant except the designated refrigerant, may degrade inside refrigeration oil. And air getting into refrigeration circuit may cause over-pressure and resultant it may result in bursting, etc.
- Store the copper pipes indoors and seal the both end of them until they are brazed in order to avoid any dust, dirt or water getting into pipe. Otherwise it will cause degradation of refrigeration oil and compressor breakdown, etc.
- Use special tools for R32 or R410A refrigerant.

Work procedure

1. Remove the flare nut and blind flanges on the pipe of the indoor unit.
 - ※ Make sure to loosen the flare nut with holding the nut on pipe side with a spanner and giving torque to the nut with another spanner in order to avoid unexpected stress to the copper pipe, and then remove them. (Gas may come out at this time, but it is not abnormal.)
 - Pay attention whether the flare nut pops out. (as the indoor unit is sometimes pressured.)
2. Make a flare on liquid pipe and gas pipe, and connect the refrigeration pipes on the indoor unit.
 - ※ Bend radius of pipe must be 4D or larger. Once a pipe is bent, do not readjust the bending. Do not twist a pipe or collapse to 2/3D or smaller.
 - Make sure to use flare nuts assembled on the unions. Usage of other flare nuts could cause refrigerant leakage.
 - ※ Do a flare connection as follows:
 - Make sure to hold the nut on indoor unit pipe side using double spanner method as indicated when fastening / loosening flare nuts in order to prevent unintentional twisting of the copper pipe.
 - When fastening the flare nut, align the refrigeration pipe with the center of flare nut, screw the nut for 3-4 times by hand and then tighten it by spanner with the specified torque mentioned in the table above.
3. Cover the flare connection part of the indoor unit with attached insulation material after a gas leakage inspection, and tighten both ends with attached straps.
 - Make sure to insulate both gas pipes and liquid pipes completely.
 - ※ Incomplete insulation may cause dew condensation or water dropping.
 - Use heat-resistant (120 °C or more) insulations on the gas side pipes.
 - In case of using at high humidity condition, reinforce insulation of refrigerant pipes. Surface of insulation may cause dew condition or water dropping, if insulations are not reinforced.
4. Refrigerant is charged in the outdoor unit. As for the additional refrigerant charge for the indoor unit and piping, refer to the installation manual attached to the outdoor unit.

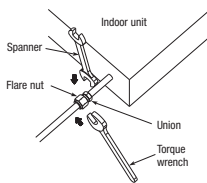

⑤ Refrigerant pipe (continued)

Caution:

Refrigerating machine oil should not be applied to the threads of union or external surface of flare. It is because, even if the same tightening torque is applied, the oil is likely to decrease the slide friction force on the threads and increase, in turn, the axial component force so that it could crack the flare by the stress corrosion. Refrigerating machine oil may be applied to the internal surface of flare only.

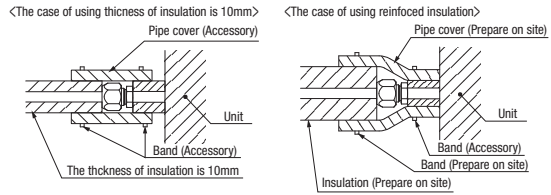

⑥ Drain pipe

Caution

- Install the drain pipe according to the installation manual in order to drain properly. Imperfection in draining may cause flood indoors and wetting the household goods, etc.
- Do not put the drain pipe directly into the ditch where toxic gas such as sulfur, the other harmful and inflammable gas is generated. Toxic gas would flow into the room and it would cause serious damage to user's health and safety (some poisoning or deficiency of oxygen). In addition, it may cause corrosion of heat exchanger and bad smell.
- Connect the pipe securely to avoid water leakage from the joint.
- Insulate the pipe properly to avoid condensation drop.
- Check if the water can flow out properly from both the drain outlet on the indoor unit and the end of the drain pipe after installation.
- Make sure to make descending slope of greater than 1/100 and do not make up-down bend and/or trap in the midway. In addition, do not put air vent on the drain pipe. Check if water is drained out properly from the pipe during commissioning. Also, keep sufficient space for inspection and maintenance.

Work procedure

1. Make sure that the drain hose (the soft PVC side) is inserted into the end of the step part of the drain socket. Fix the hose clamp so that its bolt is located on the outside of the indoor unit, and the bolt are fastened in a vertical orientation.
 - Do not apply adhesives on this end.
2. Position the hose clamp so that it touches the insulation of the drain hose, and then tighten the bolt.
3. Turn the bolt several times until it is securely tightened, but do not tighten it excessively.

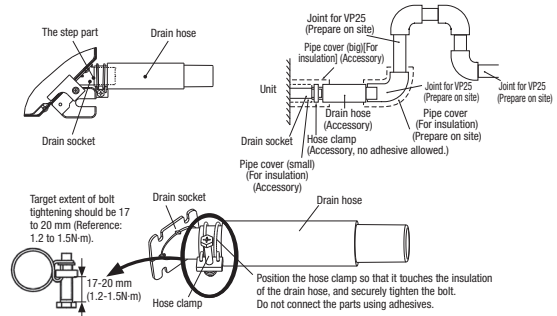

4. Prepare a joint for connecting VP25 pipe, adhere and connect the joint to the drain hose (the rigid PVC side), and adhere and connect VP25 pipe (prepare on site).
 - ※ As for drain pipe, apply VP25 made of rigid PVC which is on the market.
 - Make sure that the adhesive will not get into the supplied drain hose. It may cause the flexible part broken after the adhesive is dried up and gets rigid.
 - The flexible drain hose is intended to absorb a small difference at installation of the unit or drain pipes. Intentional bending, expanding may cause the flexible hose broken and water leakage.
 - As for drain pipe, apply VP25 (OD32). If apply PVC25 (OD25), connect the expanded connector to the drain hose, with adhesive. (Multi unit only)

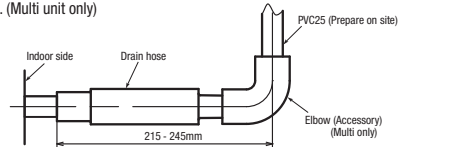

5. Make sure to make descending slope of greater than 1/100 and do not make up-down bend and/or trap in the midway.
 - Pay attention not to give stress on the pipe on the indoor unit side, and support and fix the pipe as close place to the unit as possible when connecting the drain pipe.
 - Do not set up air vent.

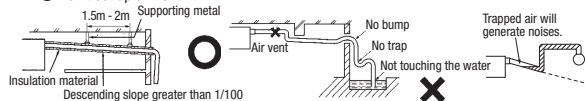

⑥ Drain pipe (continued)

- When sharing a drain pipe for more than 1 unit, lay the main pipe 100mm below the drain outlet of the unit. In addition, select VP30 or bigger size for main drain pipe.

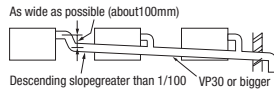

6. Insulate the drain pipe.

- Be sure to insulate the drain socket and rigid PVC pipe installed indoors otherwise it may cause dew condensation and water leakage.
- ※ After drainage test implementation, cover the drain socket part with pipe cover (small size), then use the pipe cover (big size) to cover the pipe cover (small size), clamps and part of the drain hose, and fix and wrap it with tapes to wrap and make joint part gasless.

Drain up

- The position for drain pipe outlet can be raised up to 850mm above the ceiling. Use elbows for installation to avoid obstacles inside ceiling. If the horizontal drain pipe is too long before vertical pipe, the backflow of water will increase when the unit is stopped, and it may cause overflow of water from the drain pan on the indoor unit. In order to avoid overflow, keep the horizontal pipe length and offset of the pipe within the limit shown in the figure below.

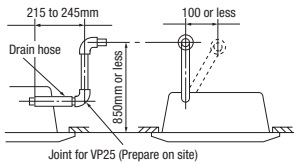

Drain test

- After installing the drain pipe, make sure that drain system works correctly and that no water leaks from the joint and drain pan. Check whether the motor sound of the drain pump is normal.
- Conduct a drain test when installing, even during the heating season.
- In the case of new buildings, be sure to complete the test before fixing the ceiling.

1. Pour about 1,000 cc of test water into the drain pan of the indoor unit. Exercise care not to allow electrical equipment such as the drain pump and other components to become wet while filling water.

Pour test water through the pipe lid using a feed water pump or a similar device, or through the refrigerant pipe joint.

- In case of pouring water from the air outlet

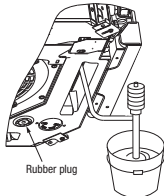

- In case of pouring water from the pipe lid
- (1) Remove screws at 2 places.
 - (2) Release the claws, and remove the lid.

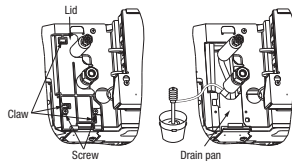

2. Make sure that water drains out completely and that no water leaks from any joints of the drain pipe during the test.
Test to confirm that the water drains out correctly while listening to the drain pump motor operating sound. At the drain socket (transparent), it is possible to check whether the water drains out correctly.
3. Unplug the rubber plug on the indoor unit so that the remaining water drains from the drain pan after the draining test.
After checking the water drainage, fix the rubber plug correctly. Installation work for the drain pipe must be performed for the entire drain pipe up to the indoor unit.
If the pipe lid has been removed in order to pour water, mount the pipe lid again.

Drain pump operation

- In case electrical wiring work completed
Drain pump can be operated by the wired remote control.
For the operation method, refer to [Operation for drain pump] in the installation manual for wiring work.
- In case electrical wiring work not completed
Drain pump will run continuously when the dip switch "SW7-1" on the indoor unit PCB is turned ON, the connector CnB is disconnected, and then the power source (230VAC on the terminal block ① and ②) is turned ON. Make sure to turn OFF "SW7-1" and reconnect the connector CnB after the test.

⑦ Wiring-out position and wiring connection

- Electrical installation work must be performed according to the installation manual by an electrical installation service provider qualified by a power provider of the country, and be executed according to the technical standards and other regulations applicable to electrical installation in the country.
 - Be sure to use an exclusive circuit.
 - Use specified cord, fasten the wiring to the terminal securely, and hold the cord securely in order not to apply unexpected stress on the terminal.
 - Do not put both power source line and signal line on the same route. It may cause miscommunication and malfunction.
 - Be sure to do D type earth work.
 - For the details of electrical wiring work, see attached instruction manual for electrical wiring work.
1. Loosen screws (2 pcs.) on the control box of the unit.
 2. Remove the control lid by sliding it in the arrow direction in the figure.
 3. Introduce the wiring in the control box, and connect it securely to the terminal block.
 4. Fix the wiring with bands as shown below.
 5. Install the control lid, with care not to pinch the wiring, and fix the lid with screws (2 pcs.).

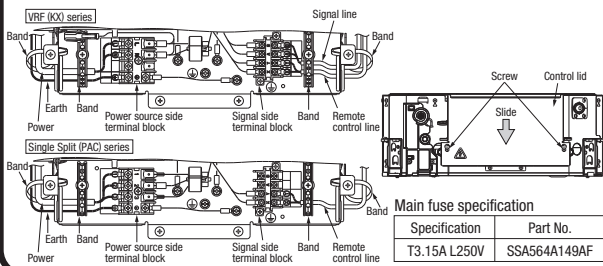

⑧ Panel installation

- Install the panel on the indoor unit after electrical wiring work.
- Refer to the attached manual for panel installation for details.

⑨ Check list after installation

- Check the following items after all installation work completed.

Check if;	Expected trouble	Check
The indoor and outdoor units are fixed securely?	Falling, vibration, noise	
Inspection for leakage is done?	Insufficient capacity	
Insulation work is properly done?	Water leakage	
Water is drained properly?	Water leakage	
Power source voltage is same as mentioned in the model name plate?	PCB burnt out, not working at all	
There is mis-wiring or mis-connection of piping?	PCB burnt out, not working at all	
Earth wiring is connected properly?	Electric shock	
Cable size comply with specified size?	PCB burnt out, not working at all	
Any obstacle blocks air flow on air inlet and outlet?	Insufficient capacity	

⑩ How to check the dirt of drain pan and cleaning the inlet of the drain pump. (Maintenance)

The method of checking the dirt of drain pan

1. Remove the panel according to the installation manual of the panel.
2. Check the dirt on the drain pan from the drain cap, and check the drain pump inlet. If the drain pan is very dirty, remove the drain pan and clean it.

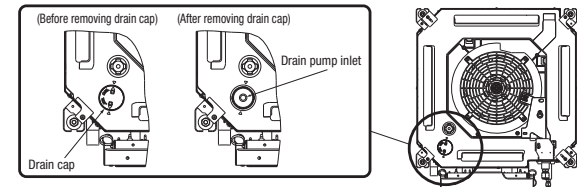

Cleaning of drain pump inlet

- It is possible to clean the drain pump inlet and surrounding area by removing the drain cap only; it is not necessary to remove the drain pan.
 - Before removing the drain cap, remove the rubber plug and drain water from the drain pan.
1. Insert the nose of the pliers into the concave portions (2 places) of the drain cap, and rotate the pliers about 1 turn in the CCW direction. The drain cap is removed.
 2. When cleaning the drain pump inlet, use a soft plastic tool. If a metallic tool is used, the drain cap mounting portion may be scratched and water may leak.
 3. Before mounting the drain cap, rinse it and **remove any foreign material from the inside of the cap**. If the drain cap is installed with foreign material inside it, it may cause water to leak.
 4. Insert the nose of the pliers into the concave portions of the drain cap and rotate the pliers to install the drain cap. Rotate the drain cap about 1 turn in the CW direction until it stops rotating. If the drain cap is not rotated for 1 or more turns, the cap will not have been installed correctly. Remove the drain cap, and then install it again correctly.
 5. After tightening the drain cap, make sure the triangle (▲) mark of the drain cap comes close to the triangle mark on the drain pan. If these triangle marks are not close to each other, tighten the drain cap further.
 6. Refix the rubber plug securely. If the cover is not refixed correctly, it may cause condensation to form and/or water to leak.

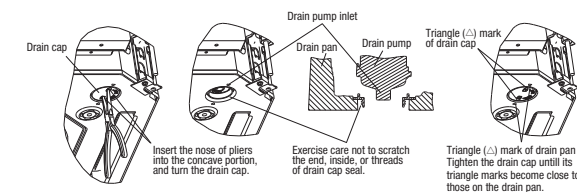

Notes for removing the drain pan

- Before removing the drain pan, drain water from the drain pan. Remove the rubber plug and drain water.
- The drain pan is installed by the temporary installation plate. Remove the 2 drain pan fixing screws, and loosen the 2 screws of the temporary installation plate. Slide the temporary installation plate to the outside of the drain pan. And then, it is possible to remove the drain pan.
- When reinstalling the drain pan, slide the temporary installation plate to the inside and temporarily fix the drain pan. Then, tighten the 2 drain pan fixing screws and the 2 screws of the temporary installation plate. Also, refix the rubber plug securely.

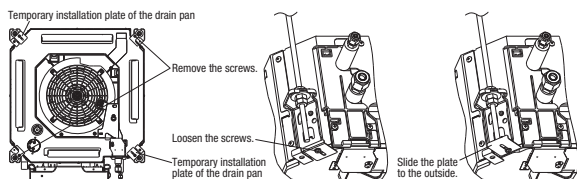

• Panel installation

PJF012D503 

Read this manual together with the indoor unit's installation manual.

* Caution before use

- Be careful the installation height when installing the indoor unit.
Also note that the installation height of this indoor unit is different from that of current (old) unit.
Installation height from the ceiling surface to the indoor unit.
• Old unit: 30 mm → This unit: 35 $\frac{1}{2}$ mm

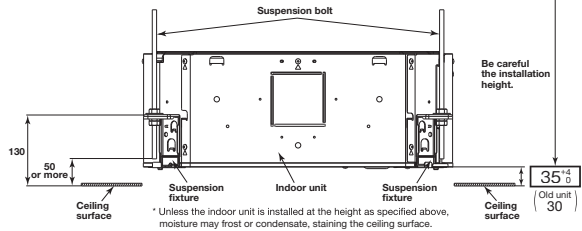

- Do not attempt to move forcibly the louver and the air flex.

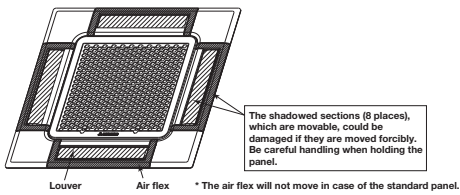

⚠ WARNING

- Fasten the wiring to the terminal securely and hold the cable securely so as not to apply unexpected stress on the terminal. Loose connection or hold will cause abnormal heat generation or fire.
- Make sure the power source is turned off when electric wiring work. Otherwise, electric shock, malfunction and improper running may occur.





Function

The draft prevention panel has the draft prevention mechanism. If the draft prevention panel is installed and the draft prevention function is set, the draft prevention function will be operated and reduce the draft feeling. (Refer to **⑩ Panel setting** for details.)

- Standard panel : without the draft prevention mechanism
- Draft prevention panel : with the draft prevention mechanism

① Before installation

- Follow installation manual carefully, and install the panel properly.
- Check the following items.
- Accessories

Accessories		
	4 pieces	For panel installation
	4 pieces	For avoiding the corner panel from falling
	1 piece	For avoiding the grille from falling
	4 pieces	For fixing the corner panel

Note: Accessories are laid in the position removing the corner lid.

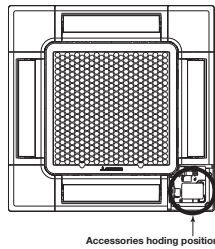

② Checking the indoor unit installation height

- Read this manual together with the air-conditioner installation manual carefully.
- Check if the opening size for the indoor unit is correct with the level gauge supplied in the indoor unit.
- Check if the gap between the plane and the indoor unit is correct by inserting the level gauge into the air outlet port of the indoor unit. (See below drawing)
- Adjust the installation elevation if necessary.
- Remove the level gauge before installing the panel.

Caution
If there is a height difference beyond the design limit between the installation level of the indoor unit and the panel, the panel may be subject to excessive stress during installation and it may cause distortion and damage.

<In case of other than the system ceiling>

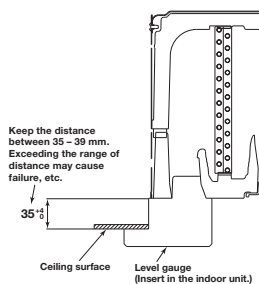

<In case of the system ceiling>

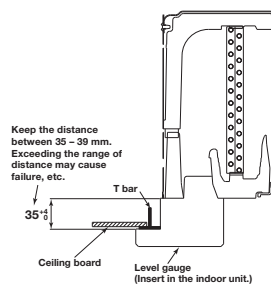

③ Removing the inlet grille

- While placing a finger behind the stopper (2 places) and pressing it in the direction of arrow ①, pull the grille downward to open the grille.
- Release the hooks of the inlet grille from the panel while it is in the open position.

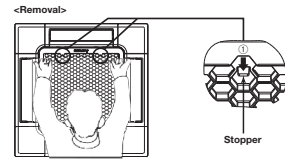

④ Removing the corner lid

- Pull the corner lid toward the direction indicated by the arrow and remove it. (Same way for all 4 corner lids)

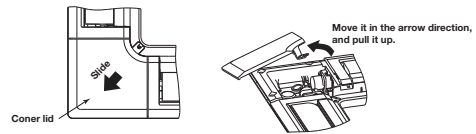

⑤ Before installing the panel <Only Draft prevention panel>

- Loosen screws (2 pcs.) on the control lid of the unit.
- Slide the control lid in the arrow direction in the figure, and remove it.
- Loosen screws on the wiring cover (2 places).
- Slide the wiring cover (2 places) in the arrow direction in the figure, and remove it.
- Disconnect the relay connector of the air flex motor wiring attached to the panel.
- Connect the air flex motor wiring to CNJ2 (20 P, gray) on PCB in the control box of the unit.
- Pass the air flex motor wiring as shown in the figure.
- Install the wiring cover (1 piece) with care not to pinch wiring, and fix it with a screw.
- Fix the air flex motor wiring with a band as shown in the figure.
- Install the control lid with care not to pinch wiring, and fix with screws (2 places.).

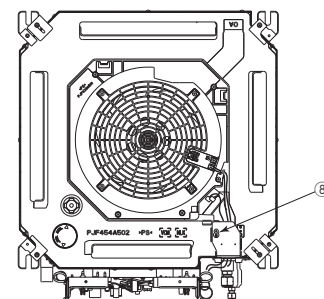
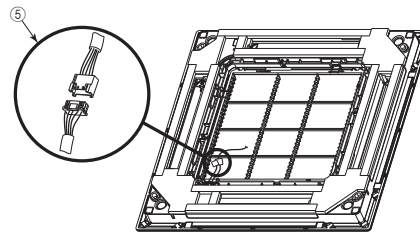
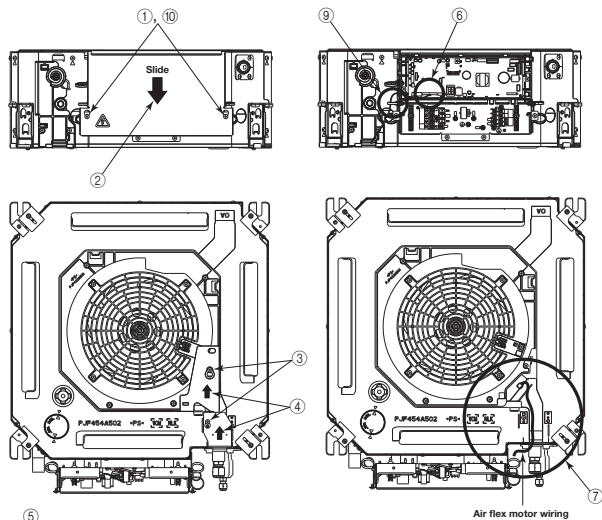

⑥ Orientation of the panel installation

- Take note that there is an orientation to install the panel.
- Install the panel with the orientation shown on the right.
 - Align the "PIPE SIDE" mark (on the panel) with the refrigerant pipes on the indoor unit.
 - Align the "DRAIN" mark (on the panel) with the drain pipe on the indoor unit.

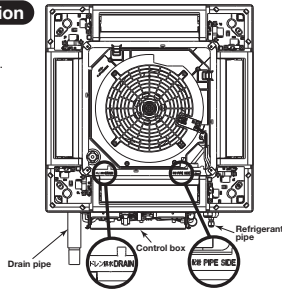

CAUTION

In case the orientation of the panel is not correct, it will lead to air leakage and also it is not possible to connect the motor wiring.

⑦ Installing the panel

1. Temporary hanging

- Lift up the hanger (2 places) on the panel for temporary support.
- Hang the panel on the hook on the indoor unit.

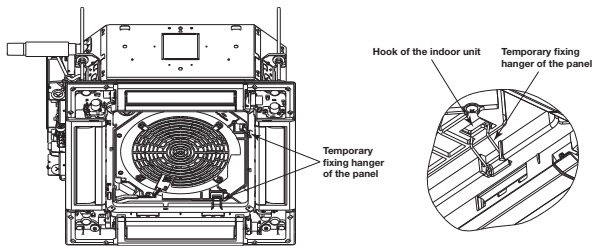

2. Fix the panel on the indoor unit

- Fasten the panel on the indoor unit with the 4 bolts supplied with the panel.

Caution

Be careful not to pinch the motion sensor wiring.

Caution

• Improperly tightened fixing bolts cause the problems listed below, so make sure that bolts are securely tightened.

• If there is a gap between the ceiling and the panel even after the fixing bolts are tightened, adjust the installation level of the indoor unit again.

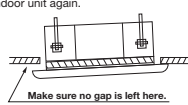
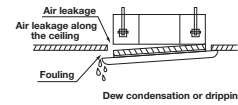

Bolt for installing the panel

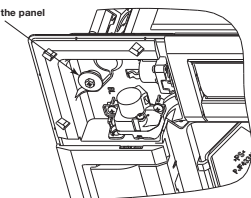

Caution

Do not give any stress on the panel when adjusting the height of the indoor unit to avoid unexpected distortion. It may cause the distortion of panel or failing to close the inlet grille, and the parts of the draft prevention mechanism.

⑧ Electrical wiring

The wiring work varies depending on the panel type. Select the wiring work appropriate for the panel type.

<For the standard panel>

- ① Connect the connector of the lower motor wiring (Wiring color: Red, Black) at the panel side to the connector CnJ3 (20 P, White) of the lower motor wiring (Wiring color: Red, Black) at the unit side.

For the Standard panel

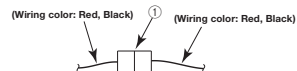
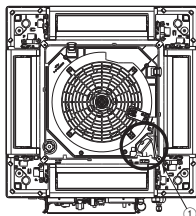

<For the draft prevention panel>

- ① Connect the connector of the lower motor wiring (Wiring color: Red, Black) at the panel side to the connector CnJ3 (20 P, White) of the lower motor wiring (Wiring color: Red, Black) at the unit side.
- ② Connect the connector of the air flex motor wiring (Wiring color: Blue, White) at the panel side to the connector CnJ4 (20 P, White) of the air flex motor wiring (Wiring color: Blue, White) at the unit side.

For the Draft prevention panel

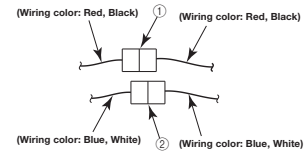
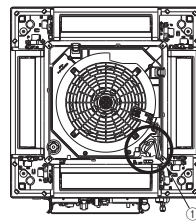

Motor wiring connection - Detail view

Install the wiring cover with care not to pinch wiring, and fix it with screws.

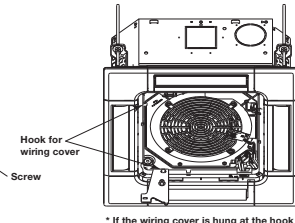
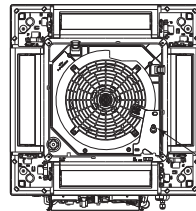

* If the wiring cover is hung at the hook on panel, it will become easier to work.

⑨ Installing a corner lid

1. To avoid unexpected falling of the corner lid, put the strap onto the corner lid's pin with turning the strap up.
2. Then hang the strap of a corner lid onto the panel's pin.
3. Hook the corner lid claws at 3 places, and fix the corner lid with attached screws.

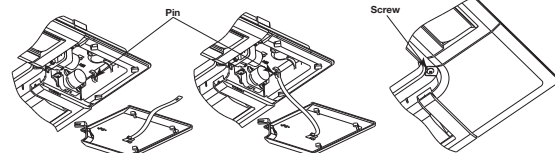

⑩ Installing the inlet grille

The panel and the inlet grille have no directional limitation to install. (Hinges of the inlet grille can be hooked at any side.)

Install the inlet grille in the reverse order of the steps described at **④ Removing the inlet grille**.

- ① Attach the fall grille hook to the panel.
- ② Insert the hinges of inlet grille in the insert holes on the panel. Close then the inlet grille while pressing the stoppers (2 places). Confirm that both stoppers are inserted securely in the panel.

<① Installation of the grille hook>

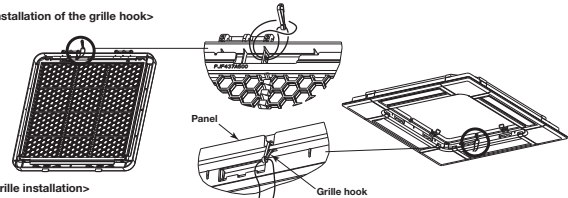

<② Grille installation>

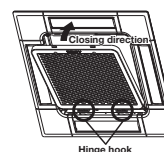

Caution

- Install the grille hook securely at the panel.
- The inlet grille must be installed starting from the hinge side.
- Install the inlet grille securely. It may drop if it is installed insecurely.
- When the stoppers have been deformed or damaged, repair them immediately. Unless they are repaired properly, the inlet grille may drop off.

⑪ Panel setting

<Louver swing range setting (Individual louver control setting)>

It is possible to change the swing range of the louver by the wired remote control. Once the upper and lower limit positions are set, the louver will swing within the set range. It is also possible to set the different range to each louver.

<Draft prevention setting>

The draft prevention function will not be operated if the draft prevention panel is installed and its wirings are only connected. To operate the draft prevention function, enable the draft prevention setting by using the wired or wireless remote control.

Note: It is not possible to set by the following remote control models or older.

- Wired: RC-EX3, RC-E5, RCH-E3
- Wireless: RCN-E1R

Once you have enabled the settings in this mode, the draft prevention function is operated when the air-conditioner is started, and the parts of the draft prevention mechanism are always open when the air-conditioner is operating. When the air-conditioner is stopped, they are closed. It is possible to enable or disabled the draft prevention function for each air outlet.

For the setting details, refer to the user's manual supplied with the remote control.

FRESH AIR INTAKE (Location for installation) FOR FDTC

At the time of installation use the duct hole (cut out) located at the positions shown in following diagram, as and when required.

(1) Temperature conditions for OA spacer ⁽¹⁾

- Adjust the temperature conditions of mixed air with outdoor air and indoor air within the usage range of suction air temperature for the air-conditioner.
- The usage temperature conditions of intake outdoor air and indoor air around the ducts are shown in the following table.
- If the temperature conditions of intake outdoor air do not meet, process the outdoor air before intaking.

Operation mode	Usage temperature conditions	
	Intake outdoor air	Indoor air around the ducts
In heating	5°C DB or higher	18.5°C WB or lower and 60% RH or lower
In cooling	29°C DB or lower and 80% RH or lower	20°C DB or higher

Note(1) : For the OA spacer, refer to page 199.

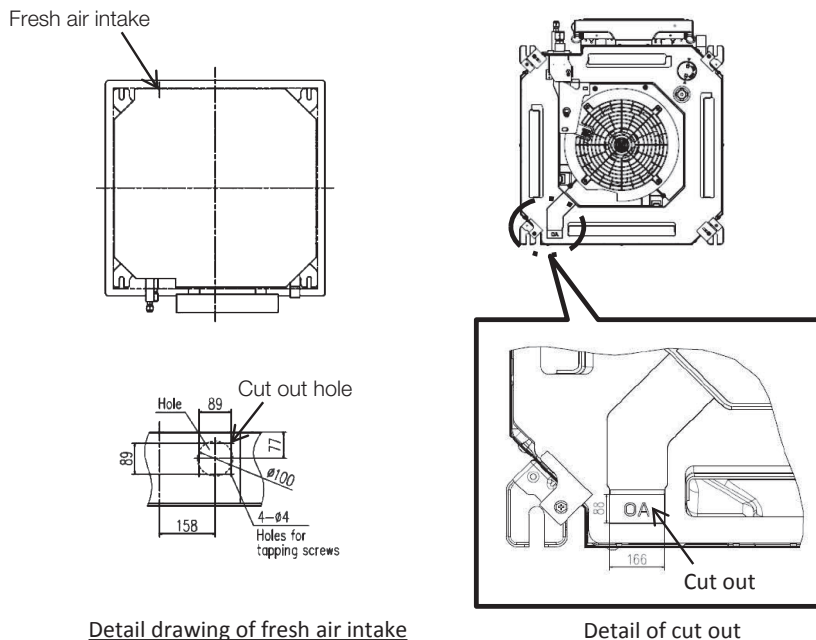

Detail drawing of fresh air intake

Detail of cut out

■ Fresh air intake amount & static pressure characteristics

FDTC40VH

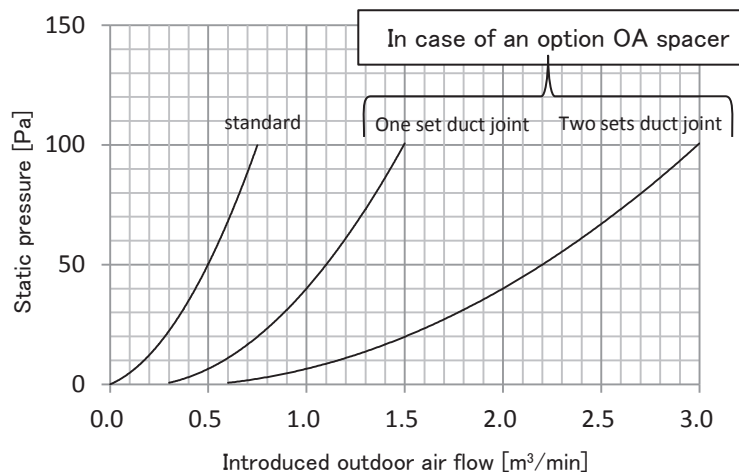

CHARACTERISTICS OF AIR FLOW IN DIVIDED DUCT FOR FDTC

Model FDTC40VH

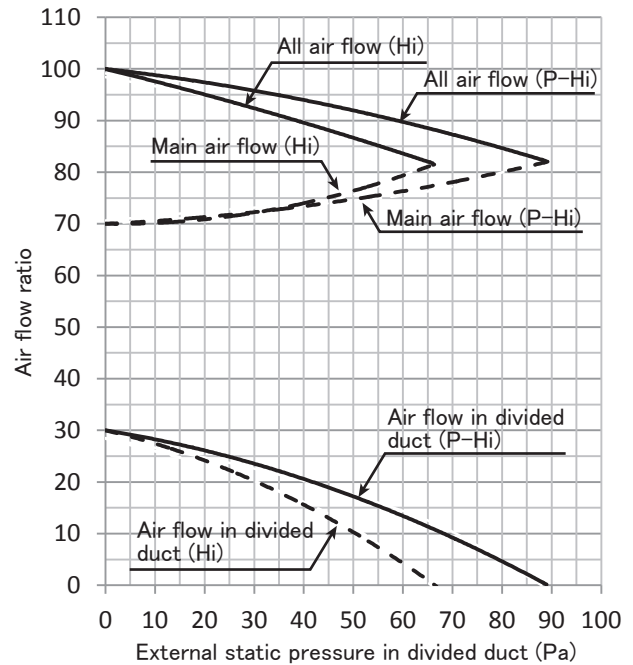
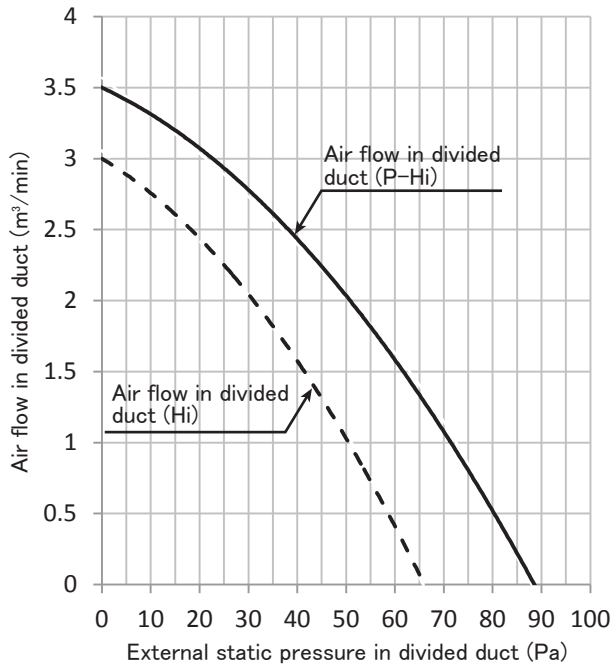

■ Divided duct connection method

1. Open some one during 4 knock out holes, and please connect a divided duct.

It isn't possible to use more than one hole at the same time.

2. Please make the wind shielding a blowout vent or the side where a divided duct was connected.
3. The shortage of the external static pressure by pressure loss for a connected divided duct and blowout unit is made up by a booster fan.

example : When 2.5m³/min of ventilation by divided duct is needed in model FDTC40VH (In case of connection duct ϕ 125 x 5m)

① Duct resistance : Pressure loss by a flexible duct = 35Pa (7Pa/m x 5m)

② Blowout unit : Pressure loss by a blowout unit = 10Pa

③ External static pressure when being 2.5m³/min = 17Pa (See upper table.)

⇒ Correspondence by a booster fan = ① + ② - ③ = 28Pa

(3) Duct connected-High static pressure type (FDU)

PJG012D022



(a) Indoor unit

- This manual is for installation of an indoor unit and an outdoor air processing unit (FDU-F).
- This manual is for the installation of an indoor unit.
- For electrical wiring work (Indoor), refer to page 91. For remote control installation, refer to page 95. For wireless kit installation, refer to page 157. For electrical wiring work (Outdoor) and refrigerant pipe work installation for outdoor unit, refer to page 107.



















The case of FDU-F

- The total connection capacity of the other air conditioning units and the outdoor air processing units must be from 50% to 100% (the total includes the outdoor air processing unit). The connection capacity of the outdoor air processing unit must not exceed 30% of the capacity of the outdoor unit.
- Single outdoor air processing unit can be used alone. The connection capacity of the outdoor air processing unit must be from 50% to 100% of the total capacity of the outdoor unit. Maximum number of outdoor air processing units that can be connected to the outdoor unit is 2units.
- Capacities of the suction air processing units can be calculated with the following formulas.
FDU650FKXE1 = 90, FDU1100FKXE1 = 140































SAFETY PRECAUTIONS

- Read the "SAFETY PRECAUTIONS" carefully first of all and then strictly follow it during the installation work in order to protect yourself.
- The precautionary items mentioned below are distinguished into two levels, **WARNING** and **CAUTION**.
WARNING: Wrong installation would cause serious consequences such as injuries or death.
CAUTION: Wrong installation might cause serious consequences depending on circumstances.
 Both mentions the important items to protect your health and safety so strictly follow them by any means.
- The meanings of "Marks" used here are as shown on the right:
 Never do it under any circumstances.  Always do it according to the instruction.
- After completing the installation, do commissioning to confirm there are no abnormalities, and explain to the customers about "SAFETY PRECAUTIONS", correct operation method and maintenance method (air filter cleaning, operation method and temperature setting method) with user's manual of this unit. Ask your customers to keep this installation manual together with the user's manual. Also, ask them to hand over the user's manual to the new user when the owner is changed.

WARNING

- **Installation should be performed by the specialist.**
If you install the unit by yourself, it may lead to serious trouble such as water leakage, electric shock, fire, and injury due to overturn of the unit. 
- **Install the system correctly according to these installation manuals.**
Improper installation may cause explosion, injury, water leakage, electric shock, and fire. 
- **Check the density referred by the formula (accordance with ISO5149).**
If the density exceeds the limit density, please consult the dealer and installate the ventilation system. 
- **Use the genuine accessories and the specified parts for installation.**
If parts unspecified by our company are used it could cause water leakage, electric shock, fire, and injury due to overturn of the unit. 
- **Ventilate the working area well in case the refrigerant leaks during installation.**
If the refrigerant contacts the fire, toxic gas is produced. In case of R32, the refrigerant could be ignited because of its flammability. 
- **Install the unit in a location that can hold heavy weight.**
Improper installation may cause the unit to fall leading to accidents. 
- **Install the unit properly in order to be able to withstand strong winds such as typhoons, and earthquakes.**
Improper installation may cause the unit to fall leading to accidents. 
- **Do not mix air in to the cooling cycle on installation or removal of the air-conditioner.**
If air is mixed in, the pressure in the cooling cycle will rise abnormally and may cause explosion and injuries. 
- **Be sure to have the electrical wiring work done by qualified electrical installer, and use exclusive circuit.**
Power source with insufficient capacity and improper work can cause electric shock and fire. 
- **Use specified wire for electrical wiring, fasten the wiring to the terminal securely, and hold the cable securely in order not to apply unexpected stress on the terminal.**
Loose connections or hold could result in abnormal heat generation or fire. 
- **Arrange the electrical wires in the control box properly to prevent them from rising. Fit the lid of the services panel properly.**
Improper fitting may cause abnormal heat and fire. 
- **Check for refrigerant gas leakage after installation is completed.**
If the refrigerant gas leaks into the house and comes in contact with a fan heater, a stove, or an oven, toxic gas is produced. 
- **Use the specified pipe, flare nut, and tools for R32 or R410A.**
Using existing parts (R22) could cause the unit failure and serious accident due to explosion of the cooling cycle. 
- **Tighten the flare nut according to the specified method by with torque wrench.**
If the flare nut were tightened with excess torque, it could cause burst and refrigerant leakage after a long period. 
- **Do not put the drainage pipe directly into drainage channels where poisonous gases such as sulfide gas can occur.**
Poisonous gases will flow into the room through drainage pipe and seriously affect the user's health and safety. This can also cause the corrosion of the indoor unit and a resultant unit failure or refrigerant leak. 
- **Connect the pipes for refrigeration circuit securely in installation work before compressor is operated.**
If the compressor is operated when the service valve is open without connecting the pipe, it could cause explosion and injuries due to abnormal high pressure in the system. 
- **Stop the compressor before removing the pipe after shutting the service valve on pump down work.**
If the pipe is removed when the compressor is in operation with the service valve open, air would be mixed in the refrigeration circuit and it could cause explosion and injuries due to abnormal high pressure in the cooling cycle. 
- **Only use prescribed option parts. The installation must be carried out by the qualified installer.**
If you install the system by yourself, it can cause serious trouble such as water leaks, electric shocks, fire. 
- **Do not repair by yourself. And consult with the dealer about repair.**
Improper repair may cause water leakage, electric shock or fire. 
- **Consult the dealer or a specialist about removal of the air-conditioner.**
Improper installation may cause water leakage, electric shock or fire. 
- **Turn off the power source during servicing or inspection work.**
If the power is supplied during servicing or inspection work, it could cause electric shock and injury by the operating fan. 
- **Do not run the unit when the panel or protection guard are taken off.**
Touching the rotating equipment, hot surface, or high voltage section could cause an injury to be caught in the machine, to get burned, or electric shock. 
- **Shut off the power before electrical wiring work.**
It could cause electric shock, unit failure and improper running. 

CAUTION

- **Perform earth wiring surely.**
Do not connect the earth wiring to the gas pipe, water pipe, lightning rod and telephone earth wiring. Improper earth could cause unit failure and electric shock or fire due to a short circuit. 
- **Earth leakage breaker must be installed.**
If the earth leakage breaker is not installed, it could cause electric shocks or fire. 
- **Use the circuit breaker of correct capacity. Circuit breaker should be the one that disconnect all poles under over current.**
Using the incorrect one could cause the system failure and fire. 
- **Do not use any materials other than a fuse of correct capacity where a fuse should be used.**
Connecting the circuit by wire or copper wire could cause unit failure and fire. 
- **Do not install the indoor unit near the location where there is possibility of flammable gas leakages.**
If the gas leaks and gathers around the unit, it could cause fire. 
- **Do not install and use the unit where corrosive gas (such as sulfurous acid gas etc.) or flammable gas (such as thinner, petroleum etc.) may be generated or accumulated, or volatile flammable substances are handled.**
It could cause the corrosion of heat exchanger, breakage of plastic parts etc. And inflammable gas could cause fire. 
- **Secure a space for installation, inspection and maintenance specified in the manual.**
Insufficient space can result in accident such as personal injury due to falling from the installation place. 
- **Do not use the indoor unit at the place where water splashes such as laundry.**
Indoor unit is not waterproof. It could cause electric shock and fire. 
- **Do not use the indoor unit for a special purpose such as food storage, cooling for precision instrument, preservation of animals, plants, and a work of art.**
It could cause the damage of the items. 
- **Do not install nor use the system near equipments which generate electromagnetic wave or high harmonics.**
Equipments like inverter equipment, private power generator, high-frequency medical equipment, or telecommunication equipment might influence the air-conditioner and cause a malfunction and breakdown. Or the air-conditioner might influence medical equipments or telecommunication equipments, and obstruct their medical activity or cause jamming. 
- **Do not install the remote control at the direct sunlight.**
It could cause breakdown or deformation of the remote control. 
- **Do not install the indoor unit at the place listed below.**
 - Places where flammable gas could leak.
 - Places where carbon fiber, metal powder or any powder is floated.
 - Place where the substances which affect the air-conditioner are generated such as sulfide gas, chloride gas, acid, alkali or ammoniac atmospheres.
 - Places exposed to oil mist or steam directly.
 - On vehicles and ships
 - Places where machinery which generates high harmonics is used.
 - Places where cosmetics or special sprays are frequently used.
 - Highly salted area such as beach.
 - Heavy snow area
 - Places where the system is affected by smoke from a chimney.
 - Altitude over 1000m
- **Do not install the indoor unit in the locations listed below (Be sure to install the indoor unit according to the installation manual for each model because each indoor unit has each limitation)**
 - Locations with any obstacles which can prevent inlet and outlet air of the unit
 - Locations where vibration can be amplified due to insufficient strength of structure.
 - Locations where the infrared receiver is exposed to the direct sunlight or the strong light beam. (in case of the infrared specification unit)
 - Locations where an equipment affected by high harmonics is placed. (TV set or radio receiver is placed within 5m)
 - Locations where drainage cannot run off safely.
 - Locations where the motion sensor at following places. It could cause deflection error, incapacity of detection, or characteristic degradation.
 - Place where vibration is applied to it for a long period of time.
 - Place where static electricity or electromagnetic wave generates.
 - Place where it is exposed to high temperature or humidity for a long period of time.
 - Dusty place or where the lens face could be fouled or damaged.
- **Do not put any valuables which will break down by getting wet under the air-conditioner.**
Condensation could drop when the relative humidity is higher than 80% or drain pipe is clogged, and it damages user's belongings. 
- **Do not use the base frame for the outdoor unit which is corroded or damaged after a long period of use.**
It could cause the unit falling down and injury. 
- **Pay attention not to damage the drain pan by weld sputter when brazing work is done near the unit.**
If sputter entered into the unit during brazing work, it could cause damage (pinhole) of drain pan and leakage of water. To avoid damaging, keep the indoor unit packed or cover the indoor unit. 
- **Install the drain pipe to drain the water surely according to the installation manual.**
Improper connection of the drain pipe may cause dropping water into room and damaging user's belongings. 
- **Do not share the drain pipe for indoor unit and GHP (Gas Heat Pump system) outdoor unit.**
Toxic exhaust gas would flow into room and it might cause serious damage (some poisoning or deficiency of oxygen) to user's health and safety. 
- **Be sure to perform air tightness test by pressurizing with nitrogen gas after completed refrigerant piping work.**
If the density of refrigerant exceeds the limit in the event of refrigerant leakage in the small room, lack of oxygen can occur, which can cause serious accidents. 
- **For drain pipe installation, be sure to make descending slope of greater than 1/100, not to make traps, and not to make air-bleeding.**
Check if the drainage is correctly done during commissioning and ensure the space for inspection and maintenance. 
- **Ensure the insulation on the pipes for refrigeration circuit so as not to condense water.**
Incomplete insulation could cause condensation and it would wet ceiling, floor, and any other valuables. 
- **Do not install the outdoor unit where is likely to be a nest for insects and small animals.**
Insects and small animals could come into the electronic components and cause breakdown and fire. Instruct the user to keep the surroundings clean. 
- **Pay extra attention, carrying the unit by hand.**
Carry the unit with 2 people if it is heavier than 20kg. Do not use the plastic straps but the grabbing place, moving the unit by hand. Use protective gloves in order to avoid injury by the aluminum fin. 
- **Make sure to dispose of the packaging material.**
Leaving the materials may cause injury as metals like nail and woods are used in the package. 
- **Do not operate the system without the air filter.**
It may cause the breakdown of the system due to clogging of the heat exchanger. 
- **Do not touch any button with wet hands.**
It could cause electric shock. 
- **Do not touch the refrigerant piping with bare hands when in operation.**
The pipe during operation would become very hot or cold according to the operating condition, and it could cause a burn or frostbite. 
- **Do not clean up the air-conditioner with water.**
It could cause electric shock. 
- **Do not turn off the power source immediately after stopping the operation.**
Be sure to wait for more than 5 minutes. Otherwise it could cause water leakage or breakdown. 
- **Do not control the operation with the circuit breaker.**
It could cause fire or water leakage. In addition, the fan may start operation unexpectedly and it may cause injury. 

○ This model is high static ducted type air-conditioning unit. Therefore, do not use this model for direct blow type air-conditioning unit.

1 Before installation

- Install correctly according to the installation manual.
- Confirm the following points:
 - Unit type/Power source specification
 - Pipes/Wires/Small parts
 - Accessory items

Accessory item

For hanging		For refrigerant pipe				For drain pipe			Elbow (Multi only)
Flat washer (M10)	Pipe cover (big)	Pipe cover (small)	Strap	Pipe cover (big)	Pipe cover (small)	Drain hose	Hose clamp		
8	1	1	4	1	1	1	1	1	
For unit hanging	For heat insulation of gas pipe	For heat insulation of liquid tube	For pipe cover fixing	For heat insulation of drain socket	For heat insulation of drain socket	For drain pipe connecting	For drain hose mounting	For drain pipe connecting	

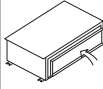

Accessory parts are stored inside this suction side.

2 Selection of installation location for the indoor unit

- Select the suitable areas to install the unit under approval of the user.
 - Areas where the indoor unit can deliver hot and cold wind sufficiently. Suggest to the user to use a circulator if the ceiling height is over 3m to avoid warm air being accumulated on the ceiling.
 - Areas where there is enough space to install and service.
 - Areas where it can be drained properly. Areas where drain pipe descending slope can be taken.
 - Areas where there is no obstruction of air flow on both air return grille and air supply port.
 - Areas where fire alarm will not be accidentally activated by the air-conditioner.
 - Areas where the supply air does not short-circuit.
 - Areas where it is not influenced by draft air.
 - Areas not exposed to direct sunlight.
 - Areas where dew point is lower than around 28°C and relative humidity is lower than 80%.

This indoor unit is tested under the condition of JIS (Japan Industrial Standard) high humidity condition and confirmed there is no problem. However, there is some risk of condensation drop if the air-conditioner is operated under the severer condition than mentioned above. If there is a possibility to use it under such a condition, attach additional insulation of 10 to 20mm thick for entire surface of indoor unit, refrigeration pipe and drain pipe.
 - Areas where TV and radio stays away more than 1m. (It could cause jamming and noise.)
 - Areas where any items which will be damaged by getting wet are not placed such as food, table wares, server, or medical equipment under the unit.
 - Areas where there is no influence by the heat which cookware generates.
 - Areas where not exposed to oil mist, powder and/or steam directly such as above fryer.
 - Areas where lighting device such as fluorescent light or incandescent light doesn't affect the operation. (A beam from lighting device sometimes affects the infrared receiver for the wireless remote control and the air-conditioner might not work properly.)
- Check if the place where the air-conditioner is installed can hold the weight of the unit. If it is not able to hold, reinforce the structure with boards and beams strong enough to hold it. If the strength is not enough, it could cause injury due to unit falling.

Space for installation and service

- Make installation altitude over 2.5m. (Indoor Unit)
- Select either of two cases to keep space for installation and services.

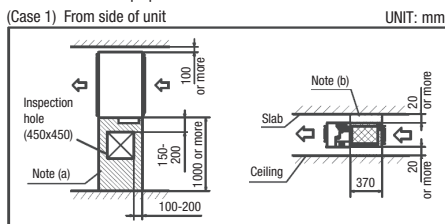

Notes (a) There must not be obstacle to draw out fan motor. (b) Install refrigerant pipe, drain pipe, and wiring so as not to cross marked area.

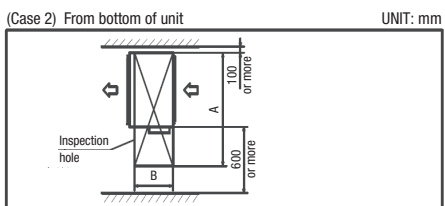

(Size of inspection hole)		UNIT: mm		
Single type	—	71	100-140	
Multi type	45, 56	71, 90	112-160	
FDU-F	—	650	1100	
A	1100	1300	1720	
B	620	725		

3 Cautions for the handling and installation place of outdoor air processing unit

- This unit monitors the outdoor air temperature at the position of sensor A in the figure, and controls the start and stop with the thermostat based on the value of sensor A and the setting temperature by the remote control.

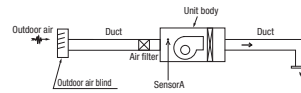

Remote control's setting temperature indicates the outdoor air temperature that controls the start and stop of operation by the thermostat.

When the thermostat is turned off, the operation is changed to the fan mode so that the outdoor air is blown out directly into the room. For example if the remote control is set to 22°C in cooling operation, and if the outdoor air temperature is 22°C or lower at that time, the unit will go into fan operation.

- Since there is a difference between the air-conditioning temperature in the room during cooling operation and the temperature of air blown out from the outdoor air processing unit, dewing water may drip from the unit. To prevent the dewing, provide a sufficient heat insulation means at the air blow outlet.
 - Since the air blow outlet on the outdoor air processing unit may blow out the outdoor air directly, orient the outlet in such a way that it will not blow air directly to persons in the room.
 - Since the unit controls the thermostat start and stop by monitoring the outdoor air temperature, it is prohibited to monitor the room temperature by means of the room temperature monitoring by changing the thermostat setting at the remote control side and the option remote temperature sensor. Otherwise, dewing water may drip from the unit at lower outdoor air temperatures during cooling operation.
 - Install the remote control of the outdoor air processing unit at a place closer to the administrator to avoid the end user from using the remote control.
- When handing over the unit to the end user, make sure to explain sufficiently about the foregoing cautions, the installation place of the remote control for the outdoor air processing unit and the position of air blow outlet.

4 Preparation before installation

- If suspension bolt becomes longer, do reinforcement of earthquake resistant.
 - For grid ceiling
 - When the suspension bolt length is over 500mm, or the gap between the ceiling and roof is over 700mm, apply earthquake resistant brace to the bolt.
 - In case the unit is hanged directly from the slab and is installed on the ceiling plane which has enough strength.
 - When suspension bolt length is over 1000mm, apply the earthquake resistant brace to the bolt.
- Prepare four (4) sets of suspension bolt, nut and spring washer (M10) on site.

Suspension Bolt Location

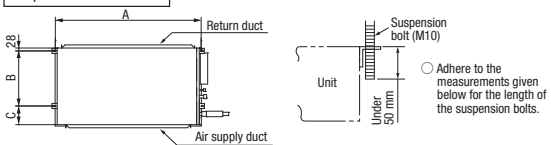

	UNIT: mm		
Single type	—	71	100-140
Multi type	45, 56	71, 90	112-160
FDU-F	—	650	1100
A	786	986	1720
B	472	472	725
C	135	135	180

Pipe locations

Single type	71
Multi type	45-90
FDU-F	650

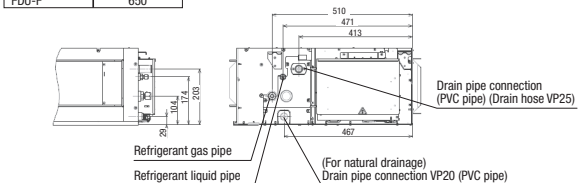

Single type	100-140
Multi type	112-160
FDU-F	1100

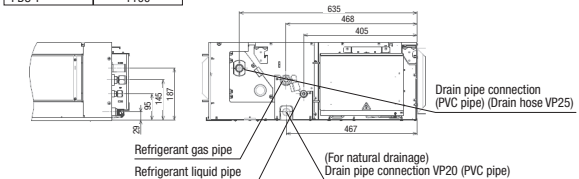

⑤ Installation of indoor unit

Work procedure

1. Prepare a hole of specified size on the ceiling.
2. Install suspension bolts at specified positions.
3. Make sure to use four suspension bolts.
4. Adjust the indoor unit position in order to fit with it.
5. Make sure to install the indoor unit horizontally. Confirm the levelness of the indoor unit with a level gauge or transparent hose filled with water. Keep the height difference at both ends of the indoor unit within 3mm.
6. Tighten four upper nuts and fix the unit after height and levelness adjustment.

Installation

[Hanging]

Hang the unit up.

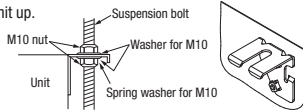

If the measurements between the unit and the ceiling hole do not match upon installation, it may be adjusted with the long holed installation tool.

Adjustment for horizontality

○ Either use a level vial, or adjust the level according to the method below.

- Adjust so the bottom side of the unit will be leveled with the water surface as illustrated below.

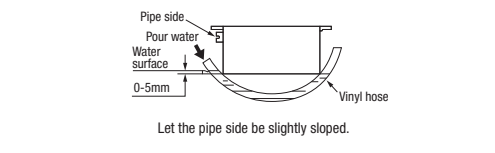

○ If the unit is not leveled, it may cause malfunctions or inoperation of the float switch.

⑥ Duct Work

- ① A corrugated board (for preventing spluttering) is attached to the main body of the air-conditioner (on the outlet port). Do not remove it until connecting the duct.

- An air filter can be provided on the main body of the air-conditioner (on the inlet port). Remove it when connecting the duct on the inlet port.

② Blowout duct

- Use rectangular duct to connect with unit.
- Duct size for each unit is as shown below.

		UNIT: mm		
Single type	—	71	100-140	
Multi type	45, 56	71, 90	112-160	
FDU-F	—	650	1100	
A	682	882	1202	
B	172	172	172	

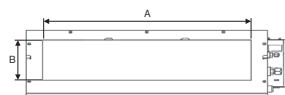

- Duct should be at their minimum length.
- We recommend to use sound and heat insulated duct to prevent it from condensation.
- Connect duct to unit before ceiling attachment.

③ Inlet port

- When connecting the duct to the inlet port, remove the air filter if it is fitted to the inlet port.
- Inlet port size for each unit is as shown below.

		UNIT: mm		
Single type	-	71	100-140	
Multi Type	45, 56	71, 90	112-160	
FDU-F	-	650	1100	
A	582	742	1282	
B	202	202	237	



- Make sure to insulate the duct to prevent dewing on it.

- ④ Install the specific blowout duct in a location where the air will circulate to the entire room.

- Conduct the installation of the specific blowout hole and the connection of the duct before attaching them to the ceiling.
- Insulate the area where the duct is secured by a band for dew condensation prevention.

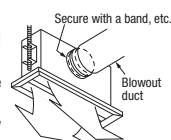

- ⑤ Make sure provide an inspection hole on the ceiling. It is indispensable to service electric equipment, motor, functional components and cleaning of heat exchanger.

⑥ Duct Work (continued)

- ⑥ Make sure to insulate ducts, in order to prevent dewing on them.

- ⑦ Connect the duct with care not to touch the blower (fan motor) with fingers. Or, when inhaling air directly from the suction side, install an air filter at the air suction inlet.

FDU

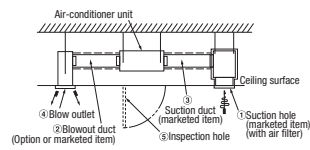

FDU-F

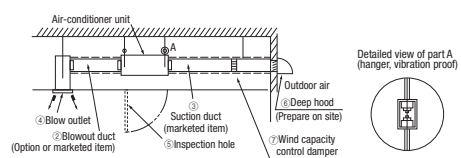

Bad example of duct work

- ① If a duct is not provided at the suction side but it is substituted with the space over the ceiling, humidity in the space will increase by the influence of capacity of ventilation fan, strength of wind blowing against the outdoor air louver, weather (rainy day) and others.
 - a) Moisture in air is likely to condense over the external plates of the unit and to drip on the ceiling. Unit should be operated under the conditions as listed in the above table and within the limitation of wind volume. When the building is a concrete structure, especially immediately after the construction, humidity tends to rise even if the space over the ceiling is not substituted in place of a duct. In such occasion, it is necessary to insulate the entire unit with glass wool (25mm). (Use a wire net or equivalent to hold the glass wool in place.)
 - b) It may run out the allowable limit of unit operation (Example, the case of FDU: When outdoor air temperature is 35°CDB, suction air temperature is 27°CWB) and it could result in such troubles as compressor overload, etc..
 - c) There is a possibility that the blow air volume may exceed the allowable range of operation due to the capacity of ventilation fan or strength of wind blowing against external air louver so that drainage from be heat exchanger may fall to reach the drain pan but leak outside (Example: drip on to the ceiling) with consequential water leakage in the room.
- ② If vibration damping is not conducted between the unit and the duct, and between the unit and the slab, vibration will be transmitted to the duct and vibration noise may occur. Also, vibration may be transmitted from the unit to the slab. Vibration damping must be performed.

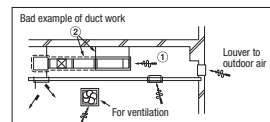

Connecting the air intake/vent ducts the case of FDU

- ① Fresh Air Intake (for air intake duct only)
 - Use the side fresh air intake hole, or supply through a part of the suction duct.

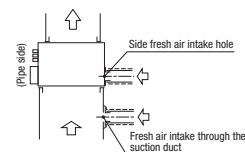

- [for simultaneous air intake/vent]
- Intake air through the suction duct. (the side cannot be used)

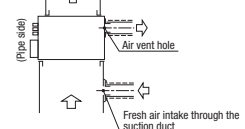

- ② Air Vent
 - Use the side air vent hole. (always use together with the air intake)



- Insulate the duct to protect it from dew condensation.

⑦ Refrigerant pipe

Caution

- Be sure to use new pipes for the refrigerant pipes. Use the flare nut attached to the product. Regarding whether existing pipes can be reused or not, and the washing method, refer to the instruction manual of the outdoor unit, catalogue or technical data.
 - 1) In case of reuse: Do not use old flare nut, but use the one attached to the unit.
 - 2) In case of reuse: Flare the end of pipe replaced partially for R32 or R410A.

⚠ WARNING : When flared joints are reused indoors, the flare part shall be re-fabricated. (only for R32)

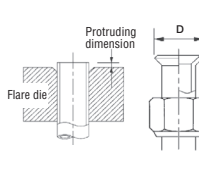

Pipe dia. d mm	Min. pipe wall thickness mm	Protruding dimension for flare, mm		Flare O.D. D mm	Flare nut tightening torque N·m
		Rigid (Clutch type) For R32 For R410A	Conventional bot		
6.35	0.8	0 - 0.5	0.7 - 1.3	8.9 - 9.1	14 - 18
9.52	0.8			12.8 - 13.2	34 - 42
12.7	0.8			16.2 - 16.6	49 - 61
15.88	1			19.3 - 19.7	68 - 82
19.05	1.2			23.6 - 24.0	100 - 120

- Use phosphorus deoxidized copper alloy seamless pipe (C1220T) for refrigeration pipe installation. In addition, make sure there is no damage both inside and outside of the pipe, and no harmful substances such as sulfur, oxide, dust or a contaminant stuck on the pipes.
- Do not use any refrigerant other than R32 or R410A. Using other refrigerant except R32 or R410A (R22 etc.) may degrade inside refrigeration oil. And air getting into refrigeration circuit may cause over-pressure and resultant it may result in bursting, etc.
- Store the copper pipes indoors and seal the both end of them until they are brazed in order to avoid any dust, dirt or water getting into pipe. Otherwise it will cause degradation of refrigeration oil and compressor breakdown, etc.
- Use special tools for R32 or R410A refrigerant.

Piping work

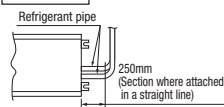

When conducting piping work, make sure to allow the pipes to be aligned in a straight line for at least 250 mm, as shown in the left illustration. (This is necessary for the drain pump to function)

Work procedure

1. Remove the flare nut and blind flanges on the pipe of the indoor unit.
 - ※ Make sure to loosen the flare nut with holding the nut on pipe side with a spanner and giving torque to the nut with another spanner in order to avoid unexpected stress to the copper pipe, and then remove them. (Gas may come out at this time, but it is not abnormal.)
 - Pay attention whether the flare nut pops out. (as the indoor unit is sometimes pressured.)
2. Make a flare on liquid pipe and gas pipe, and connect the refrigeration pipes on the indoor unit.
 - ※ Bend radius of pipe must be 4D or larger. Once a pipe is bent, do not readjust the bending. Do not twist a pipe or collapse to 2/3D or smaller.
 - Make sure to use flare nuts assembled on the unions. Usage of other flare nuts could cause refrigerant leakage.
 - ※ Do a flare connection as follows:
 - Make sure to hold the nut on indoor unit pipe side using double spanner method as indicated when fastening / loosening flare nuts in order to prevent unintentional twisting of the copper pipe.
 - When fastening the flare nut, align the refrigeration pipe with the center of flare nut, screw the nut for 3-4 times by hand and then tighten it by spanner with the specified torque mentioned in the table above.
3. Cover the flare connection part of the indoor unit with attached insulation material after a gas leakage inspection, and tighten both ends with attached straps.
 - Make sure to insulate both gas pipes and liquid pipes completely.
 - ※ Incomplete insulation may cause dew condensation or water dropping.
 - Use heat-resistant (120 °C or more) insulations on the gas side pipes.
 - In case of using at high humidity condition, reinforce insulation of refrigerant pipes. Surface of insulation may cause dew condition or water dropping, if insulations are not reinforced.
4. Refrigerant is charged in the outdoor unit. As for the additional refrigerant charge for the indoor unit and piping, refer to the installation manual attached to the outdoor unit.

Caution:

Refrigerating machine oil should not be applied to the threads of union or external surface of flare. It is because, even if the same tightening torque is applied, the oil is likely to decrease the slide friction force on the threads and increase, in turn, the axial component force so that it could crack the flare by the stress corrosion. Refrigerating machine oil may be applied to the internal surface of flare only.

<The case of using thickness of insulation is 10mm>

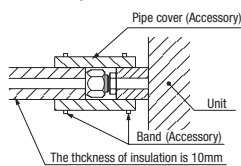

<The case of using reinforced insulation>

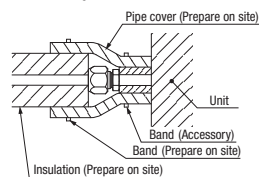

⑧ Drain pipe

Caution

- Install the drain pipe according to the installation manual in order to drain properly. Imperfection in draining may cause flood indoors and wetting the household goods, etc.
- Do not put the drain pipe directly into the ditch where toxic gas such as sulfur, the other harmful and inflammable gas is generated. Toxic gas would flow into the room and it would cause serious damage to user's health and safety (some poisoning or deficiency of oxygen). In addition, it may cause corrosion of heat exchanger and bad smell.
- Connect the pipe securely to avoid water leakage from the joint.
- Insulate the pipe properly to avoid condensation drop.
- Check if the water can flow out properly from both the drain outlet on the indoor unit and the end of the drain pipe after installation.
- Make sure to make descending slope of greater than 1/100 and do not make up-down bend and/or trap in the midway. In addition, do not put air vent on the drain pipe. Check if water is drained out properly from the pipe during commissioning. Also, keep sufficient space for inspection and maintenance.

Work procedure

1. Make sure to insert the drain hose (the end made of soft PVC) to the end of the step part of drain socket. Attach the hose clamp to the drain hose around 10mm from the end, and fasten the screw about 5mm left to the nut.
 - Do not apply adhesives on this end.
 - Do not use acetone-based adhesives to connect to the drain socket.

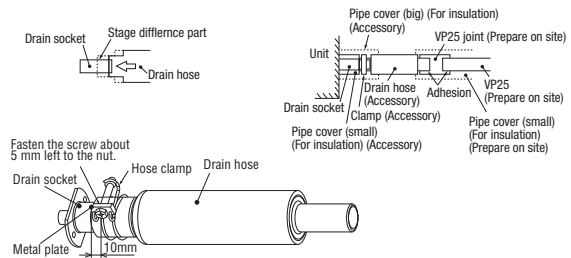

2. Prepare a joint for connecting VP25 pipe, adhere and connect the joint to the drain hose (the end made of rigid PVC), and adhere and connect VP25 pipe (prepare on site).
 - ※ As for drain pipe, apply VP25 made of rigid PVC which is on the market.
 - Make sure that the adhesive will not get into the supplied drain hose. It may cause the flexible part broken after the adhesive is dried up and gets rigid.
 - The flexible drain hose is intended to absorb a small difference at installation of the unit or drain pipes. Intentional bending, expanding may cause the flexible hose broken and water leakage.

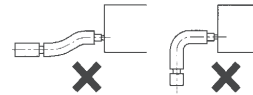

- As for drain pipe, apply VP25 (OD32). If apply PVC25 (OD25), connect the expanded connector to the drain hose, with adhesive. (Multi unit only)

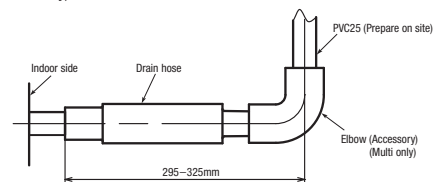

3. Make sure to make descending slope of greater than 1/100 and do not make up-down bend and/or trap in the midway.
 - Pay attention not to give stress on the pipe on the indoor unit side, and support and fix the pipe as close place to the unit as possible when connecting the drain pipe.
 - Do not set up air vent.

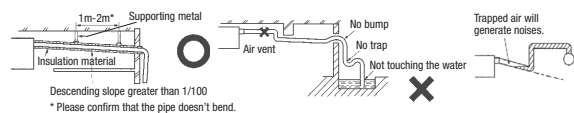

Descending slope greater than 1/100
* Please confirm that the pipe doesn't bend.

- When sharing a drain pipe for more than one unit, lay the main pipe 100mm below the drain outlet of the unit. In addition, select VP30 or bigger size for main drain pipe.

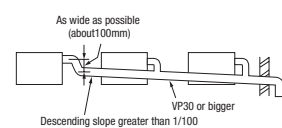

⑧ Drain pipe (continued)

4. Insulate the drain pipe.
 - Be sure to insulate the drain socket and rigid PVC pipe installed indoors otherwise it may cause dew condensation and water leakage.
 - ※ After drainage test implementation, cover the drain socket part with pipe cover (small size), then use the pipe cover (big size) to cover the pipe cover (small size), clamps and part of the drain hose, and fix and wrap it with tapes to wrap and make joint part gapless.

Drain up

- The position for drain pipe outlet can be raised up to 600mm above the ceiling. Use elbows for installation to avoid obstacles inside ceiling. If the horizontal drain pipe is too long before vertical pipe, the backflow of water will increase when the unit is stopped, and it may cause overflow of water from the drain pan on the indoor unit. In order to avoid overflow, keep the horizontal pipe length and offset of the pipe within the limit shown in the figure below.

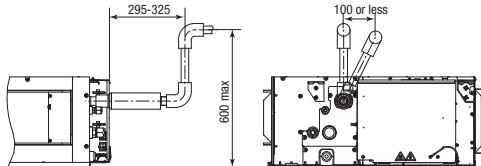

Otherwise, the construction point makes it same as drain pipe construction.

Drain test

1. Conduct a drain test after completion of the electrical work.
2. During the trial, make sure that drain flows properly through the piping and that no water leaks from connections.
3. In case of a new building, conduct the test before it is furnished with the ceiling.
4. Be sure to conduct this test even when the unit is installed in the heating season.

Procedures

1. Supply about 2000 cc of water to the unit through the air outlet by using a feed water pump.
2. Check the drain while cooling operation.

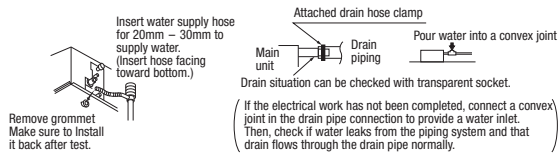

Outline of bottom drain piping work

- If the bottom drain piping can be done with a descending gradient (1/50-1/100), it is possible to connect the pipes as shown in the drawing below.

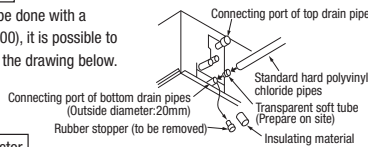

Uncoupling the drain motor connector

- Uncouple the connector CnR for the drain motor as illustrated in the drawing on the right.

(Note: If the unit is run with the connector coupled, drain water will be discharged from the upper drain pipe joint, causing a water leak.)

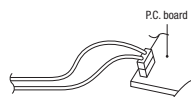

⑨ Wiring-out position and wiring connection

- Electrical installation work must be performed according to the installation manual by an electrical installation service provider qualified by a power provider of the country, and be executed according to the technical standards and other regulations applicable to electrical installation in the country. Be sure to use an exclusive circuit.
 - Use specified cord, fasten the wiring to the terminal securely, and hold the cord securely in order not to apply unexpected stress on the terminal.
 - Do not put both power source line and signal line on the same route. It may cause miscommunication and malfunction.
 - Be sure to do D type earth work.
 - For the details of electrical wiring work, see attached instruction manual for electrical wiring work.
1. Remove a lid of the control box (2 screws).
 2. Hold each wiring inside the unit and fasten them to terminal block securely.
 3. Fix the wiring with clamps.
 4. Install the removed parts back to original place.

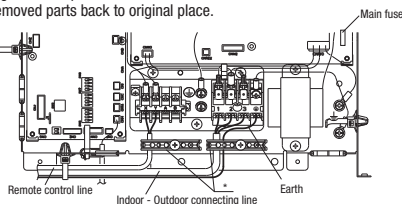

Single unit wiring connection

⑨ Wiring-out position and wiring connection (continued)

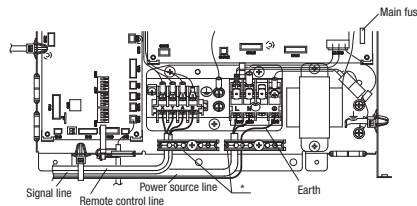

Multi unit wiring connection

Main fuse specification

Model	FDU-F	Specification	Part No.
45-90	650	T 5A L 250V	SSA564A149AH
112-160	1100	T 6.3A L 250V	SSA564A149AJ

* Please fix the wiring in the band not to move even if it pulls.

⑩ External static pressure setting

You can set External Static Pressure (E.S.P.) by method of MANUAL SETTING on remote control. Indoor unit will control fan-speed to keep rated air flow volume at each fan speed setting (Lo-P-Hi). You can set required E.S.P. by wired remote control that calculated with the set air flow rate and pressure loss of the duct connected.

- How to set E.S.P. by wired remote control
 - ① Push "◆" marked button (E.S.P. button).
 - ② Select indoor unit No. by using "◆" button.
 - ③ Select setting No. by using "◆" button and set E.S.P. by "□" button.



Notice

You can not set E.S.P. by wireless remote control.

With E.S.P. setting, confirm that actual E.S.P. agrees with E.S.P. setting. When E.S.P. setting is higher than actual E.S.P., the air flow rate becomes excessively higher. This will cause water leakage if water splashes. When E.S.P. setting is lower than actual E.S.P., the air flow rate becomes excessively lower and the cooling or heating may become ineffective. In order to reduce the risk above the factory E.S.P. setting is set within the range of 80 – 150 Pa (E.S.P. setting No. 8 – 15). Be sure to use within the range of 80 – 150 Pa in actual operations. If actual E.S.P. is lower than 80 Pa, it may cause water leakage.

Setting No.	8	9	10	11	12	13	14	15
E.S.P. (Pa)	80	90	100	110	120	130	140	150

- ※ If 1 – 7 is selected for the setting No. on the remote control, the setting No. shows No. 8.
- ※ If 16 – 20 is selected for the setting No. on the remote control, the setting No. shows No. 15.
- ※ Factory default is No. 8.

The Case of FDU-F

Setting No.	1	2	3	4	5	6	7	8	9	10	11	12
E.S.P. (Pa)	10	20	30	40	50	60	70	80	90	100	110	120

- ※ If 13-20 is selected for the setting No. on the remote control, the setting No. shows No. 12.
- ※ Factory default is No. 8.

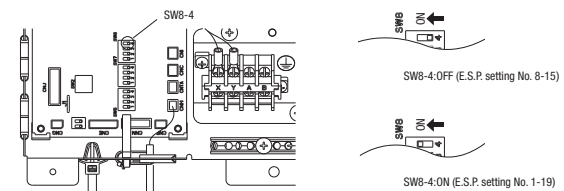

If SW8-4 is turned to "ON", E.S.P. setting range can be changed to 10 – 200 Pa (E.S.P. setting No. 1 – 19). This should not be used when actual E.S.P. cannot be confirmed, because the risk above becomes higher.

Setting No.	1	2	3	4	5	6	7	8	9	10	11	12	13	14	15	16	17	18	19
E.S.P. (Pa)	10	20	30	40	50	60	70	80	90	100	110	120	130	140	150	160	170	180	200

- ※ If 20 is selected for the setting No. on the remote control, the setting No. shows No. 19.

⑪ Check list after installation

- Check the following items after all installation work completed.

Check if	Expected trouble	Check
The indoor and outdoor units are fixed securely?	Falling, vibration, noise	Check
Inspection for leakage is done?	Insufficient capacity	
Insulation work is properly done?	Water leakage	
Water is drained properly?	Water leakage	
Power source voltage is same as mentioned in the model name plate?	PCB burnt out, not working at all	
No mis-wiring or mis-connection of piping?	PCB burnt out, not working at all	
Earth wiring is connected properly?	Electric shock	
Cable size comply with specified size?	PCB burnt out, not working at all	
Any obstacle blocks air flow on air inlet and outlet?	Insufficient capacity	
Is setting of E.S.P. finished?	Excessive air flow, water drop blow out	

(b) Replacement procedure of the fan unit

- Notes(1) The unit is a heavy item. It must be supported securely and handled with care not to drop when it is necessary to replace.
(2) For the maintenance space, refer to page 71.

Model FDU71VH

- 1) Remove the control box and the side panel, and remove the screws marked in the circles (2 places) in the figure.

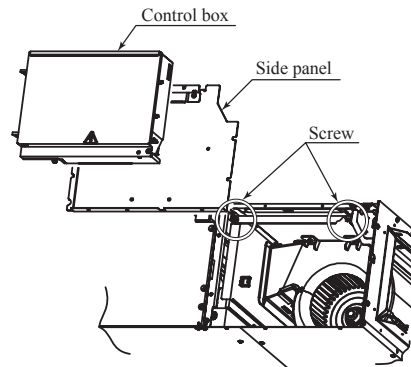

- 2) Take out the fan unit in the arrow direction.

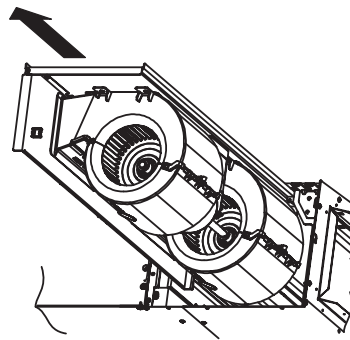

(4) Duct connected-Low/Middle static pressure type (FDUM)

PJG012D021

(a) Indoor unit

This manual is for the installation of an indoor unit.
For electrical wiring work (Indoor), refer to page 91. For remote control installation, refer to page 95. For wireless kit installation, refer to page 157. For electrical wiring work (Outdoor) and refrigerant pipe work installation for outdoor unit, refer to page 107.

SAFETY PRECAUTIONS

- Read the "SAFETY PRECAUTIONS" carefully first of all and then strictly follow it during the installation work in order to protect yourself.
- The precautionary items mentioned below are distinguished into two levels, [WARNING] and [CAUTION].
[WARNING]: Wrong installation would cause serious consequences such as injuries or death.
[CAUTION]: Wrong installation might cause serious consequences depending on circumstances. Both mentions the important items to protect your health and safety so strictly follow them by any means.
- The meanings of "Marks" used here are as shown on the right:
⊗ Never do it under any circumstances. ⊕ Always do it according to the instruction.
- After completing the installation, do commissioning to confirm there are no abnormalities, and explain to the customers about "SAFETY PRECAUTIONS", correct operation method and maintenance method (air filter cleaning, operation method and temperature setting method) with user's manual of this unit. Ask your customers to keep this installation manual together with the user's manual. Also, ask them to hand over the user's manual to the new user when the owner is changed.

⚠ WARNING

- **Installation should be performed by the specialist.** ⊕
If you install the unit by yourself, it may lead to serious trouble such as water leakage, electric shock, fire, and injury due to overturn of the unit.
- **Install the system correctly according to these installation manuals.** ⊕
Improper installation may cause explosion, injury, water leakage, electric shock, and fire.
- **Check the density referred by the formula (accordance with ISO5149).** ⊕
If the density exceeds the limit density, please consult the dealer and install the ventilation system.
- **Use the genuine accessories and the specified parts for installation.** ⊕
If parts unspecified by our company are used it could cause water leakage, electric shock, fire, and injury due to overturn of the unit.
- **Ventilate the working area well in case the refrigerant leaks during installation.** ⊕
If the refrigerant contacts the fire, toxic gas is produced.
In case of R32, the refrigerant could be ignited because of its flammability.
- **Install the unit in a location that can hold heavy weight.** ⊕
Improper installation may cause the unit to fall leading to accidents.
- **Install the unit properly in order to be able to withstand strong winds such as typhoons, and earthquakes.** ⊕
Improper installation may cause the unit to fall leading to accidents.
- **Do not mix air in to the cooling cycle on installation or removal of the air-conditioner.** ⊗
If air is mixed in, the pressure in the cooling cycle will rise abnormally and may cause explosion and injuries.
- **Be sure to have the electrical wiring work done by qualified electrical installer, and use exclusive circuit.** ⊕
Power source with insufficient capacity and improper work can cause electric shock and fire.
- **Use specified wire for electrical wiring, fasten the wiring to the terminal securely, and hold the cable securely in order not to apply unexpected stress on the terminal.** ⊕
Loose connections or hold could result in abnormal heat generation or fire.
- **Arrange the electrical wires in the control box properly to prevent them from rising. Fit the lid of the services panel properly.** ⊕
Improper fitting may cause abnormal heat and fire.
- **Check for refrigerant gas leakage after installation is completed.** ⊕
If the refrigerant gas leaks into the house and comes in contact with a fan heater, a stove, or an oven, toxic gas is produced.
- **Use the specified pipe, flare nut, and tools for R32 or R410A.** ⊕
Using existing parts (R22) could cause the unit failure and serious accident due to explosion of the cooling cycle.
- **Tighten the flare nut according to the specified method by with torque wrench.** ⊕
If the flare nut were tightened with excess torque, it could cause burst and refrigerant leakage after a long period.
- **Do not put the drainage pipe directly into drainage channels where poisonous gases such as sulfide gas can occur.** ⊗
Poisonous gases will flow into the room through drainage pipe and seriously affect the user's health and safety. This can also cause the corrosion of the indoor unit and a resultant unit failure or refrigerant leak.
- **Connect the pipes for refrigeration circuit securely in installation work before compressor is operated.** ⊕
If the compressor is operated when the service valve is open without connecting the pipe, it could cause explosion and injuries due to abnormal high pressure in the system.
- **Stop the compressor before removing the pipe after shutting the service valve on pump down work.** ⊕
If the pipe is removed when the compressor is in operation with the service valve open, air would be mixed in the refrigeration circuit and it could cause explosion and injuries due to abnormal high pressure in the cooling cycle.
- **Only use prescribed option parts. The installation must be carried out by the qualified installer.** ⊕
If you install the system by yourself, it can cause serious trouble such as water leaks, electric shocks, fire.
- **Do not repair by yourself. And consult with the dealer about repair.** ⊗
Improper repair may cause water leakage, electric shock or fire.
- **Consult the dealer or a specialist about removal of the air-conditioner.** ⊕
Improper installation may cause water leakage, electric shock or fire.
- **Turn off the power source during servicing or inspection work.** ⊕
If the power is supplied during servicing or inspection work, it could cause electric shock and injury by the operating fan.
- **Do not run the unit when the panel or protection guard are taken off.** ⊗
Touching the rotating equipment, hot surface, or high voltage section could cause an injury to be caught in the machine, to get burned, or electric shock.
- **Shut off the power before electrical wiring work.** ⊕
It could cause electric shock, unit failure and improper running.

⚠ CAUTION

- **Perform earth wiring surely.** ⊕
Do not connect the earth wiring to the gas pipe, water pipe, lightning rod and telephone earth wiring. Improper earth could cause unit failure and electric shock or fire due to a short circuit.
- **Earth leakage breaker must be installed.** ⊕
If the earth leakage breaker is not installed, it could cause electric shocks or fire.
- **Use the circuit breaker of correct capacity. Circuit breaker should be the one that disconnect all poles under over current.** ⊕
Using the incorrect one could cause the system failure and fire.
- **Do not use any materials other than a fuse of correct capacity where a fuse should be used.** ⊗
Connecting the circuit by wire or copper wire could cause unit failure and fire.
- **Do not install the indoor unit near the location where there is possibility of flammable gas leakages.** ⊗
If the gas leaks and gathers around the unit, it could cause fire.
- **Do not install and use the unit where corrosive gas (such as sulfurous acid gas etc.) or flammable gas (such as thinner, petroleum etc.) may be generated or accumulated, or volatile flammable substances are handled.** ⊗
It could cause the corrosion of heat exchanger, breakage of plastic parts etc. And inflammable gas could cause fire.
- **Secure a space for installation, inspection and maintenance specified in the manual.** ⊕
Insufficient space can result in accident such as personal injury due to falling from the installation place.
- **Do not use the indoor unit at the place where water splashes such as laundry.** ⊗
Indoor unit is not waterproof. It could cause electric shock and fire.
- **Do not use the indoor unit for a special purpose such as food storage, cooling for precision instrument, preservation of animals, plants, and a work of art.** ⊗
It could cause the damage of the items.
- **Do not install nor use the system near equipments which generate electromagnetic wave or high harmonics.** ⊗
Equipments like inverter equipment, private power generator, high-frequency medical equipment, or telecommunication equipment might influence the air-conditioner and cause a malfunction and breakdown. Or the air-conditioner might influence medical equipments or telecommunication equipments, and obstruct their medical activity or cause jamming.
- **Do not install the remote control at the direct sunlight.** ⊗
It could cause breakdown or deformation of the remote control.
- **Do not install the indoor unit at the place listed below.** ⊗
 - Places where flammable gas could leak.
 - Places where carbon fiber, metal powder or any powder is floated.
 - Place where the substances which affect the air-conditioner are generated such as sulfide gas, chlorine gas, acid, alkali or ammoniac atmospheres.
 - Places exposed to oil mist or steam directly.
 - On vehicles and ships
 - Places where machinery which generates high harmonics is used.
 - Places where cosmetics or special sprays are frequently used.
 - Highly salted area such as beach.
 - Heavy snow area
 - Places where the system is affected by smoke from a chimney.
 - Altitude over 1000m
- **Do not install the indoor unit in the locations listed below (Be sure to install the indoor unit according to the installation manual for each model because each indoor unit has each limitation)** ⊗
 - Locations with any obstacles which can prevent inlet and outlet air of the unit
 - Locations where vibration can be amplified due to insufficient strength of structure.
 - Locations where the infrared receiver is exposed to the direct sunlight or the strong light beam. (in case of the infrared specification unit)
 - Locations where an equipment affected by high harmonics is placed. (TV set or radio receiver is placed within 5m)
 - Locations where drainage cannot run off safely. It can affect performance or function and etc..
 - Do not install the motion sensor at following places. It could cause detection error, incapacity of detection, or characteristic degradation.
 - Place where vibration is applied to it for a long period of time.
 - Place where static electricity or electromagnetic wave generates.
 - Place where it is exposed to high temperature or humidity for a long period of time.
 - Dusty place or where the lens face could be fouled or damaged.
- **Do not put any valuables which will break down by getting wet under the air-conditioner.** ⊗
Condensation could drop when the relative humidity is higher than 80% or drain pipe is clogged, and it damages user's belongings.
- **Do not use the base frame for the outdoor unit which is corroded or damaged after a long period of use.** ⊗
It could cause the unit falling down and injury.
- **Pay attention not to damage the drain pan by weld sputter when brazing work is done near the unit.** ⊕
If sputter entered into the unit during brazing work, it could cause damage (pinhole) of drain pan and leakage of water. To avoid damaging, keep the indoor unit packed or cover the indoor unit.
- **Install the drain pipe to drain the water surely according to the installation manual.** ⊕
Improper connection of the drain pipe may cause dropping water into room and damaging user's belongings.
- **Do not share the drain pipe for indoor unit and GHP (Gas Heat Pump system) outdoor unit.** ⊗
Toxic exhaust gas would flow into room and it might cause serious damage (some poisoning or deficiency of oxygen) to user's health and safety.
- **Be sure to perform air tightness test by pressurizing with nitrogen gas after completed refrigerant piping work.** ⊕
If the density of refrigerant exceeds the limit in the event of refrigerant leakage in the small room, lack of oxygen can occur, which can cause serious accidents.
- **For drain pipe installation, be sure to make descending slope of greater than 1/100, not to make traps, and not to make air-bleeding.** ⊕
Check if the drainage is correctly done during commissioning and ensure the space for inspection and maintenance.
- **Ensure the insulation on the pipes for refrigeration circuit so as not to condense water.** ⊕
Incomplete insulation could cause condensation and it would wet ceiling, floor, and any other valuables.
- **Do not install the outdoor unit where is likely to be a nest for insects and small animals.** ⊗
Insects and small animals could come into the electronic components and cause breakdown and fire. Instruct the user to keep the surroundings clean.
- **Pay extra attention, carrying the unit by hand.** ⊕
Carry the unit with 2 people if it is heavier than 20kg. Do not use the plastic straps but the grabbing place, moving the unit by hand. Use protective gloves in order to avoid injury by the aluminum fin.
- **Make sure to dispose of the packaging material.** ⊕
Leaving the materials may cause injury as metals like nail and woods are used in the package.
- **Do not operate the system without the air filter.** ⊗
It may cause the breakdown of the system due to clogging of the heat exchanger.
- **Do not touch any button with wet hands.** ⊗
It could cause electric shock.
- **Do not touch the refrigerant piping with bare hands when in operation.** ⊗
The pipe during operation would become very hot or cold according to the operating condition, and it could cause a burn or frostbite.
- **Do not clean up the air-conditioner with water.** ⊗
It could cause electric shock.
- **Do not turn off the power source immediately after stopping the operation.** ⊗
Be sure to wait for more than 5 minutes. Otherwise it could cause water leakage or breakdown.
- **Do not control the operation with the circuit breaker.** ⊗
It could cause fire or water leakage. In addition, the fan may start operation unexpectedly and it may cause injury.

○ This model is middle static ducted type air conditioning unit. Therefore, do not use this model for direct blow type air conditioning unit.

① Before installation

- Install correctly according to the installation manual.
- Confirm the following points:
 - Unit type/Power source specification
 - Pipes/Wires/Small parts
 - Accessory items

Accessory item

For hanging	For refrigerant pipe			For drain pipe			
Flat washer (M10)	Pipe cover (big)	Pipe cover (small)	Strap	Pipe cover (big)	Pipe cover (small)	Drain hose	Hose clamp
8	1	1	4	1	1	1	1
For unit hanging	For heat insulation of gas pipe	For heat insulation of liquid tube	For pipe cover fixing	For heat insulation of drain socket	For heat insulation of drain socket	For drain pipe connecting	For drain hose mounting

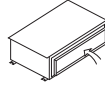

Accessory parts are stored inside this suction side.

② Selection of installation location for the indoor unit

- Select the suitable areas to install the unit under approval of the user.
 - Areas where the indoor unit can deliver hot and cold wind sufficiently. Suggest to the user to use a circulator if the ceiling height is over 3m to avoid warm air being accumulated on the ceiling.
 - Areas where there is enough space to install and service.
 - Areas where it can be drained properly. Areas where drain pipe descending slope can be taken.
 - Areas where there is no obstruction of air flow on both air return grille and air supply port.
 - Areas where fire alarm will not be accidentally activated by the air-conditioner.
 - Areas where the supply air does not short-circuit.
 - Areas where it is not influenced by draft air.
 - Areas not exposed to direct sunlight.
 - Areas where dew point is lower than around 28°C and relative humidity is lower than 80%.
 (This indoor unit is tested under the condition of JIS (Japan Industrial Standard) high humidity condition and confirmed there is no problem. However, there is some risk of condensation drop if the air-conditioner is operated under the severer condition than mentioned above. If there is a possibility to use it under such a condition, attach additional insulation of 10 to 20mm thick for entire surface of indoor unit, refrigerant pipe and drain pipe.)
 - Areas where TV and radio stays away more than 1m. (It could cause jamming and noise.)
 - Areas where any items which will be damaged by getting wet are not placed such as food, table wares, server, or medical equipment under the unit.
 - Areas where there is no influence by the heat which cookware generates.
 - Areas where not exposed to oil mist, powder and/or steam directly such as above fryer.
 - Areas where lighting device such as fluorescent light or incandescent light doesn't affect the operation.
 (A beam from lighting device sometimes affects the infrared receiver for the wireless remote control and the air conditioner might not work properly.)
- Check if the place where the air-conditioner is installed can hold the weight of the unit. If it is not able to hold, reinforce the structure with boards and beams strong enough to hold it. If the strength is not enough, it could cause injury due to unit falling.

Space for installation and service

- Make installation altitude over 2.5m.
(Indoor Unit)
- Select either of two cases to keep space for installation and services.

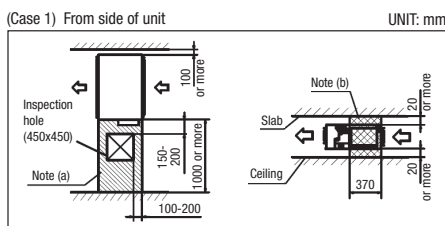

- Notes (a) There must not be obstacle to draw out fan motor. (▨ marked area)
 (b) Install refrigerant pipe, drain pipe, and wiring so as not to cross (▨ marked area).

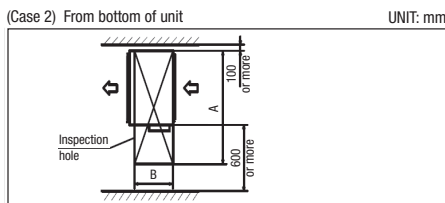

(Size of inspection hole)	UNIT: mm		
Single type	40-50	60, 71	100-140
Multi type	22-56	71, 90	112-160
A	1100	1300	1720
B	620	725	

③ Preparation before installation

- If suspension bolt becomes longer, do reinforcement of earthquake resistant.
 - For grid ceiling
 When the suspension bolt length is over 500mm, or the gap between the ceiling and roof is over 700mm, apply earthquake resistant brace to the bolt.
 - In case the unit is hanged directly from the slab and is installed on the ceiling plane which has enough strength.
 When suspension bolt length is over 1000mm, apply the earthquake resistant brace to the bolt.
- Prepare four (4) sets of suspension bolt, nut and spring washer (M10) on site.

Suspension Bolt Location

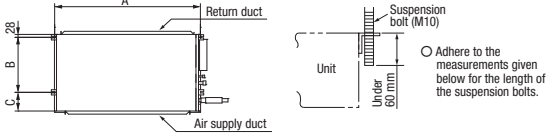

	UNIT: mm		
Multi type	22-56	71, 90	112-160
Single type	40-50	60, 71	100-140
A	786	986	1404
B	472	472	530
C	135	135	180

Pipe locations

	UNIT: mm
Multi type	22-90
Single type	40-71

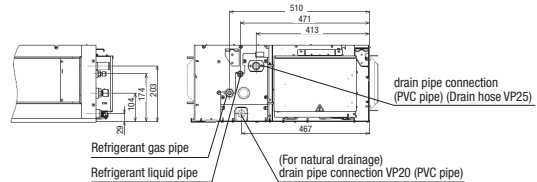

	UNIT: mm
Multi type	112-160
Single type	100-140

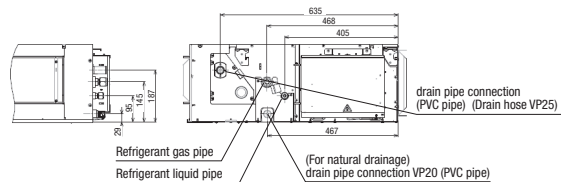

④ Installation of indoor unit

Installation

[Hanging]

Hang the unit up.

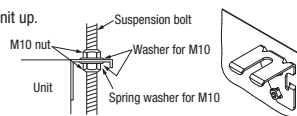

If the measurements between the unit and the ceiling hole do not match upon installation, it may be adjusted with the long holed installation tool.

Adjustment for horizontality

○ Either use a level vial, or adjust the level according to the method below.

- Adjust so the bottom side of the unit will be leveled with the water surface as illustrated below.

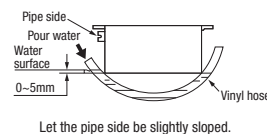

○ If the unit is not leveled, it may cause malfunctions or inoperation of the float switch.

⑤ Duct Work

① A corrugated board (for preventing sputtering) is attached to the main body of the air-conditioner (on the outlet port). Do not remove it until connecting the duct.

● An air filter can be provided on the main body of the air-conditioner (on the inlet port). Remove it when connecting the duct on the inlet port.

② Blowout duct

● Use rectangular duct to connect with unit.
Duct size for each unit is as shown below.

	UNIT: mm		
Single type	40-50	60, 71	100-140
Multi type	22-56	71, 90	112-140
A	692	882	1202
B	172	172	172

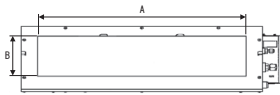

- Duct should be at their minimum length.
- We recommend to use sound and heat insulated duct to prevent it from condensation.
- Connect duct to unit before ceiling attachment.

③ Inlet port

- When shipped the inlet port lies on the back.
- When connecting the duct to the inlet port, remove the air filter if it is fitted to the inlet port.
- When placing the inlet port to carry out suction from the bottom side, use the following procedure to replace the suction duct joint and the bottom plate.

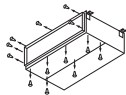

● Remove the screws which fasten the bottom plate and the duct joint on the inlet port side of the unit.

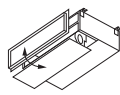

● Replace the removed bottom plate and duct joint.

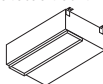

● Fit the duct joint with a screw; fit the bottom plate.

● Make sure to insulate the duct to prevent dewing on it.

④ Install the specific blowout duct in a location where the air will circulate to the entire room.

- Conduct the installation of the specific blowout hole and the connection of the duct before attaching them to the ceiling.
- Insulate the area where the duct is secured by a band for dew condensation prevention.

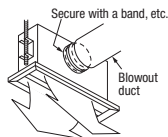

⑤ Make sure provide an inspection hole on the ceiling. It is indispensable to service electric equipment, motor, functional components and cleaning of heat exchanger.

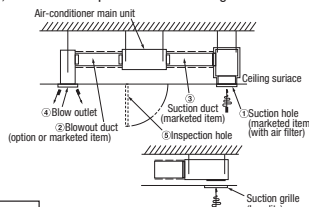

Bad example of duct work

① If a duct is not provided at the suction side but it is substituted with the space over the ceiling, humidity in the space will increase by the influence of capacity of ventilation fan, strength of wind blowing against the out door air louver, weather (rainy day) and others.

a) Moisture in air is likely to condense over the external plates of the unit and to drip on the ceiling. Unit should be operated under the conditions as listed in the above table and within the limitation of wind volume. When the building is a concrete structure, especially immediately after the construction, humidity tends to rise even if the space over the ceiling is not substituted in place of a duct. In such occasion, it is necessary to insulate the entire unit with glass wool (25mm). (Use a wire net or equivalent to hold the glass wool in place.)

b) It may run out the allowable limit of unit operation (Example: When outdoor air temperature is 35°C DB, suction air temperature is 27°C WB) and it could result in such troubles as compressor overload, etc..

c) There is a possibility that the blow air volume may exceed the allowable range of operation due to the capacity of ventilation fan or strength of wind blowing against external air louver so that drainage from be heat exchanger may fall to reach the drain pan but leak outside (Example: drip on to the ceiling) with consequential water leakage in the room.

② If vibration damping is not conducted between the unit and the duct, and between the unit and the slab, vibration will be transmitted to the duct and vibration noise may occur. Also, vibration may be transmitted from the unit to the slab. Vibration damping must be performed.

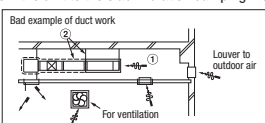

⑤ Duct Work (continued)

Connecting the air intake/vent ducts

① Fresh Air Intake

[for air intake duct only]

○ Use the side fresh air intake hole, or supply through a part of the suction duct.

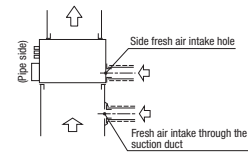

[for simultaneous air intake/vent]

○ Intake air through the suction duct.

(the side cannot be used)

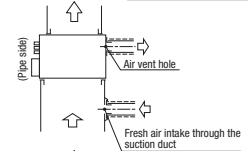

② Air Vent

○ Use the side air vent hole.

(always use together with the air intake)

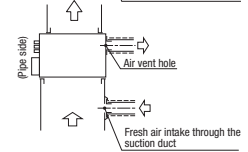

○ Insulate the duct to protect it from dew condensation.

⑥ Refrigerant pipe

Caution

● Be sure to use new pipes for the refrigerant pipes. Use the flare nut attached to the product.

Regarding whether existing pipes can be reused or not, and the washing method, refer to the instruction manual of the outdoor unit, catalogue or technical data.

- 1) In case of reuse: Do not use old flare nut, but use the one attached to the unit.
- 2) In case of reuse: Flare the end of pipe replaced partially for R32 or R410A.

⚠ WARNING : When flared joints are reused indoors, the flare part shall be re-fabricated. (only for R32)

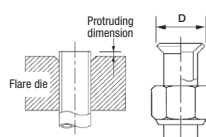

Pipe dia. d mm	Min. pipe wall thickness mm	Protruding dimension for flare, mm		Flare O.D. D mm	Flare nut tightening torque N·m
		Rigid (Clutch type) For R32 For R410A	Conventional tool		
6.35	0.8	0 - 0.5	0.7 - 1.3	8.9 - 9.1	14 - 18
9.52	0.8			12.8 - 13.2	34 - 42
12.7	0.8			16.2 - 16.6	49 - 61
15.88	1			19.3 - 19.7	68 - 82
19.05	1.2			23.6 - 24.0	100 - 120

● Use phosphorus deoxidized copper alloy seamless pipe (C1220T) for refrigeration pipe installation. In addition, make sure there is no damage both inside and outside of the pipe, and no harmful substances such as sulfur, oxide, dust or a contaminant stuck on the pipes.

● Do not use any refrigerant other than R32 or R410A.

Using other refrigerant except R32 or R410A (R22 etc.) may degrade inside refrigeration oil. And air getting into refrigeration circuit may cause over-pressure and resultant it may result in bursting, etc.

● Store the copper pipes indoors and seal the both end of them until they are brazed in order to avoid any dust, dirt or water getting into pipe. Otherwise it will cause degradation of refrigeration oil and compressor breakdown, etc.

● Use special tools for R32 or R410A refrigerant.

Piping work

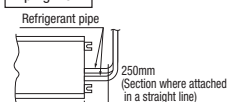

When conducting piping work, make sure to allow the pipes to be aligned in a straight line for at least 250 mm, as shown in the left illustration. (This is necessary for the drain pump to function)

Work procedure

1. Remove the flare nut and blind flanges on the pipe of the indoor unit.
※ Make sure to loosen the flare nut with holding the nut on pipe side with a spanner and giving torque to the nut with another spanner in order to avoid unexpected stress to the copper pipe, and then remove them. (Gas may come out at this time, but it is not abnormal.)

● Pay attention whether the flare nut pops out. (as the indoor unit is sometimes pressured.)

2. Make a flare on liquid pipe and gas pipe, and connect the refrigeration pipes on the indoor unit.
※ Bend radius of pipe must be 4D or larger. Once a pipe is bent, do not readjust the bending. Do not twist a pipe or collapse to 2/3D or smaller.

● Make sure to use flare nuts assembled on the unions.

Usage of other flare nuts could cause refrigerant leakage.

※ Do a flare connection as follows:

● Make sure to hold the nut on indoor unit pipe side using double spanner method as indicated when fastening / loosening flare nuts in order to prevent unintentional twisting of the copper pipe.

● When fastening the flare nut, align the refrigeration pipe with the center of flare nut, screw the nut for 3-4 times by hand and then tighten it by spanner with the specified torque mentioned in the table above.

3. Cover the flare connection part of the indoor unit with attached insulation material after a gas leakage inspection, and tighten both ends with attached straps.

● Make sure to insulate both gas pipes and liquid pipes completely.

※ Incomplete insulation may cause dew condensation or water dropping.

● Use heat-resistant (120 °C or more) insulations on the gas side pipes.

● In case of using at high humidity condition, reinforce insulation of refrigerant pipes. Surface of insulation may cause dew condition or water dropping, if insulations are not reinforced.

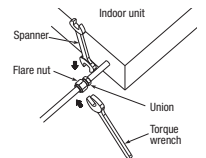

⑥ Refrigerant pipe (continued)

4. Refrigerant is charged in the outdoor unit. As for the additional refrigerant charge for the indoor unit and piping, refer to the installation manual attached to the outdoor unit.

Caution:
Refrigerating machine oil should not be applied to the threads of union or external surface of flare. It is because, even if the same tightening torque is applied, the oil is likely to decrease the slide friction force on the threads and increase, in turn, the axial component force so that it could crack the flare by the stress corrosion.
Refrigerating machine oil may be applied to the internal surface of flare only.

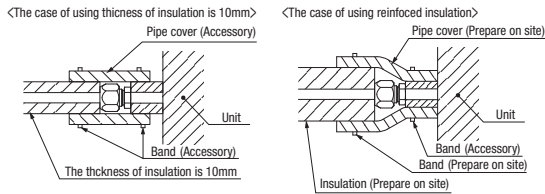

⑦ Drain pipe

Caution

- Install the drain pipe according to the installation manual in order to drain properly. Imperfection in draining may cause flood indoors and wetting the household goods, etc.
- Do not put the drain pipe directly into the ditch where toxic gas such as sulfur, the other harmful and inflammable gas is generated. Toxic gas would flow into the room and it would cause serious damage to user's health and safety (some poisoning or deficiency of oxygen). In addition, it may cause corrosion of heat exchanger and bad smell.
- Connect the pipe securely to avoid water leakage from the joint.
- Insulate the pipe properly to avoid condensation drop.
- Check if the water can flow out properly from both the drain outlet on the indoor unit and the end of the drain pipe after installation.
- Make sure to make descending slope of greater than 1/100 and do not make up-down bend and/or trap in the midway. In addition, do not put air vent on the drain pipe. Check if water is drained out properly from the pipe during commissioning. Also, keep sufficient space for inspection and maintenance.

Work procedure

1. Make sure to insert the drain hose (the end made of soft PVC) to the end of the step part of drain socket.

Attach the hose clamp to the drain hose around 10mm from the end, and fasten the screw about 5mm left to the nut.

- Do not apply adhesives on this end.
- Do not use acetone-based adhesives to connect to the drain socket.

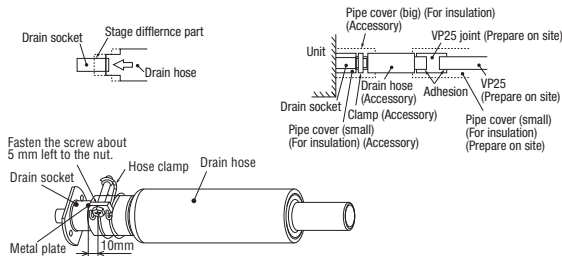

2. Prepare a joint for connecting VP25 pipe, adhere and connect the joint to the drain hose (the end made of rigid PVC), and adhere and connect VP25 pipe (prepare on site).

- ※As for drain pipe, apply VP25 made of rigid PVC which is on the market.
- Make sure that the adhesive will not get into the supplied drain hose. It may cause the flexible part broken after the adhesive is dried up and gets rigid.
- The flexible drain hose is intended to absorb a small difference at installation of the unit or drain pipes. Intentional bending, expanding may cause the flexible hose broken and water leakage.

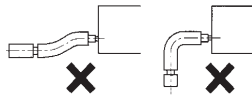

- As for drain pipe, apply VP25 (OD32). If apply PVC25 (OD25), connect the expanded connector to the drain hose, with adhesive. (Multi unit only)

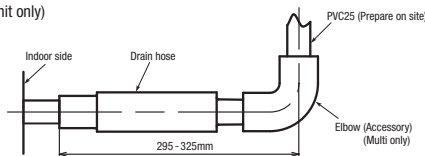

⑦ Drain pipe (continued)

3. Make sure to make descending slope of greater than 1/100 and do not make up-down bend and/or trap in the midway.

- Pay attention not to give stress on the pipe on the indoor unit side, and support and fix the pipe as close place to the unit as possible when connecting the drain pipe.
- Do not set up air vent.

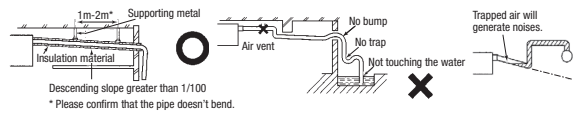

- When sharing a drain pipe for more than one unit, lay the main pipe 100mm below the drain outlet of the unit. In addition, select VP30 or bigger size for main drain pipe.

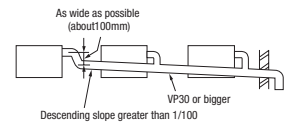

4. Insulate the drain pipe.

- Be sure to insulate the drain socket and rigid PVC pipe installed indoors otherwise it may cause dew condensation and water leakage.
- ※After drainage test implementation, cover the drain socket part with pipe cover (small size), then use the pipe cover (big size) to cover the pipe cover (small size), clamps and part of the drain hose, and fix and wrap it with tapes to wrap and make joint part gapless.

Drain up

- The position for drain pipe outlet can be raised up to 600mm above the ceiling. Use elbows for installation to avoid obstacles inside ceiling. If the horizontal drain pipe is too long before vertical pipe, the backflow of water will increase when the unit is stopped, and it may cause overflow of water from the drain pan on the indoor unit. In order to avoid overflow, keep the horizontal pipe length and offset of the pipe within the limit shown in the figure below.

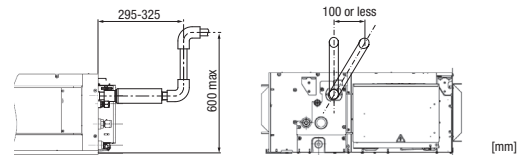

Otherwise, the construction point makes it same as drain pipe construction.

Drain test

1. Conduct a drain test after completion of the electrical work.
2. During the trial, make sure that drain flows properly through the piping and that no water leaks from connections.
3. In case of a new building, conduct the test before it is furnished with the ceiling.
4. Be sure to conduct this test even when the unit is installed in the heating season.

Procedures

1. Supply about 1000 cc of water to the unit through the air outlet by using a feed water pump.
2. Check the drain while cooling operation.

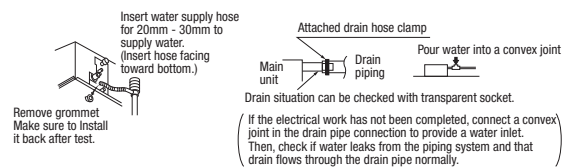

Outline of bottom drain piping work

- If the bottom drain piping can be done with a descending gradient (1/50-1/100), it is possible to connect the pipes as shown in the drawing below.

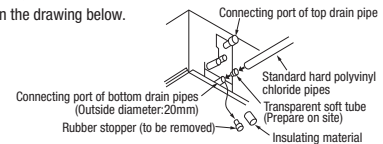

Uncoupling the drain motor connector

- Uncouple the connector CnR for the drain motor as illustrated in the drawing on the right.

(Note: If the unit is run with the connector coupled,) drain water will be discharged from the upper drain pipe joint, causing a water leak.

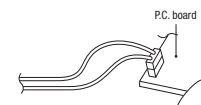

⑧ Wiring-out position and wiring connection

- Electrical installation work must be performed according to the installation manual by an electrical installation service provider qualified by a power provider of the country, and be executed according to the technical standards and other regulations applicable to electrical installation in the country.
Be sure to use an exclusive circuit.
 - Use specified cord, fasten the wiring to the terminal securely, and hold the cord securely in order not to apply unexpected stress on the terminal.
 - Do not put both power source line and signal line on the same route. It may cause miscommunication and malfunction.
 - Be sure to do D type earth work.
 - For the details of electrical wiring work, see attached instruction manual for electrical wiring work.
1. Remove a lid of the control box (2 screws).
 2. Hold each wiring inside the unit and fasten them to terminal block securely.
 3. Fix the wiring with clamps.
 4. Install the removed parts back to original place.

Single unit wiring connection

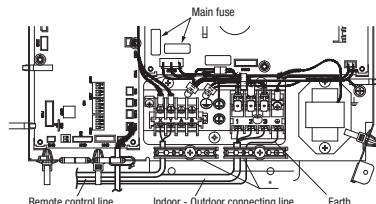

Multi unit wiring connection

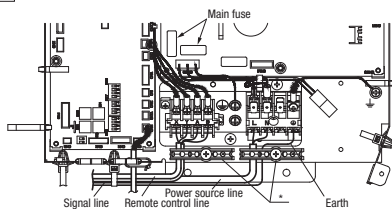

* Please fix the wiring in the band not to move even if it pulls.

Main fuse specification

Model	Specification	Part No.
22-56	T3.15A L250V	SSA564A149AF
71-160	T5A L250V	SSA564A149AH

⑨ External static pressure setting

You can set External Static Pressure (E.S.P.) by either method of MANUAL SETTING or AUTOMATIC SETTING by remote control.
Indoor unit will control fan-speed to keep rated air flow volume at each fan speed setting (Lo-Uhi)

1. MANUAL SETTING

You can set required E.S.P. by wired remote control that calculated with the set air flow rate and pressure loss of the duct connected.

Select No.1-10 (10Pa-100Pa) from following table according to calculation result.

Refer to technical manual for details of air flow characteristic.

Setting No.	1	2	3	4	5	6	7	8	9	10
External Static Pressure (Pa)	10	20	30	40	50	60	70	80	90	100

※ When you set No.11-19 by remote control, unit will control fan-speed with setting of No.10 Factory default is at No.5.

● How to set E.S.P. by wired remote control

- ① Push "◆" marked button(E.S.P. button).
 - ② Select indoor unit No. by using ◆ button.
 - ③ Select setting No. by using ◆ button and set E.S.P. by □ button.
- See detailed procedure in technical manual.

Notice

You can not set E.S.P. by wireless remote control.

E.S.P. button



Caution

Be sure to set E.S.P. according to actual duct connected.

Wrong settings causes excessive air flow volume or water drop blown out.

2. AUTOMATIC SETTING

Indoor unit will recognize E.S.P. by itself automatically and select appropriate fan speed No.1-10.

⑨ External static pressure setting (continued)

● How to start automatic setting

- ①, ② Same setting as MANUAL SETTING.
- ③ Select [AUT] by using ◆ button and press □ button.
- ④ After setting E.S.P. at "AUT", operate unit in FAN mode with certain fan speed (Lo-Uhi).

Indoor unit fan will run automatically and recognize E.S.P. by itself.

The operation for automatic E.S.P. recognition will last about 6 minutes, and it will be stopped after recognition is completed.

Caution

- Be sure to execute AUTOMATIC SETTING by remote control AFTER ducting work is completed.
- When duct specification is changed after AUTOMATIC SETTING, be sure to execute AUTOMATIC SETTING again after power resetting and turning on again.
- Be sure to execute AUTOMATIC SETTING before trial cooling operation.
- (See ELECTRICAL WIRING WORK INSTRUCTION about trial cooling operation)
- Before AUTOMATIC SETTING, be sure to check that return air filter in duct is installed and damper is opened.
- Wrong procedure causes excessive air flow or water drop blown out.

Notice

- During operation for automatic recognition (the Auto Operation), fan rotates with certain speeds regardless of set fan speed by remote control.
- When duct is set with low static pressure (around 10-50Pa), even if indoor unit operate with higher air flow volume than rated one, but it is not abnormal.
- When you changed operation mode or stop operation with ON/OFF button during Auto Operation, the Auto operation will be canceled.
- In such case, be sure to execute AUTOMATIC SETTING again according to above procedure.

⑩ Check list after installation

● Check the following items after all installation work completed.

Check if	Expected trouble	Check
The indoor and outdoor units are fixed securely?	Falling, vibration, noise	
Inspection for leakage is done?	Insufficient capacity	
Insulation work is properly done?	Water leakage	
Water is drained properly?	Water leakage	
Power source voltage is same as mentioned in the model name plate?	PCB burnt out, not working at all	
No mis-wiring or mis-connection of piping?	PCB burnt out, not working at all	
Earth wiring is connected properly?	Electric shock	
Cable size comply with specified size?	PCB burnt out, not working at all	
Any obstacle blocks air flow on air inlet and outlet?	Insufficient capacity	
Is setting of E.S.P. finished?	Excessive air flow, water drop blown out	

(b) Replacement procedure of the fan unit

- Notes(1) The unit is a heavy item. It must be supported securely and handled with care not to drop when it is necessary to replace.
(2) For the maintenance space, refer to page 77.

(i) Model FDUM40VH

- 1) Remove the control box and the side panel, and remove screws marked in the circles (2 places) in the figure.

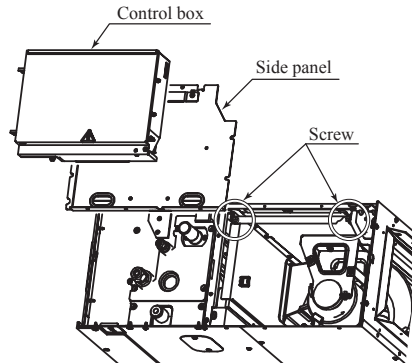

- 2) Take out the fan unit in the arrow direction.

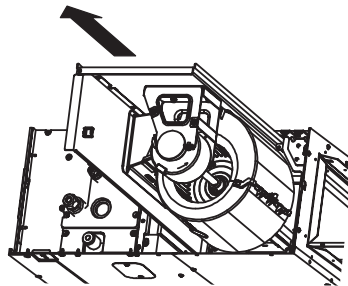

(ii) Model FDUM71VH

- 1) Remove the control box and the side panel, and remove screws marked in the circles (2 places) in the figure.

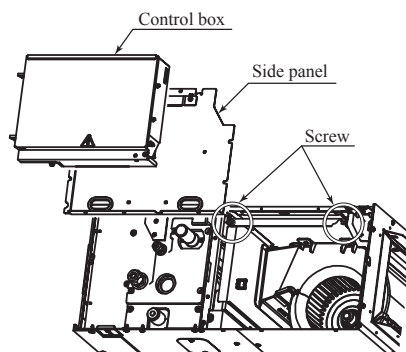

- 2) Take out the fan unit in the arrow direction.

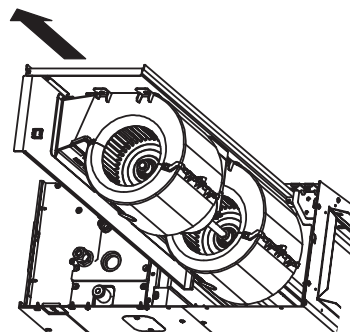

PFA012D636A

(5) Ceiling suspended type (FDE)

This manual is for the installation of an indoor unit. For electrical wiring work (Indoor), refer to page 91. For remote control installation, refer to page 95. For wireless kit installation, refer to page 165. For electrical wiring work (Outdoor) and refrigerant pipe work installation for outdoor unit, refer to page 107.

SAFETY PRECAUTIONS

- Read the "SAFETY PRECAUTIONS" carefully first of all and then strictly follow it during the installation work in order to protect yourself.
- The precautionary items mentioned below are distinguished into two levels. **⚠️ WARNING** and **⚠️ CAUTION**.
⚠️ WARNING: Wrong installation would cause serious consequences such as injuries or death.
⚠️ CAUTION: Wrong installation might cause serious consequences depending on circumstances.
 Both mentions the important items to protect your health and safety so strictly follow them by any means.
- The meanings of "Marks" used here are as shown as follows:
 ⓧ Never do it under any circumstances. ⓧ Always do it according to the instruction.
- After completing the installation, do commissioning to confirm there are no abnormalities, and explain to the customers about "SAFETY PRECAUTIONS", correct operation method and maintenance method (air filter cleaning, operation method and temperature setting method) with user's manual of this unit. Ask your customers to keep this installation manual together with the user's manual. Also, ask them to hand over the user's manual to the new user when the owner is changed.

⚠️ WARNING

- **Installation should be performed by the specialist.** ⓧ
If you install the unit by yourself, it may lead to serious trouble such as water leakage, electric shock, fire, and injury due to overturn of the unit.
- **Install the system correctly according to these installation manuals.** ⓧ
Improper installation may cause explosion, injury, water leakage, electric shock, and fire.
- **When installing in small rooms, take prevention measures not to exceed the density limit of refrigerant in the event of leakage, referred by the formula (accordance with ISO5149).** ⓧ
If the density of refrigerant exceeds the limit, please consult the dealer and install the ventilation system, otherwise lack of oxygen can occur, which can cause serious accidents.
- **Use the genuine accessories and the specified parts for installation.** ⓧ
If parts unspecified by our company are used it could cause water leakage, electric shock, fire, and injury due to overturn of the unit.
- **Ventilate the working area well in case the refrigerant leaks during installation.** ⓧ
If the refrigerant contacts the fire, toxic gas is produced.
In case of R32, the refrigerant could be ignited because of its flammability.
- **Install the unit in a location that can hold heavy weight.** ⓧ
Improper installation may cause the unit to fall leading to accidents.
- **Install the unit properly in order to be able to withstand strong winds such as typhoons, and earthquakes.** ⓧ
Improper installation may cause the unit to fall leading to accidents.
- **Do not mix air in to the cooling cycle on installation or removal of the air-conditioner.** ⓧ
If air is mixed in, the pressure in the cooling cycle will rise abnormally and may cause explosion and injuries.
- **Be sure to have the electrical wiring work done by qualified electrical installer, and use exclusive circuit.** ⓧ
Power source with insufficient capacity and improper work can cause electric shock and fire.
- **Use specified wire for electrical wiring, fasten the wiring to the terminal securely, and hold the cable securely in order not to apply unexpected stress on the terminal.** ⓧ
Loose connections or hold could result in abnormal heat generation or fire.
- **Arrange the electrical wires in the control box properly to prevent them from rising. Fit the lid of the services panel properly.** ⓧ
Improper fitting may cause abnormal heat and fire.
- **Check for refrigerant gas leakage after installation is completed.** ⓧ
If the refrigerant gas leaks into the house and comes in contact with a fan heater, a stove, or an oven, toxic gas is produced.
- **Use the specified pipe, flare nut, and tools for R32 or R410A.** ⓧ
Using existing parts (R22) could cause the unit failure and serious accident due to explosion of the cooling cycle.
- **Tighten the flare nut according to the specified method by with torque wrench.** ⓧ
If the flare nut were tightened with excess torque, it could cause burst and refrigerant leakage after a long period.
- **Do not put the drainage pipe directly into drainage channels where poisonous gases such as sulfide gas can occur.** ⓧ
Poisonous gases will flow into the room through drainage pipe and seriously affect the user's health and safety. This can also cause the corrosion of the indoor unit and a resultant unit failure or refrigerant leak.
- **Connect the pipes for refrigeration circuit securely in installation work before compressor is operated.** ⓧ
If the compressor is operated when the service valve is open without connecting the pipe, it could cause explosion and injuries due to abnormal high pressure in the system.
- **Stop the compressor before removing the pipe after shutting the service valve on pump down work.** ⓧ
If the pipe is removed when the compressor is in operation with the service valve open, air would be mixed in the refrigeration circuit and it could cause explosion and injuries due to abnormal high pressure in the cooling cycle.
- **Only use prescribed option parts. The installation must be carried out by the qualified installer.** ⓧ
If you install the system by yourself, it can cause serious trouble such as water leaks, electric shocks, fire.
- **Do not repair by yourself. And consult with the dealer about repair.** ⓧ
Improper repair may cause water leakage, electric shock or fire.
- **Consult the dealer or a specialist about removal of the air-conditioner.** ⓧ
Improper installation may cause water leakage, electric shock or fire.
- **Turn off the power source during servicing or inspection work.** ⓧ
If the power is supplied during servicing or inspection work, it could cause electric shock and injury by the operating fan.
- **Do not run the unit when the panel or protection guard are taken off.** ⓧ
Touching the rotating equipment, hot surface, or high voltage section could cause an injury to be caught in the machine, to get burned, or electric shock.
- **Shut off the power before electrical wiring work.** ⓧ
It could cause electric shock, unit failure and improper turning.

⚠️ CAUTION

- **Perform earth wiring surely.** ⓧ
Do not connect the earth wiring to the gas pipe, water pipe, lightning rod and telephone earth wiring. Improper earth could cause unit failure, electric shock and fire due to a short circuit.
- **Earth leakage breaker must be installed.** ⓧ
If the earth leakage breaker is not installed, it can cause fire and electric shocks.
- **Use the circuit breaker of correct capacity. Circuit breaker should be the one that disconnect all poles under over current.** ⓧ
Using the incorrect one could cause the system failure and fire.
- **Do not use any materials other than a fuse of correct capacity where a fuse should be used.** ⓧ
Connecting the circuit by wire or copper wire could cause unit failure and fire.
- **Do not install the indoor unit near the location where there is possibility of flammable gas leakages.** ⓧ
If the gas leaks and gathers around the unit, it could cause fire.
- **Do not install and use the unit where corrosive gas (such as sulfurous acid gas etc.) or flammable gas (such as thinner, petroleum etc.) may be generated or accumulated, or volatile flammable substances are handled.** ⓧ
It could cause the corrosion of heat exchanger, breakage of plastic parts etc. And inflammable gas could cause fire.
- **Secure a space for installation, inspection and maintenance specified in the manual.** ⓧ
Insufficient space can result in accident such as personal injury due to falling from the installation place.
- **Do not use the indoor unit at the place where water splashes such as laundry.** ⓧ
Indoor unit is not waterproof. It could cause electric shock and fire.
- **Do not use the indoor unit for a special purpose such as food storage, cooling for precision instrument, preservation of animals, plants, and a work of art.** ⓧ
It could cause the damage of the items.
- **Do not install nor use the system near equipments which generate electromagnetic wave or high harmonics.** ⓧ
Equipments like inverter equipment, private power generator, high-frequency medical equipment, or telecommunication equipment might influence the air-conditioner and cause a malfunction and breakdown. Or the air-conditioner might influence medical equipments or telecommunication equipments, and obstruct their medical activity or cause jamming.
- **Do not install the remote control at the direct sunlight.** ⓧ
It could cause breakdown or deformation of the remote control.
- **Do not install the indoor unit at the place listed below.** ⓧ
 - Places where flammable gas could leak.
 - Places where carbon fiber, metal powder or any powder is floated.
 - Places where the substances which affect the air-conditioner are generated such as sulfide gas, chlorine gas, acid, alkali or ammoniac atmospheres.
 - Places exposed to oil mist or steam directly.
 - On vehicles and ships
 - Places where machinery which generates high harmonics is used.
 - Places where cosmetics or special sprays are frequently used.
 - Highly salted area such as beach.
 - Heavy snow area
 - Places where the system is affected by smoke from a chimney.
 - Altitude over 1000m
- **Do not install the indoor unit in the locations listed below (Be sure to install the indoor unit according to the installation manual for each model because each indoor unit has each limitation)** ⓧ
 - Locations with any obstacles which can prevent inlet and outlet air of the unit.
 - Locations where vibration can be amplified due to insufficient strength of structure.
 - Locations where the infrared receiver is exposed to the direct sunlight or the strong light beam. (in case of the infrared specification unit)
 - Locations where an equipment affected by high harmonics is placed. (TV set or radio receiver is placed within 5m)
 - Locations where drainage cannot run off safely. It can affect performance or function and etc..
 - Do not install the motion sensor at following places. It could cause detection error, incapacity of detection, or characteristic degradation.
 - Place where vibration is applied to it for a long period of time.
 - Place where static electricity or electromagnetic wave generates.
 - Place where it is exposed to high temperature or humidity for a long period of time.
 - Dusty place or where the lens face could be fouled or damaged.
- **Do not put any valuables which will break down by getting wet under the air-conditioner.** ⓧ
Condensation could drop when the relative humidity is higher than 80% or drain pipe is clogged, and it damages user's belongings.
- **Do not use the base frame for the outdoor unit which is corroded or damaged after a long period of use.** ⓧ
It could cause the unit falling down and injury.
- **Pay attention not to damage the drain pan by weld sputter when brazing work is done near the unit.** ⓧ
If sputter entered into the unit during brazing work, it could cause damage (pinhole) of drain pan and leakage of water. To avoid damaging, keep the indoor unit packed or cover the indoor unit.
- **Install the drain pipe to drain the water surely according to the installation manual.** ⓧ
Improper connection of the drain pipe may cause dropping water into room and damaging user's belongings.
- **Do not share the drain pipe for indoor unit and GHP (Gas Heat Pump system) outdoor unit.** ⓧ
Toxic exhaust gas would flow into room and it might cause serious damage (some poisoning or deficiency of oxygen) to user's health and safety.
- **Be sure to perform air tightness test by pressurizing with nitrogen gas after completed refrigerant piping work.** ⓧ
If the density of refrigerant exceeds the limit in the event of refrigerant leakage in the small room, lack of oxygen can occur, which can cause serious accidents.
- **For drain pipe installation, be sure to make descending slope of greater than 1/100, not to make traps, and not to make air-bleeding.** ⓧ
Check if the drainage is correctly done during commissioning and ensure the space for inspection and maintenance.
- **Ensure the insulation on the pipes for refrigeration circuit so as not to condense water.** ⓧ
Incomplete insulation could cause condensation and it would wet ceiling, floor, and any other valuables.
- **Do not install the outdoor unit where is likely to be a nest for insects and small animals.** ⓧ
Insects and small animals could come into the electronic components and cause breakdown and fire. Instruct the user to keep the surroundings clean.
- **Pay extra attention, carrying the unit by hand.** ⓧ
Carry the unit with 2 people if it is heavier than 20kg. Do not use the plastic straps but the grabbing place, moving the unit by hand. Use protective gloves in order to avoid injury by the aluminum fin.
- **Make sure to dispose of the packaging material.** ⓧ
Leaving the materials may cause injury as metals like nail and woods are used in the package.
- **Do not operate the system without the air filter.** ⓧ
It may cause the breakdown of the system due to clogging of the heat exchanger.
- **Do not touch any button with wet hands.** ⓧ
It could cause electric shock.
- **Do not touch the refrigerant piping with bare hands when in operation.** ⓧ
The pipe during operation would become very hot or cold according to the operating condition, and it could cause a burn or frostbite.
- **Do not clean up the air-conditioner with water.** ⓧ
It could cause electric shock.
- **Do not turn off the power source immediately after stopping the operation.** ⓧ
Be sure to wait for more than 5 minutes. Otherwise it could cause water leakage or breakdown.
- **Do not control the operation with the circuit breaker.** ⓧ
It could cause fire or water leakage. In addition, the fan may start operation unexpectedly and it may cause injury.

1 Before installation

- Install correctly according to the installation manual.
- Confirm the following points:
 - Unit type/Power source specification
 - Pipes/Wires/Small parts
 - Accessory items

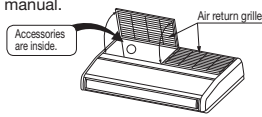

Accessory item

For unit hanging		For refrigerant pipe			For drain pipe				For air return grille	
Flat washer (M10)	Paper pattern	Pipe cover (large)	Pipe cover (small)	Strap	Drain hose (with clamp)	Hose clamp	Fixing bracket	Screw	Heavy insulation	Screw
8	1	1	1	4	1	1	1	2	1	4
For unit hanging	For unit hanging and adjustment	For heat insulation of gas pipe	For heat insulation of liquid pipe	For fixing of pipe cover	For drain pipe connection	For drain hose mounting	For fixing of drain hose	For installing of fixing bracket	For drain hose	For fixing air return grille

2 Selection of installation location for the indoor unit

- Select the suitable areas to install the unit under approval of the user.
 - Areas where the indoor unit can deliver hot and cold wind sufficiently. Suggest to the user to use a circulator if the ceiling height is over 3m to avoid warm air being accumulated on the ceiling.
 - In case of having the motion sensor, the installation height must be no higher than 4 m. It could reduce the sensitivity of motion sensor, disabling the detection.
 - Areas where there is enough space to install and service.
 - Areas where it can be drained properly. Areas where drain pipe descending slope can be taken.
 - Areas where there is no obstruction of air flow on both air return grille and air supply port.
 - Areas where fire alarm will not be accidentally activated by the air-conditioner.
 - Areas where the supply air does not short-circuit.
 - Areas where it is not influenced by draft air.
 - Areas not exposed to direct sunlight.
 - Areas where dew point is lower than around 28°C and relative humidity is lower than 80%.

This indoor unit is tested under the condition of JIS (Japan Industrial Standard) high humidity condition and confirmed there is no problem. However, there is some risk of condensation drop if the air-conditioner is operated under the severer condition than mentioned above.

If there is a possibility to use it under such a condition, attach additional insulation of 10 to 20mm thick for entire surface of indoor unit, refrigeration pipe and drain pipe.

 - Areas where TV and radio stays away more than 1m. (It could cause jamming and noise.)
 - Areas where any items which will be damaged by getting wet are not placed such as food, table wares, server, or medical equipment under the unit.
 - Areas where there is no influence by the heat which cookware generates.
 - Areas where not exposed to oil mist, powder and/or steam directly such as above fryer.
 - Areas where lighting device such as fluorescent light or incandescent light doesn't affect the operation. (A beam from lighting device sometimes affects the infrared receiver for the wireless remote control and the air conditioner might not work properly.)
- Check if the place where the air-conditioner is installed can hold the weight of the unit. If it is not able to hold, reinforce the structure with boards and beams strong enough to hold it. If the strength is not enough, it could cause injury due to unit falling.
- If there are 2 units of wireless type, keep them away for more than 6m to avoid malfunction due to cross communication.
- When plural indoor units are installed nearby, it is recommended to separate each other more than 4m.

Space for installation and service

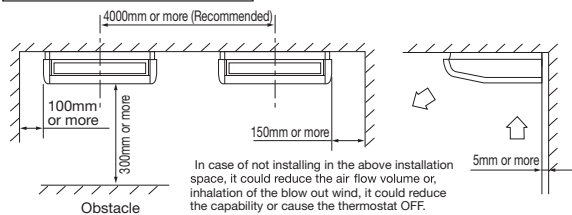

3 Preparation before installation

- If suspension bolt becomes longer, do reinforcement of earthquake resistant.
 - For grid ceiling
 - When suspension bolt length is over 500mm, or the gap between the ceiling and roof is over 700mm, apply earthquake resistant brace to the bolt.
 - In case the unit is hanged directly from the slab and is installed on the ceiling plane which has enough strength.
 - When suspension bolt length is over 1000mm, apply the earthquake resistant brace to the bolt.
- Prepare four (4) sets of suspension bolt, nut and spring washer (M10) on site.

Pitch of suspension bolts and pipe position

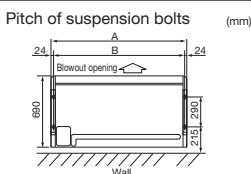

Location of pipe outlets

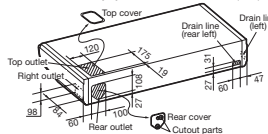

3 Preparation before installation (continued)

Series	type	(mm)	
		A	B
Single split (PAC) series	40 to 50type	1070	1022
	60 to 71type	1320	1272
	100 to 140type	1620	1572
VRF (KX) series	36 to 56type	1070	1022
	71type	1320	1272
	112 to 140type	1620	1572

※Pipes can be taken out in 3 directions (rear, right or top).

- Cut out holes using nippers, etc.
- Cut out holes to take out pipes along the cutoff line on the rear cover.
- Cut out the top face cover aligning to the piping position.
- When taking pipe out to right-hand side, cut out a hole along the groove at the inside of side panel.
- After installing pipes and wires, seal clearances around pipes and wires with putty, etc. to shut off dust.

Pipe position (mm)

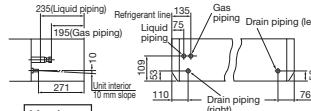

Make sure to install the covers at rear and top in order to protect the inside of unit from intrusion of dust or protect wires from damages by sharp edges. When taking them out to the right-hand side, remove burrs or sharp edges from the cutout.

Haulage

- Move the box as close to the installation area as possible packed.
- If it must be unpacked, wrap the unit with a nylon sling, and be careful not to damage the unit.
 - ※Do not hold fragile plastic parts, such as the side panel, blow louver, etc.
- If you need to lay the unit on a floor after unpacking, always put it with the intake grille facing upward.



Preparation before installation

1. Remove the air return grille.

Slide stoppers (4 places) of the catches, then pull out the pins (4 or 6 places).

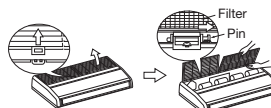

3. Remove the hanging plate.

Remove the screw, and then loosen the fixing bolts.

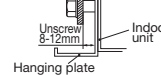

2. Remove the side panel.

Remove the screw and detach the side panel by sliding it toward the direction indicated by the arrow mark.

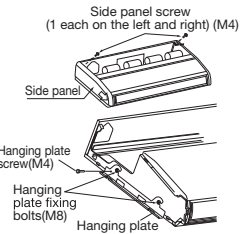

4 Installation of indoor unit

WARNING

Completely seal the hole in the wall with putty. If not sealed properly, dust, insects, small animals, and highly humid air may enter the room from outside, which could result in fire or other hazards.

CAUTION

Completely seal the hole in the wall with putty. If not sealed properly, furniture and other fixtures may be damaged by water leakage or condensation.

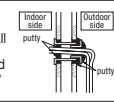

Work procedure

- Select the suspension bolt locations and the pipe hole location.
 - (1) Use enclosed paper pattern as a reference, and drill the holes for the suspension bolts and pipe.
 - ※Decide the locations based on direct measurements.
 - (2) Once the locations are properly placed, the paper pattern can be removed.
- Install the suspension bolts in place.
- Fix with 4 suspension bolts, which can endure load of 500N.
- Check the measurements given at the right figure for the length of the suspension bolts.
- Fasten the hanging plate onto the suspension bolts.

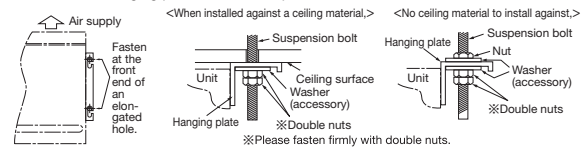

6. Install the unit to the hanging plate. (See the figure at right.)

- (1) Slide the unit in from front side to get it hanged on the hanging plate with the bolts.
- (2) Fasten the four fixing bolts (M8: 2 each on the left and right sides) firmly.
- (3) Fasten the two screws (M4: 1 each on the left and right sides).

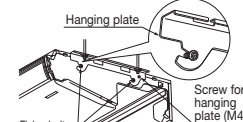

WARNING : Hang a side panel on from the panel side to the rear side and then fasten it securely onto the indoor unit with screws.

※To ensure smooth drain flow, install the unit with a descending slope toward the drain outlet.

CAUTION : Do not give the reversed slope, which may cause water leaks.

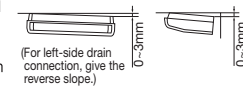

5 Refrigerant pipe

Caution

- Be sure to use new pipes for the refrigerant pipes. Use the flare nut attached to the product. Regarding whether existing pipes can be reused or not, and the washing method, refer to the instruction manual of the outdoor unit, catalogue or technical data.
- 1) In case of reuse: Do not use old flare nut, but use the one attached to the unit.
- 2) In case of reuse: Flare the end of pipe replaced partially for R32 or R410A.

⚠ **WARNING** : When flared joints are reused indoors, the flare part shall be re-fabricated. (only for R32)

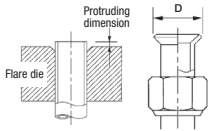

Pipe dia. d mm	Min. pipe wall thickness mm	Protruding dimension for flare, mm		Flare O.D. D mm	Flare nut tightening torque N·m
		Rigid (Clutch type) For R32 For R410A	Conventional tool		
6.35	0.8	0 - 0.5	0.7 - 1.3	8.9 - 9.1	14 - 18
9.52	0.8			12.5 - 13.2	34 - 42
12.7	0.8			16.2 - 16.6	49 - 61
15.88	1			19.3 - 19.7	68 - 82
19.05	1.2			23.6 - 24.0	100 - 120

- Use phosphorus deoxidized copper alloy seamless pipe (C1220T) for refrigeration pipe installation. In addition, make sure there is no damage both inside and outside of the pipe, and no harmful substances such as sulfur, oxide, dust or a contaminant stuck on the pipes.
- Do not use any refrigerant other than R32 or R410A.
- Using other refrigerant except R32 or R410A (R22 etc.) may degrade inside refrigeration oil. And air getting into refrigeration circuit may cause over-pressure and resultant it may result in bursting, etc.
- Store the copper pipes indoors and seal the both end of them until they are brazed in order to avoid any dust, dirt or water getting into pipe. Otherwise it will cause degradation of refrigeration oil and compressor breakdown, etc.
- Use special tools for R32 or R410A refrigerant.

Work procedure

- Remove the flare nut and blind flanges on the pipe of the indoor unit.
 - ※ Make sure to loosen the flare nut with holding the nut on pipe side with a spanner and giving torque to the nut with another spanner in order to avoid unexpected stress to the copper pipe, and then remove them. (Gas may come out at this time, but it is not abnormal.)
 - Pay attention whether the flare nut pops out. (as the indoor unit is sometimes pressurized.)
- Make a flare on liquid pipe and gas pipe, and connect the refrigeration pipes on the indoor unit.
 - When pulling out pipes backward or upward, install them passing through the attached cover together with the electrical cabling.
 - Seal the gap with putty, or other, to protect from dust, etc.
 - ※ Bend radius of pipe must be 4D or larger. Once a pipe is bent, do not readjust the bending. Do not twist a pipe or collapse to 2/3D or smaller.
 - Make sure to use flare nuts assembled on the unions. Usage of other flare nuts could cause refrigerant leakage.
 - ※ Do a flare connection as follows:
 - Make sure to hold the nut on indoor unit pipe side using double spanner method as indicated when fastening / loosening flare nuts in order to prevent unintentional twisting of the copper pipe.
 - When fastening the flare nut, align the refrigeration pipe with the center of flare nut, screw the nut for 3-4 times by hand and then tighten it by spanner with the specified torque mentioned in the table above.
- Cover the flare connection part of the indoor unit with attached insulation material after a gas leakage inspection, and tighten both ends with attached straps.
 - Make sure to insulate both gas pipes and liquid pipes completely.
 - ※ Incomplete insulation may cause dew condensation or water drooping.
 - Use heat-resistant (120 °C or more) insulations on the gas side pipes.
 - In case of using at high humidity condition, reinforce insulation of refrigerant pipes. Surface of insulation may cause dew condensation or water drooping, if insulations are not reinforced.
- Refrigerant is charged in the outdoor unit. As for the additional refrigerant charge for the indoor unit and piping, refer to the installation manual attached to the outdoor unit.

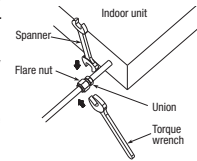

Caution: Refrigerating machine oil should not be applied to the threads of union or external surface of flare. It is because, even if the same tightening torque is applied, the oil is likely to decrease the side friction force on the threads and increase, in turn, the axial component force so that it could crack the flare by the stress corrosion. Refrigerating machine oil may be applied to the internal surface of flare only.

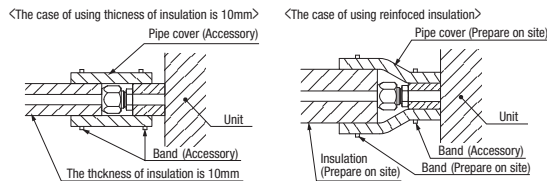

The pipe can be connected from three different directions. (back, right, top)

- When the pipe is routed through the back. If the bracket is removed, piping work will become easy. ※After piping, reinstall the removed bracket.

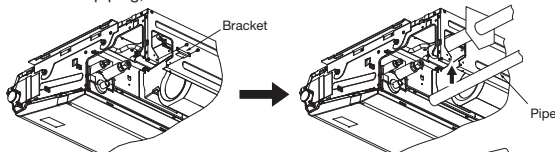

- When the pipe is routed through the top. Cut the removed top cover, and install to the rear panel instead of rear cover.

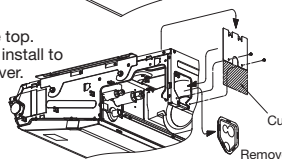

6 Drain pipe

- The drain pipes may pull out either from back, right or left side.

Caution

- Install the drain pipe according to the installation manual in order to drain properly. Imperfection in draining may cause flood indoors and wetting the household goods, etc.
- Do not put the drain pipe directly into the ditch where toxic gas such as sulfur, the other harmful and inflammable gas is generated. Toxic gas would flow into the room and it would cause serious damage to user's health and safety (some poisoning or deficiency of oxygen). In addition, it may cause corrosion of heat exchanger and bad smell.
- Connect the pipe securely to avoid water leakage from the joint.
- Insulate the pipe properly to avoid condensation drop.
- Check if the water can flow out properly from both the drain outlet on the indoor unit and the end of the drain pipe after installation.
- Make sure to make descending slope of greater than 1/100 and do not make up-down bend and/or trap in the midway. In addition, do not put air vent on the drain pipe. Check if water is drained out properly from the pipe during commissioning. Also, keep sufficient space for inspection and maintenance.

Work procedure

- Insert drain hose completely to the base, and tighten the drain hose clamp securely. (adhesive must not be used.)
 - ※ When plumbing on the left side, move the rubber plug and the cylindrical insulating materials by the pipe connecting hole on the left side of the unit to the right side.
- Beware of a possible outflow of water that may occur upon removal of a drain plug.
 - Take head of electrical cables so that they may not run beneath the drain hose.
- Fix the drain hose at the lowest point with a hose clamp supplied as an accessory.
 - ※ Give a drain hose a gradient of 10mm as illustrated in the right drawing by laying it without leaving a slack.
- Connect VP20(prepare on site) to drain hose. (Adhesive must not be used.)
 - ※ Use commercially available rigid PVC general pipe VP20 for drain pipe.
- Do not to make the up-down bending and trap in the mid-way while assuming that the drain pipes is downhill. (more than 1/100)
 - Never set up air vent.
- Insulate the drain pipe.
 - Insulate the drain hose clamp with the heat insulation supplied as accessories.
 - When the unit is installed in a humid place, consider precautions against dew condensation such as heat insulation for the drain pipe.

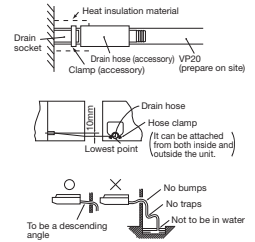

Drain test

- After installation of drain pipe, make sure that drain system work in good condition and no water leakage from joint and drain pan.
- Do drain test even if installation of heating season.

7 Wiring-out position and wiring connection

- Electrical installation work must be performed according to the installation manual by an electrical installation service provider qualified by a power provider of the country, and be executed according to the technical standards and other regulations applicable to electrical installation in the country. Be sure to use an exclusive circuit.
 - Use specified cord, fasten the wiring to the terminal securely, and hold the cord securely in order not to apply unexpected stress on the terminal.
 - Do not put both power source line and signal line on the same route. It may cause miscommunication and malfunction.
 - Be sure to do D type earth work.
 - For the details of electrical wiring work, see attached instruction manual for electrical wiring work.
- Remove wiring from clips.
 - Remove the control box (Screw ①, 2pcs).
 - Pull out the control box by sliding along the groove on the bracket (Direction A→B).
 - Remove the lid of control box (Screw ②, 2pcs).
 - Hold each wiring inside the unit and connect to the terminal block surely.
 - Fix the wiring by clamp.
 - Install the lid of control box (Screw ②, 2pcs).
 - Return the control box to the original place by sliding along the groove on the bracket (Direction B→A).
 - Install the removed parts at their original places.
- ※ 1 Wiring for the signal receiving section of wireless kit (Option) and motion sensor kit (Option) are connected at the time of shipping from the factory. It is not necessary to disconnect these wiring when wired remote control is connected. When the wired/wireless kits are used together, it becomes necessary to set the slaves and remote control. For the methods of installing the wireless kit and the motion sensor kit, refer to the attached installation manuals.

NOTICE

When installing the Superlink adapter, remove the band fixed the wiring from receiver.

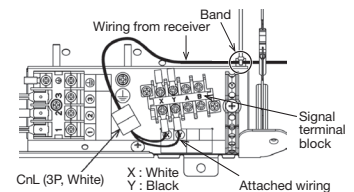

⑦ Wiring-out position and wiring connection (continued)

1. FDE (small) Clip
FDE (medium) Clip
FDE (large) Clip

2. Screw ① Screw ①

3. Control box Sliding Method
Bracket
* Disconnect each wiring from clips before pulling out the control box.

4. Screw ② Lid of control box Screw ②

5 · 6. Single split (PAC) Series
Wireless and motion sensor receiver line (②1)
Remote control line
Wiring between indoor and outdoor unit.
Wiring clamp
Signal side terminal block
Earth terminal block
CnL connector (3P, white)
Power source side terminal block

VRF (KX) Series
Wireless and motion sensor receiver line (②1)
Signal line (Shielded cord)
Remote control line
Indoor power source line
Wiring clamp
Signal side terminal block
Earth terminal block
CnL connector (3P, white)
Power source side terminal block

7 · 8. Control box hook
Screw ② Screw ②
* Install it as to fit the form of control box.

⑧ Control mode switching

- The control content of indoor units can be switched in following way. (is the default setting)

Switch No.	Control Content	
SW8-4	ON	Indoor unit silent mode
	OFF	Normal operation

⑨ Attaching the air return grille

- The air return grille must be attached when electrical cabling work is completed.

- Fix the chains tied to the air return grille onto the indoor unit with screws supplied as accessories (4 pieces).
- Close the air return grille. This completes the unit installation work.

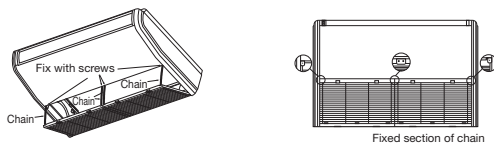

⑩ Check list after installation

- Check the following items after all installation work completed.

Check if	Expected trouble	Check
The indoor and outdoor units are fixed securely?	Falling, vibration, noise	
Inspection for leakage is done?	Insufficient capacity	
Insulation work is properly done?	Water leakage	
Water is drained properly?	Water leakage	
Power source voltage is same as mentioned in the model name plate?	PCB burnt out, not working at all	
There is mis-wiring or mis-connection of piping?	PCB burnt out, not working at all	
Earth wiring is connected properly?	Electric shock	
Cable size comply with specified size?	PCB burnt out, not working at all	
Any obstacle blocks air flow on air inlet and outlet?	Insufficient capacity	

(6) Wall mounted type (SRK)

Model SRK71ZR-W

RLD012A018 

Model SRK63,71,80,100ZR
R32/R410A REFRIGERANT USED

- This installation manual deals with an indoor unit installation only. For an outdoor unit installation, refer to page 107.
- This unit is designed for R32 or R410A. See a label on the outdoor unit to check refrigerant information.

SAFETY PRECAUTIONS

- Before installation, read the "SAFETY PRECAUTIONS" carefully and strictly follow it during the installation work in order to protect yourself.
- The precautionary items mentioned below are distinguished into two levels, **WARNING** and **CAUTION**.
 - WARNING** Indicates a potentially hazardous situation which, if not avoided, can result in serious consequences such as death or severe injury.
 - CAUTION** Indicates a potentially hazardous situation which, if not avoided, can result in personal injury or property damage.
- Both mention the important items to protect your health and safety. Therefore, strictly follow them by any means.
- Be sure to confirm no operation problem on the equipment after completing the installation. If unusual noise can be heard during the test run, consult the dealer.
- Be sure to explain the operating methods as well as the maintenance methods of this equipment to the user according to the user's manual.
- Be sure to keep the installation manual together with user's manual at a place where it is easily accessible to the user any time. Moreover, ask the user to hand the manuals to a new user, whenever required.









WARNING

- **Be sure to use only for residential purpose.**
If this unit is installed in inferior environment such as machine shop, vehicle (like ship), warehouse, etc., it can malfunction.
- **Installation must be carried out by the qualified installer completely in accordance with the installation manual.**
Installation by non qualified person or incorrect installation can cause serious troubles such as water leak, electric shock, fire and personal injury.
- **Be sure to wear protective goggles and gloves while performing installation work.**
Improper safety measures can result in personal injury.
- **Use the original accessories and the specified components for the installation.**
Using parts other than those prescribed may cause water leak, electric shock, fire and personal injury.
- **Do not install the unit near the location where leakage of flammable gases can occur.**
If leaked gases accumulate around the unit, it can cause fire resulting in property damage and personal injury.
- **When installing the unit in small rooms, make sure that refrigerant density does not exceed the limit (Reference: ISO5149) in the event of leakage.**
If refrigerant density exceeds the limit, consult the dealer and install the ventilation system. Otherwise lack of oxygen can occur resulting in serious accident.
- **Install the unit in a location where unit will remain stable, horizontal and free of any vibration transmission.**
Unsuitable installation location can cause the unit to fall resulting in material damage and personal injury.
- **Do not run the unit with removed panels or protections.**
Touching rotating equipments, hot surfaces or high voltage parts can cause personal injury due to entrapment, burn or electric shock.
- **This unit is designed specifically for R32 or R410A.**
Using any other refrigerant can cause unit failure and personal injury.
- **Do not vent R32 or R410A into atmosphere.**
R32 is a fluorinated greenhouse gas with a Global Warming Potential(GWP)=675.
R410A is a fluorinated greenhouse gas with a Global Warming Potential(GWP)=2088.
- **Make sure that no air enters the refrigerant circuit when the unit is installed and removed.**
If air enters the refrigerant circuit, the pressure in the refrigerant circuit will become too high, which can cause burst and personal injury.
- **Be sure to use the prescribed pipes, flare nuts and tools for R32 or R410A.**
Using existing parts (for R22 or R407C) can cause refrigerant circuit burst resulting in unit failure and personal injury.
- **Be sure to connect both liquid and gas connecting pipes properly before operating the compressor.**
Do not open the liquid and gas operation valves before completing piping work, and evacuation.
If the compressor is operated when connecting pipes are not connected and operation valves are open, air can be sucked into the refrigerant circuit which can cause anomalous high pressure resulting in burst or personal injury.
- **Be sure to tighten the flare nuts to specified torque using the torque wrench.**
Tightening flare nuts with excess torque can cause burst and refrigerant leakage after a long period.
- **During pump down work, be sure to stop the compressor before closing operation valves and removing connecting pipes.**
If the connecting pipes are removed when the compressor is in operation and operation valves are open, air can be sucked into the refrigerant circuit which can cause anomalous high pressure resulting in burst or personal injury.
- **In the event of refrigerant leakage during installation, be sure to ventilate the working area properly.**
If the refrigerant comes into contact with naked flames, poisonous gases will be produced.
- **Electrical work must be carried out by the qualified electrician, strictly in accordance with national or regional electricity regulations.**
Incorrect installation can cause electric shock, fire or personal injury.
- **Make sure that earth leakage breaker and circuit breaker of appropriate capacities are installed.**
Circuit breaker should be able to disconnect all poles under over current. Absence of appropriate breakers can cause electric shock, personal injury or property damage.
- **Be sure to switch off the power source in the event of installation, maintenance or service.**
If the power source is not switched off, there is a risk of electric shock, unit failure or personal injury.
- **Be sure to tighten the cables securely in terminal block and relieve the cables properly to prevent overloading the terminal blocks.**
Loose connections or cable mountings can cause anomalous heat production or fire.
- **Do not process, splice or modify the power cable, or share the socket with other power plugs.**
Improper power cable or power plug can cause fire or electric shock due to poor connection, insufficient insulation or over-current.
- **Do not perform any change in protective device or its setup condition yourself.**
Changing protective device specifications can cause electric shock, fire or burst.
- **Be sure to clamp the cables properly so that they do not touch any internal component of the unit.**
If cables touch any internal component, it can cause overheating and fire.
- **Be sure to install service cover properly.**
Improper installation can cause electric shock or fire due to intrusion of dust or water.
- **Be sure to use the prescribed power and connecting cables for electrical work.**
Using improper cables can cause electric leak or fire.
- **This appliance must be connected to main power source by means of a circuit breaker or switch with a contact separation of at least 3mm.**
Improper electrical work can cause unit failure or personal injury.
- **When plugging this unit, a plug conforming to the standard IEC60884-1 must be used.**
Using improper plug can cause electric shock or fire.
- **Be sure to connect the power source cable with power source properly.**
Improper connection can cause intrusion of dust or water resulting in electric shock or fire.

CAUTION

- **Take care when carrying the unit by hand.**
If the unit weight is more than 20kg, it must be carried by two or more persons.
Do not carry the unit by the plastic straps. Always use the carry handle.
- **Do not install the outdoor unit in a location where insects and small animals can inhabit.**
Insects and small animals can enter the electrical parts and cause damage resulting in fire or personal injury. Instruct the user to keep the surroundings clean.
- **If the outdoor unit is installed at height, make sure that there is enough space for installation, maintenance and service.**
Insufficient space can result in personal injury due to falling from the height.
- **Do not install the unit near the location where neighbours are bothered by noise or air generating from the unit.**
It can affect surrounding environment and cause a claim.
- **Do not install in the locations where unit is directly exposed to corrosive gases (like sulphide gas, chloride gas), sea breeze or salty atmosphere.**
It can cause corrosion of heat exchanger and damage to plastic parts.
- **Do not install the unit close to the equipments that generate electromagnetic waves and/or high-harmonic waves.**
Equipment such as inverters, standby generators, medical high frequency equipments and telecommunication equipments can affect the system, and cause malfunctions and breakdowns. The system can also affect medical equipment and telecommunication equipment, and obstruct its function or cause jamming.
- **Do not install the unit in the locations where:**
 - There are heat sources nearby.
 - Unit is directly exposed to rain or sunlight.
 - There is any obstacle which can prevent smooth air circulation from inlet and outlet side of the unit.
 - Unit is directly exposed to oil mist and steam such as kitchen.
 - Chemical substances like ammonia (organic fertilizer), calcium chloride (snow melting agent) and acid (sulfurous acid etc.), which can harm the unit, will generate or accumulate.
 - Drain water can not be discharged properly.
 - TV set or radio receiver is placed within 1m.
 - Height above sea level is more than 1000m.
- **It can cause performance degradation, corrosion and damage of components, unit malfunction and fire.**
- **Dispose of all packing materials properly.**
Packing materials contain nails and wood which can cause personal injury. Keep the polybag away from children to avoid the risk of suffocation.
- **Do not put anything on the outdoor unit.**
Object may fall causing property damage or personal injury.
- **Do not touch the aluminum fin of the outdoor unit.**
Aluminium fin temperature is high during heating operation. Touching fin can cause burn.
- **Do not touch any refrigerant pipe with your hands when the system is in operation.**
During operation the refrigerant pipes become extremely hot or extremely cold depending on the operating condition. Touching pipes can cause personal injury like burn (hot/cold).
- **Install isolator or disconnect switch on the power source wiring in accordance with the local codes and regulations.**
The isolator should be locked in OFF state in accordance with EN60204-1.

1. ACCESSORIES AND TOOLS

Standard accessories (supplied with indoor unit)				Locally procured parts		Tools for installation Work	
(1) Installation board		1pc	(6) Batteries [R03 (AAA, Micro) 1.5V]		2pcs	Plus headed driver	Hole core drill (65mm in diameter)
(2) Remote control		1pc	(7) Air-cleaning filters		2pcs	Knife	Wrench key (Hexagon) [4mm]
(3) Remote control holder		1pc	(8) Filter holders		2pcs	Saw	Flaring tool set*
(4) Tapping screws (for installation board ø4 X 25mm)		10pcs	(9) Insulation (#486 50 X 100 t3)		1pc	Tape measure	Gas leak detector*
(5) Wood screws (for remote control holder ø3.5 X 16mm)		2pcs				Torque wrench (14.9-82.0N·m (1.4-8.2kgf·m))	Pipe bender
						Plier	Gauge for projection adjustment (Used when flare is made by using conventional flare tool)
						Pipe cutter	
							* Designed specifically for R32 or R410A

2. SELECTING INSTALLATION LOCATION

After getting customer's approval, select installation location according to following guidelines.

1. Indoor unit

- Where there is no obstruction to the airflow and where the cooled and heated air can be evenly distributed.
- A solid place where the unit or the wall will not vibrate.
- A place where there will be enough space for servicing. (Where space mentioned on the right side can be secured.)
- Where it is easy to conduct wiring and piping work.
- A place where unit is not directly exposed to sunlight or street light.
- A place where it can be easily drained.
- A place separated at least 1m away from the television or the radio. (To prevent interference to images and sounds.)
- A place where this unit is not affected by the high frequency equipment or electric equipment.
- Avoid installing this unit in place where there is much oil mist.
- A place where there is no electric equipment or household.
- Install the indoor unit on the wall where the height from the floor to the bottom of the unit is more than 180 cm.

2. Remote control

- A place where the air-conditioner can receive the signal surely during operating the remote control.
- A place where it is not affected by the TV, radio etc.
- Do not place where it is exposed to direct sunlight or near heat devices such as a stove.

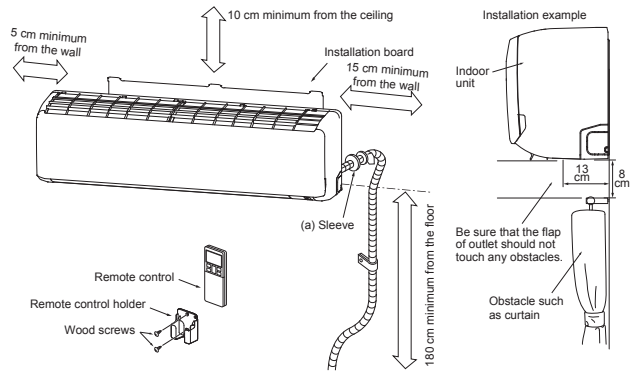

3. INSTALLING INSTALLATION BOARD

- Installation board should be installed on the wall which can support the weight of the indoor unit.
- Adjustment of the installation board in the horizontal direction is to be conducted with 8 screws in a temporary tightened state.
- With the standard hole as a center, adjust the board and level it.

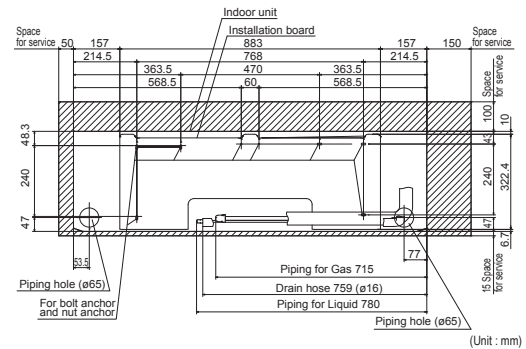
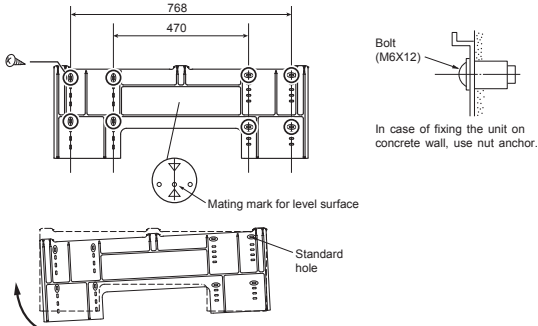

CAUTION
Improper adjustment of the installation board can cause water leakage.

4. DRILLING HOLE AND FIXTURE OF SLEEVE

When drilling the wall that contains a metal lath, wire lath or metal plate, be sure to use sealing plate, sleeve and inclination plate (Locally procured parts).

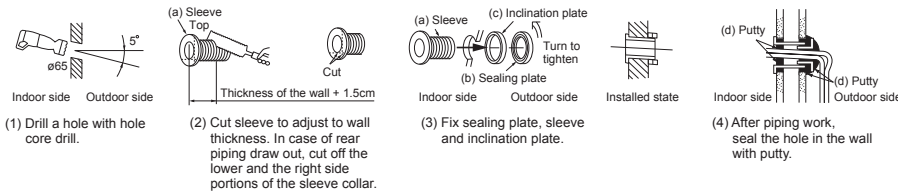

WARNING
Completely seal the hole in the wall with putty. If not sealed properly, dust, insects, small animals, and highly humid air may enter the room from outside, which could result in fire or other hazards.

CAUTION
Completely seal the hole in the wall with putty. If not sealed properly, furniture and other fixtures may be damaged by water leakage or condensation.

5. ELECTRICAL WIRING WORK

- Before installation, make sure that the power source complies with the air-conditioner's power specification.
- Carry out electrical wiring work according to following guidelines.

1. Preparing cable

- (1) Selecting cable
Select the connecting cable in accordance with the specifications mentioned below.
4-core* 1.5mm² conformed with 60245 IEC57
* 1 Earth wire is included (Yellow/Green).
- (2) Arrange each wire length as shown below.
Make sure that each wire is stripped 10mm from the end.

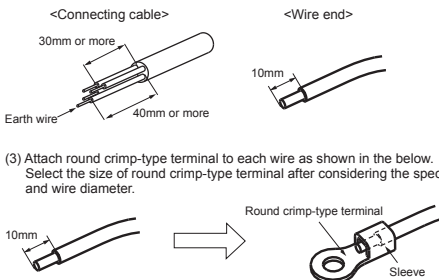

- (3) Attach round crimp-type terminal to each wire as shown in the below.
Select the size of round crimp-type terminal after considering the specifications of terminal block and wire diameter.

2. Connecting cable

- (1) Open the air inlet panel.
- (2) Remove the lid.
- (3) Remove the cable clamp.
- (4) Connect the connecting wires to the terminal block.
- (5) Fix the connecting cable by cable clamp.
- (6) Fix the lid.
- (7) Close the air inlet panel.

NOTE

Take care not to confuse the terminal numbers for indoor and outdoor connections.

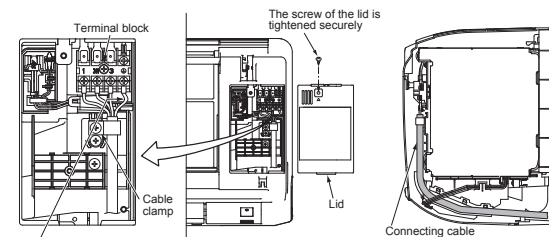

* Earth wire shall be Yellow/Green (Y/G) in color and longer than other AC wires for safety reason.

WARNING
Incorrect wiring connection can cause malfunction or fire.

6. FORMING PIPING AND DRAIN HOSE

1. Forming piping

Piping is possible in the right, rear, downward, left, left rear or left downward direction.

NOTE

Sufficient care must be taken not to damage the panels when connecting pipes.

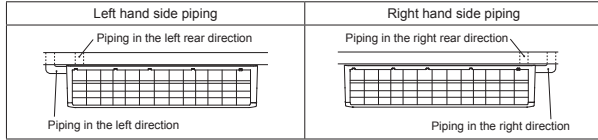
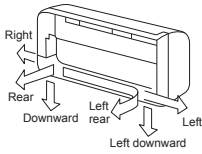

Forming of pipings.

- Hold the bottom of the piping and fix direction before stretching it and shaping it.

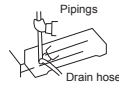

Taping of the exterior

- Tape only the portion that goes through the wall.
- Always tape the wiring with the piping.



2. Drain change procedures

- Remove the screw and drain hose.
- Remove the drain cap by hand or pliers.
- Insert the drain cap which was removed at procedure (2) securely using a hexagonal wrench etc.
- Install the drain hose and screw securely.

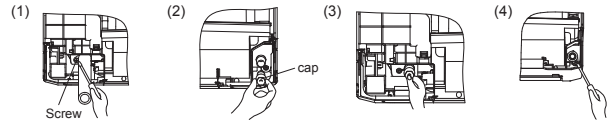

CAUTION

Incorrect installation of drain hose and cap can cause water leakage.

7. DRAINAGE WORK

- Arrange the drain hose in a downward angle.
- Avoid the following drain piping.

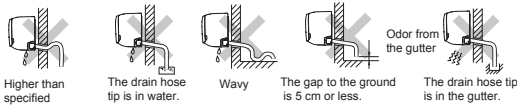

- Pour water to the drain pan located under the heat exchanger, and ensure that the water is discharged outdoor.
- When extended drain hose is present inside the room, insulate it securely with heat insulator available in the market.

Since this air-conditioner is designed to collect dew drops on the rear surface to the drain pan, do not install the connecting wire above the gutter.

CAUTION

Incorrect drainage work can cause water leakage.

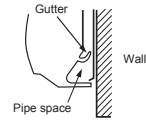

8. INSTALLING INDOOR UNIT

Installing the indoor unit to installation board

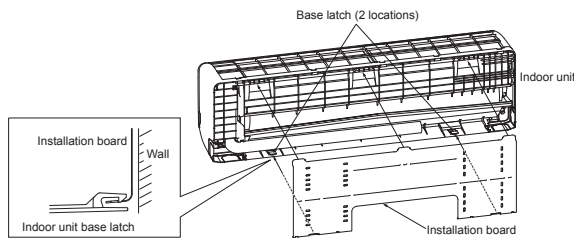

- Pass the pipe through the hole in the wall, and hook the upper part of the indoor unit to the installation board.



- Gently push the lower part to fix the indoor unit base lower latch to installation board.



Removing the indoor unit from installation board

- Push up at the marked portion of the indoor unit base latch, and slightly pull it toward you (both right and left hand sides). (The indoor unit base latch can be removed from the installation board.)
- Push up the indoor unit upward so that it can be removed from installation board.

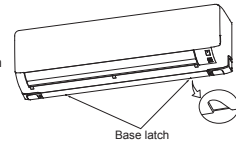

9. CONNECTING PIPING WORK

1. Preparation of connecting pipe

1.1. Selecting connecting pipe

Select connecting pipe according to the following table.

	Model SRK63	Model SRK71/80	Model SRK100
Gas pipe	ø12.7	ø15.88	ø15.88
Liquid pipe	ø6.35	ø6.35	ø9.52

- Pipe wall thickness must be greater than or equal to 0.8 mm (ø15.88:1.0mm).
- Pipe material must be O-type (Phosphorus deoxidized seamless copper pipe ICS 23.040.15, ICS 77.150.30).

1.2. Cutting connecting pipe

- Cut the connecting pipe to the required length with pipe cutter.
- Hold the pipe downward and remove the burrs. Make sure that no foreign material enters the pipe.
- Cover the connecting pipe ends with the tape.

2. Piping work

2.1. Flaring pipe

- Take out flare nuts from the operation valves of indoor unit and engage them onto connecting pipes.
 - Flare the pipes according to table and figure shown below.
- Flare dimensions for R32 are different from those for conventional refrigerant. Although it is recommended to use the flaring tools designed specifically for R32 or R410A, conventional flaring tools can also be used by adjusting the dimension B with a flare adjustment gauge.

Copper pipe outer diameter	A	B [Rigid (clutch) type]	
		R32 or R410A	Conventional
ø6.35	9.1	0-0.5	1.0-1.5
ø9.52	13.2		
ø12.7	16.6		
ø15.88	19.7		

2.2 Connecting pipes

- Connect pipes on both liquid and gas sides.
- Tighten nuts to specified torque shown in the table below.

Service valve size (mm)	Tightening torque (N·m)
ø6.35 (1/4")	14-18
ø9.52 (3/8")	34-42
ø12.7 (1/2")	49-61
ø15.88 (5/8")	68-82

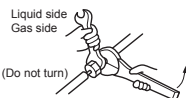

3. Heating and condensation prevention

- Dress the connecting pipes (both liquid and gas pipes) with insulation to prevent it from heating and dew condensation. Use the heat insulating material which can withstand 120°C or higher temperature. Make sure that insulation is wrapped tightly around the pipes and no gap is left between them.
- Wrap the refrigerant pipings of indoor unit with indoor unit heat insulation using tape.
- Cover the flare-connected joints (indoor side) with the indoor unit heat insulation and wrap it with an insulation pad (standard accessory provided with indoor unit).
- Wrap the connecting pipes, connecting cable and drain hose with the tape.

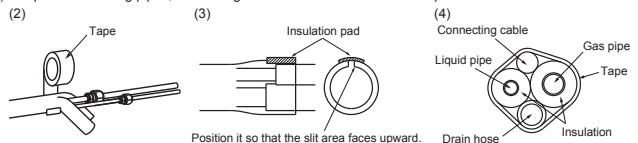

NOTE

Locations where relative humidity exceeds 70%, both liquid and gas pipes need to be dressed with 20mm or thicker heat insulation materials.

CAUTION

- Improper insulation can cause condensate(water) formation during cooling operation. Condensate can leak or drip causing damage to household property.
- Poor heat insulating capacity can cause pipe outer surface to reach high temperature during heating operation. It can cause cable deterioration and personal injury.

4. Finishing work

- Make sure that the exterior portion of connecting pipes, connecting cable and drain hose is wrapped properly with tape. Shape the connecting pipes to match with the contours of the pipe assembly route.
- Fix the pipe assembly with the wall using clamps and screws. Pipe assembly should be anchored every 1.5m or less to isolate the vibration.
- Install the service cover securely. Water may enter the unit if service cover is not installed properly, resulting in unit malfunction and failure.

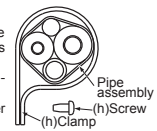

WARNING (only for R32)

- To avoid the risk of fire or explosion, the flared connection must/shall be installed outdoors.
- Reusable mechanical connectors and flared joints are not allowed indoors.

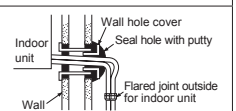

CAUTION

Make sure that the connecting pipes do not touch the components within the unit. If pipes touch the internal components, it may generate abnormal sounds and/or vibrations.

10. HOW TO OPEN, CLOSE, REMOVE AND INSTALL THE AIR INLET PANEL

1. Open

Pull the air inlet panel at both ends of lower part and release latches, then pull up the panel until you feel resistance.
(The panel stops at approx. 60° open position)

2. Close

Hold the panel at both ends of lower part, lower it downward slowly, then push it slightly until the latch works.

3. Removing

Open the panel by 80° (as shown in the right illustration) and then pull it forward.

4. Installing

Insert the panel arm into the slot on the front panel from the position shown in right illustration, hold the panel at both ends of lower part, lower it downward slowly, then push it slightly until the latch works.

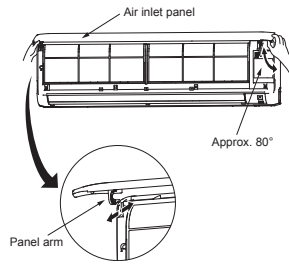

11. HOW TO REMOVE AND INSTALL FRONT PANEL

1. Removing

(1) Remove the air inlet panel and the air filters.
(2) Remove the 8 screws.
(3) Remove the 5 upper latches and then front panel can be removed.

2. Installing

(1) Cover the unit with the front panel and fix 5 upper latches.
(2) Secure the front panel with the 8 screws.
(3) Install the air inlet panel and the air filters.

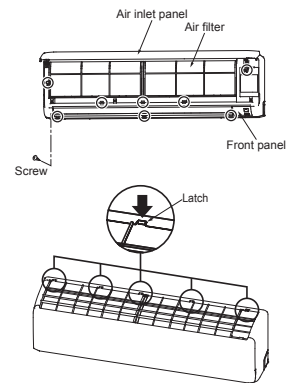

12. INSTALLING REMOTE CONTROL

Mount the batteries

(1) Slide and take out the cover of backside.
(2) Mount the batteries [R03 (AAA, Micro), ×2 pieces] in the body properly.
(Fit the poles with the indication marks + & -)
(3) Set the cover again.

Installing remote control holder

(1) Select the place where the unit can receive signals.
(2) Fix the holder to pillar or wall with wood screws.

NOTE

- Do not use new and old batteries together.
- In case the unit is not operated for a long time, take out the batteries

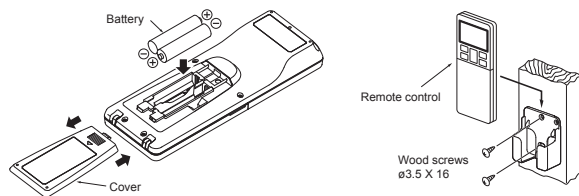

13. TERMINAL CONNECTION FOR AN INTERFACE

To install wired remote control, superlink etc., interface kit is needed.

(1) Remove the air inlet panel and front panel.
(2) Remove the control cover.
(Remove the screw.)
(3) There is a terminal (respectively marked with CNS) for the indoor control board. While connecting an interface, connect to the respective terminal securely with the connection harness supplied with an optional "Interface connection kit SC-BIKN-E and SC-BIKN2-E" and fasten the connection harness onto the indoor control box with the clamp and screw supplied with the kit.
For more details, refer to the user's manual of "Interface connection kit SC-BIKN-E and SC-BIKN2-E".

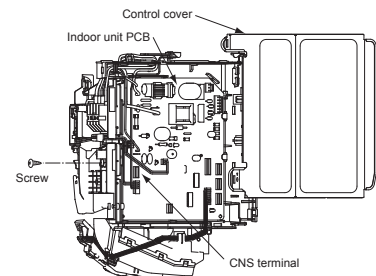

14. INSTALLING TWO AIR-CONDITIONERS IN THE SAME ROOM

In case two air-conditioners are installed in the same room, apply this setting so that one unit can be operated with only one remote control.

Setting one remote control

(1) Slide and take out the cover and batteries.
(2) Cut the switching line next to the battery with wire cutters.
(3) Set the batteries and cover again.

Setting one indoor unit

(1) Turn off the power source and turn it on after 1 minute.
(2) Send the signal by pressing the ACL switch on the remote control that was set according to the procedure described on the left side.
(3) Check that the reception buzzer sound "peep" is emitted from the indoor unit. Since the signal is sent about 6 seconds after the ACL switch is pressed, point the remote control to the indoor unit for a while.

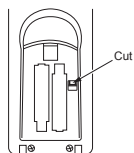

NOTE

If no reception buzzer is emitted, restart the setting from the beginning.

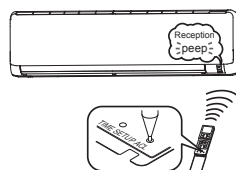

15. PUMP DOWN WORK

For the environmental protection, be sure to pump down when relocating or disposing of the unit. Pump down is the method of recovering refrigerant from the indoor unit to the outdoor unit before the connecting pipes are removed from the unit. When pump down is carried out, forced cooling operation is needed.

Forced cooling operation

(1) Turn off the power source and turn it on again after 1 minute.
(2) Press the ON/OFF button continuously for at least 5 seconds. Then operation will start.

For the detail of pump down, refer to the installation manual of outdoor unit.

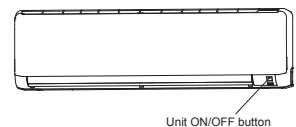

16. INSTALLATION CHECK AND TEST RUN

After finishing the installation work, check the following points again before turning on the power. Conduct a test run and ensure that the unit operates properly. At the same time, explain to the customer how to use the unit and how to take care of the unit following the user's manual.

Before test run

Before test run, check following points.

Power source voltage complies with the rated voltage of air-conditioner.	
Earth leakage breaker and circuit breaker are installed.	
Power cable and connecting cable are securely fixed to the terminal block.	
Both liquid and gas operation valves are fully open.	
No gas leaks from the joints of the operation valves.	
Indoor and outdoor side pipe joints have been insulated.	
Hole on the wall is completely sealed with putty.	
Drain hose and cap are installed properly.	
Screw of the lid is tightened securely.	

Test run

Check following points during test run.

Indoor unit receives signal of remote control.	
Air-conditioning operation is normal.	
There is no abnormal noise.	
Water drains out smoothly.	
Display of remote control is normal.	

After test run

Explain the operating and maintenance methods to the user according to the user's manual.	
Keep this installation manual together with user's manual.	

NOTE

During restart or change in operation mode, the unit will not start operating for approximately 3 minutes. This is to protect the unit and it is not malfunction.

(7) Effective range of cool/hot wind (Reference)

(a) FDT series

Guideline for ceiling height

Fan Speed Setting	Model	
	FDT40VH	FDT71VH
Hi	2.7m	3.0m
P-Hi	3.5m	3.8m

Notes (1) If the ceiling height is over 3m, please consider to add circulators.

This table shows reference values in case of four outlet.

If you shut some outlets, they are different.

Fan speed setting can be changed by using a wired remote control.

(b) FDE series

Model	Effective range
FDE40VH	7.5m
FDE71VH	8.0m







- [Conditions]
1. Height of unit: 2.4 – 3.0 (m) above floor level
 2. Fan speed : Hi
 3. Location: Free space without obstacles
 4. The effective range means the horizontal distance for wind to reach the floor.
 5. Wind speed at the effective range: 0.5 m/s

1.10.2 Electric wiring work installation









PSC012D117 

Electrical wiring work must be performed by an electrician qualified by a local power provider according to the electrical installation technical standards and interior wiring regulations applicable to the installation site.









Security instructions

- Read the "SAFETY PRECAUTIONS" carefully first of all and then strictly follow it during the installation work in order to protect yourself.
- The precautionary items mentioned below are distinguished into two levels,  **WARNING** and  **CAUTION**.
-  **WARNING** : Wrong installation would cause serious consequences such as injuries or death.
-  **CAUTION** : Wrong installation might cause serious consequences depending on circumstances. Both mentions the important items to protect your health and safety so strictly follow them by any means.
- The meanings of "Marks" used here are as shown on the right:
 Never do it under any circumstances.  Always do it according to the instruction.
- Accord with following items. Otherwise, there will be the risks of electric shock and fire caused by overheating or short-circuit.

WARNING

- Be sure to have the electric wiring work done by qualified electrical installer, and use exclusive circuit. 
Power source with insufficient capacity and improper work can cause electric shock and fire.
- Use specified wire for electrical wiring, fasten the wiring to the terminal securely, and hold the cable securely in order not to apply unexpected stress on the terminal. 
Loose connections or hold could result in abnormal heat generation or fire.
- Arrange the electrical wires in the control box properly to prevent them from rising. Fit the lid of the services panel properly. 
Improper fitting may cause abnormal heat and fire.
- Use the genuine option parts. And installation should be performed by a specialist. 
If you install the unit by yourself, it could cause water leakage, electric shock and fire.
- Do not repair by yourself. And consult with the dealer about repair. 
Improper repair may cause water leakage, electric shock or fire.
- Consult the dealer or a specialist about removal of the air-conditioner. 
Improper installation may cause water leakage, electric shock or fire.
- Turn off the power source during servicing or inspection work. 
If the power is supplied during servicing or inspection work, it could cause electric shock and injury by the operating fan.
- Shut off the power before electrical wiring work. 
It could cause electric shock, unit failure and improper running.

CAUTION

- Perform earth wiring surely. 
Do not connect the earth wiring to the gas pipe, water pipe, lightning rod and telephone earth wiring. Improper earth could cause unit failure and electric shock due to a short-circuit.
- Earth leakage breaker must be installed. 
If the earth leakage breaker is not installed, it can cause electric shocks.
- Make sure to install earth leakage breaker on power source line. (countermeasure thing to high harmonics.) 
Absence of breaker could cause electric shock.
- Use the circuit breaker of correct capacity. Circuit breaker should be the one that disconnect all poles under over current. 
Using the incorrect one could cause the system failure and fire.
- Do not use any materials other than a fuse of correct capacity where a fuse should be used. 
Connecting the circuit by wire or copper wire could cause unit failure and fire.
- Use power source line of correct capacity. 
Using incorrect capacity one could cause electric leak, abnormal heat generation and fire.
- Do not mingle solid cord and stranded cord on power source and signal side terminal block. 
In addition, do not mingle difference capacity solid or stranded cord. Inappropriate cord setting could cause loosening screw on terminal block, bad electrical contact, smoke and fire.
- Do not turn off the power source immediately after stopping the operation. 
Be sure to wait for more than 5 minutes. Otherwise it could cause water leakage or breakdown.
- Do not control the operation with the circuit breaker. 
It could cause fire or water leakage. In addition, the fan may start operation unexpectedly and it may cause injury.

Control mode switching

- The control content of indoor units can be switched in following way. ( is the default setting)

Switch No.	Control Content	
SW2	Indoor unit address (0-Fh)	
SW5-1	Master/Slave Switching (plural /Slave unit Setting)	
SW5-2		
SW6-1~4	Model capacity setting	
SW7-1	ON	Operation check, Drain motor test run
	OFF	Normal operation

① Electrical wiring connection

- Electrical wiring work must be performed by an electrician qualified by a local power provider. These wiring specifications are determined on the assumption that the following instructions are observed:

- ① Do not use cords other than copper ones.
Do not use any source line lighter than one specified in parentheses for each type below.
 -braided cord (code designation 60245 IEC 51), if allowed in the relevant part 2;
 -ordinary tough rubber sheathed cord (code designation 60245 IEC 53);
 -flat twin tinsel cord (code designation 60227 IEC 41);
 -ordinary polyvinyl chloride sheathed cord (code designation 60227 IEC 53);
- ② Connect the power source to the outdoor unit.
- ③ Pay extra attention so as not to confuse signal line and power source line connection, because an error in their connection can be burn all the boards at once.

- Connect ground wires before connecting wires between the indoor and outdoor units and between indoor units. The ground wires need to be longer than the wires between the indoor and outdoor units, and protected from undue stress.

- Do not turn on the power source before completing the work.
- The ground wires must be connected by the Class D grounding connection. 
- Use the round crimp terminals for connections to the terminal block.
- Use dedicated branch circuits, avoiding combination with other devices. Otherwise, it could trip the power source breaker, resulting in secondary accidents.
- Install the overcurrent and earth leakage breakers (sensitivity current: 30 mA) specified to respective models.

- Do not connect indoor and outdoor signal cables to extension cables on the way. If the joint is wetted with intruding water, it could cause a ground insulation failure or poor connection, resulting in communication errors. (If it is inevitable to connect cables on the way, make sure to prevent the water intrusion completely.)

- When running wires (wires for power source, remote controller, connecting between indoor and outdoor units, or other) behind the ceiling, protect them using copper or other pipes against assault by rat, or other.

- It is up to 3.5 mm² the size of power supply cables connected to indoor units. When using cables of 5.5 mm² or larger, provide a dedicated pull box for branching connection to indoor units.

- If signal and power source cables are connected mistakenly, it could burn down all PCBs.

- ① Even if the power source of 220/240/380/415 V is connected mistakenly to A-B signal cable, it is protected at initial occasion only.
- ② If the remote control fails to detect the unit No. (address) at 15 minutes after turning the power on, check and repair all signal cables for misconnection.

- ③ Cut the jumper wire J10S1 of burnt PCB, and reconnect connectors CnK (yellow) and CnK1 (white) to CnK2 (black).
- ④ If any anomaly is found on wires between the A-B terminal block and the PCB, replace them.

- At the outside of indoor and outdoor units, take care to avoid direct contacts between remote control and power source cables.

- In no event connect the power source of 220/240/380/415 V to the remote control terminal block. It could cause failures.

- Connections of wiring between units, ground wire and remote control cable

- ① When connecting wires between units, ground wire or remote control wire, connect them according to the number of terminals on the power source terminal block or signal terminal block in the control box. Connect the ground wire to the ground terminal on the power source terminal block.

- ② Make sure to install an earth leakage breaker for the power source. Select a breaker for inverter circuit.

- ③ When the earth leakage breaker is exclusive for the earth leakage protection, it is necessary to connect also an isolating switch (Switch + Class B fuse) or wiring circuit breaker in series to the earth leakage breaker.
- ④ Install the isolating switch close to the unit.

- Connect wires securing by tightening screws firmly. Confirm also no connector or wire (from terminal) is disconnected in the control box.

- When installing an auxiliary electric heater, consult the electric heater manual or technical data.

Cable connection for single unit installation



- ① As for connecting method of power source, select from following connecting patterns. In principle, do not directly connect power source line to inside unit.

- ※ As for exceptional connecting method of power source, discuss with the power provider of the country with referring to technical documents, and follow its instruction.

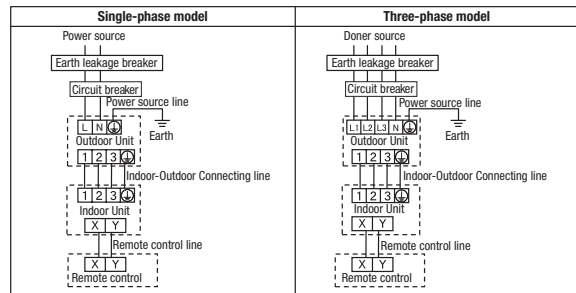
- ② For cable size and circuit breaker selection, refer to the outdoor unit installation manual.



Cable connection for a V multi configuration installation

- ① Connect the same pairs number of terminal block "①", "②", and "③" and "ⓧ" and "Ⓞ" between master and slave indoor units.
- ② Do the same address setting of all inside units belong to same refrigerant system by rotary switch SW2 on indoor unit's PCB (Printed circuit board).
- ③ Set slave indoor unit as "slave 1" through "slave 3" by address switch SW5-1, 5-2 on PCB.
- ④ When the [AIR CON NO.] button on the remote control unit is pressed after turning on the power, an indoor unit's address number will be displayed. Do not fail to confirm that the connected indoor unit's numbers are displayed on the remote control unit by pressing the  or  button.

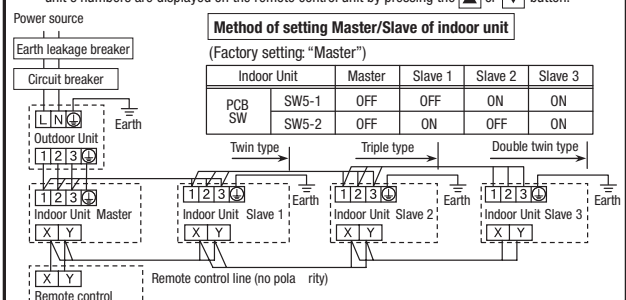

② Remote control, wiring and functions

● Do not install it on the following places

- ① Places exposed to direct sunlight
- ② Places near heat devices
- ③ High humidity places
- ④ Hot surface or cold surface enough to generate condensation
- ⑤ Places exposed to oil mist or steam directly.
- ⑥ Uneven surface

Installation and wiring of remote control

- ① Install remote control referring to the attached installation manual.
- ② Wiring of remote control should use 0.3mm² × 2 core wires or cables.
The insulation thickness is 1mm or more. (on-site configuration)
- ③ Maximum prolongation of remote control wiring is 600 m.
If the prolongation is over 100m, change to the size below.
But, wiring in the remote control case should be under 0.5mm². Change the wire size outside of the case according to wire connecting. Waterproof treatment is necessary at the wire connecting section. Be careful about contact failure.
100 - 200m 0.5mm² × 2 cores
Under 300m 0.75mm² × 2 cores
Under 400m 1.25mm² × 2 cores
Under 600m 2.0mm² × 2 cores
- ④ Avoid using multi-core cables to prevent malfunction.
- ⑤ Keep remote control line away from earth (frame or any metal of building).
- ⑥ Make sure to connect remote control line to the remote control and terminal block of indoor unit. (No polarity)

Control plural indoor units by a single remote control

- ① A remote control can control plural indoor units (Up to 16).
- In above setting, all plural indoor units will operate under same mode and temperature setting.
- ② Connect all indoor units with 2 core remote control line.
- ③ Set unique remote control communication address from "0" to "F" to each inside unit by the rotary switch SW2 on the indoor unit's PCB.

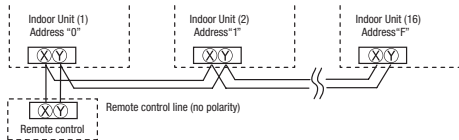

Master/ slave setting when more than one remote control unit are used

A maximum of two remote control units can be connected to one indoor unit (or one group of indoor units.)
The air-conditioner operation follows the last operation of the remote control regardless of the master/slave setting of it.
Acceptable combination is "two (2) wired remote controls", "one (1) wired remote control and one (1) wireless kit" or "two (2) wireless kits".
Set one to "Master" and the other to "Slave".
Note: The setting "Remote control unit sensor enabled" is only selectable with the master remote control unit in the position where you want to check room temperature.

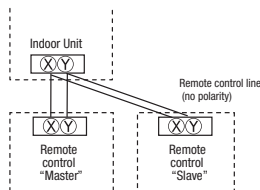

③ Operation and confirmation from remote control

No.	Item	Operation from the eco touch remote control (RC-EX series)	Operation from the standard remote control (RC-E series)
1	Check the number of units connected in the multi remote control system.	[Menu] ⇒ [Service setting] ⇒ [Service & Maintenance] ⇒ [Service password] ⇒ [IU address]	① Press the [AIR CON NO] button to display the IU address. ② Press the [▲] or [▼] button and check addresses of connected indoor units one by one.
2	Check if each unit is connected properly in the remote control system.	[Menu] ⇒ [Service setting] ⇒ [Service & Maintenance] ⇒ [Service password] ⇒ [IU address] ⇒ [Check run mode]	① Press the [AIR CON NO] button to display the IU address. ② Press the [▲] or [▼] button and select one of IU addresses. ③ Press the [MODE] button. The unit starts to blow air.
3	Setting main/sub remote controls	[Menu] ⇒ [Service setting] ⇒ [R/C function settings] ⇒ [Service password] ⇒ [Main/Sub of R/C]	Set SW1 to "Sub" for the sub remote control unit.
4	Checking operation data	[Menu] ⇒ [Service setting] ⇒ [Service & Maintenance] ⇒ [Service password] ⇒ [Operation data]	Press the [CHECK] button. ⇒ "DIFFER DATA ▼" is displayed. ⇒ Press the [SET] button. ⇒ "DATA LOADING" is displayed. ⇒ Select one of addresses for connected indoor units by pressing the [▲] or [▼] button. ⇒ Press the [SET] button. ⇒ "DATA LOADING" is displayed. ⇒ Select data by pressing the [▲] or [▼] button.
5	Checking inspection display	[Menu] ⇒ [Service setting] ⇒ [Service & Maintenance] ⇒ [Service password] ⇒ [Error display]	Press the [CHECK] button. ⇒ "DIFFER DATA ▼" is displayed. ⇒ Press the [▼] button. ⇒ "ERRR DATA ▲" is displayed. ⇒ Press the [SET] button. ⇒ "DATA LOADING" is displayed. ⇒ Data is displayed.
6	Cooling test run from remote control	[Menu] ⇒ [Service setting] ⇒ [Installation settings] ⇒ [Service password] ⇒ [Test run] ⇒ [Cooling test run] ⇒ [Start]	① Start the system by pressing the [ON/OFF] button. ② Select "*(Cool)" with the [MODE] button. ③ Press the [TEST] button for 3 seconds or longer. The screen display will switch to "*(TEST RUN ▼)". ④ Pressing the [SET] button, while the "*(TEST RUN ▼)" is displayed, starts the cooling test run. The screen display will switch to "*(TEST RUN ▼)".
7	Trial operation of drain pump from remote control	[Menu] ⇒ [Service setting] ⇒ [Installation settings] ⇒ [Service password] ⇒ [Test run] ⇒ [Drain pump test run] ⇒ [Run]	① Start the system by pressing the [ON/OFF] button. The display will change to "*(TEST RUN ▼)". ② Press the [▼] button once to display "DRAIN PUMP ▲". ③ Pressing the [SET] button starts the drain pump operation. The display will show "*(DRAIN PUMP ▲)".

The menu configuration may vary depending on models of the remote control. If the model of your remote control is different, refer to the installation manual attached to the remote control.

④ Function of CnT connector of indoor printed circuit board

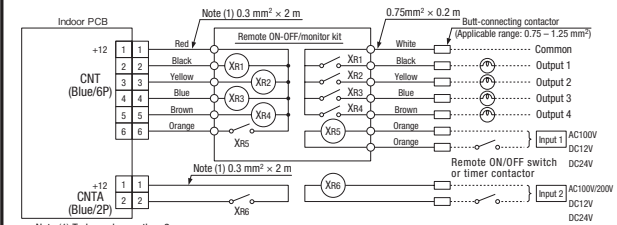

- XR1-4 are DC 12 V relays. (Equivalent to Omron's LY2F)
- XR5 is a DC 12 V, 24 V or 100 V, 200 V relay. (Equivalent to Omron's MY2F)
- Maker and model of CnT connector (Site side)
Connector : Molex 5264-06
Terminal : Molex 5263T
- CnTA connector is used on FDT, or other. <Check with the specifications.> (Site side) Maker and model
Connector : J.S.T. Mfg. XAP02V-1-E
Terminal : J.S.T. Mfg. SXA-01T-P0.6
- Output 1 - 4 and input1/2 can be selected/set as required from following items.
Factory default is set as shown below.

Output	
① RUN output	⑧ Fan ON output 3
② Heating output	⑨ Defrost/oil return output
③ Compressor ON output	⑩ Ventilation output
④ Inspection (error) output	⑪ Heater output
⑤ Cooling output	⑫ Free cleaning output
⑥ Fan ON output 1	⑬ Indoor overload error output
⑦ Fan ON output 2	

Input	
① RUN/STOP	⑤ Setting temp. shift
② RUN permit prohibition	⑥ Compulsory thermostat OFF
③ Emergency stop	⑦ Temporary stop
④ Cooling/Heating	⑧ Silent mode

Factory default setting			
CnT-2 Output 1	RUN output	CnT-5 Output 4	Inspection (error) output
CnT-3 Output 2	Heating output	CnT-6 Input 1	RUN/STOP
CnT-4 Output 3	Compressor ON output	CnTA Input 2	RUN/STOP

● For the setting method, refer to the technical data.

⑤ Operation and setting from remote control

A : Refer to the instruction manual for RC-EX series ○ : Nearly same function setting and operations are possible. *1: Remote controls before RC-EX1A don't have this function.
 B : Refer to the installation manual for RC-EX series △ : Similar function setting and operations are possible. *2: Remote controls before RC-EX3 don't have this function.
 C : Loading a utility software via Internet

Setting & display item	Description	RC-EX3A	RC-E5	
1.Remote Control network				
1 Control plural indoor units by a single remote control	A remote control can control plural indoor units up to 16 (in one group of remote control network). An address is set to each indoor unit.		○	
2 Main/sub setting of remote controls	A pair of remote controls (including option wireless remote control) can be connected within the remote control network. Set one to "Main" and the other to "Sub".	B	○	
2.TOP screen, Switch manipulation				
1 Menu	"Control", "State", or "Details" can be selected. (3-8)	A		
2 Operation mode	"Cooling", "Heating", "Fan", "Dry" or "Auto" can be set.	A	○	
3 Set temp.	"Set temperature" can be set by 0.5°C interval.	A	○	
4 Air flow direction	"Air flow direction" (Individual flap control) can be set. Select Enable or Disable for the "3D AUTO" (in case of FDK). *1	A	△	
5 Fan speed	"Fan speed" can be set.	A	○	
6 Timer setting	"Timer operation" can be set.	A	○	
7 ON/OFF	"On/Off operation of the system" can be done.	A	○	
8 F1 SW	*1 The system operates and is controlled according to the function specified to the F1 switch.	A		
9 F2 SW	*1 The system operates and is controlled according to the function specified to the F2 switch.	A		
10 Select the language	*2 Select the language to display on the remote control. • Select from English, German, French, Spanish, Italian, Dutch, Turkish, Portuguese, Russian, Polish, Japanese and Chinese.	A		
3.Useful functions				
1 Individual flap control	The moving range (the positions of upper limit and lower limit) of the flap for individual flap can be set. Set also the left and right limit positions for FDK. *1	A	△	
2 Anti draft setting When the panel with the anti-draft function is assembled.	*1 • DetailsYou can set Enable or Disable for anti draft motion performed at each blow outlet in each operation mode. • ON/OFF settingYou can set ON/OFF (operation/stop) of anti draft function for the enabled blow outlet set in Details. *2	A		
3 Timer settings	Set On timer by hour	The period of time to start operation after stopping can be set. • The period of set time can be set within range of 1hour-12hours (1hr interval). • The operation mode, set temp-and fan speed at starting operation can be set.	A	△
	Set Off timer by hour	The period of time to stop operation after starting can be set. • The period of set time can be set within range of 1hour-12hours (1hr interval).	A	△
	Set On timer by clock	The clock time to start operation can be set. • The set clock time can be set by 5-minutes intervals. • [Once (one time only)] or [Everyday] operation can be switched. • The operation mode, set temp. and fan speed at starting operation can be set.	A	△
	Set Off timer by clock	The clock time to stop operation can be set. • The set clock time can be set by 5-minute intervals. • [Once (one time only)] or [Everyday] operation can be switched.	A	△
	Confirmation of timer settings	Status of timer settings can be seen.	A	
4 Favorite setting [Administrator password]	*1 Set the operation mode, setting temperature, air flow capacity and air flow direction for the choice setting operations. Set them for the Favorite set 1 and the Favorite set 2 respectively.	A		
5 Weekly timer	On timer and Off timer on weekly basis can be set. • 8-operation patterns per day can be set at a maximum. • The setting clock time can be set by 5-minute intervals. • Holiday setting is available. • The operation mode, set temp. and fan speed at starting operation can be set.	A	△	
6 Home leave mode [Administrator password]	When leaving home for a long period like a vacation leave, the unit can be operated to maintain the room temperature not to be hotter in summer or not to be colder in winter. • The judgment to switch the operation mode (Cooling ⇄ Heating) is done by the both factors of the set temp. and outdoor air temp. • The set temp. and fan speed can be set.	A		
7 External Ventilation When the ventilator is combined.	On/Off operation of the external ventilator can be done. It is necessary to set from [Menu] ⇒ [Service setting] ⇒ [R/C function settings] ⇒ [Ventilation setting]. • If the "Independent" is selected for the ventilation setting, the ventilator can be operated or stopped.	A	○	
8 Select the language	Select the language to display on the remote control. • Select from English, German, French, Spanish, Italian, Dutch, Turkish, Portuguese, Russian, Polish, Japanese and Chinese. *1	A		
9 Silent mode control	*2 The period of time to operate the unit by prioritizing the quietness can be set. • Start and end can be set for the silent mode	A		
4.Energy-saving setting				
Administrator password				
1 Sleep timer	To prevent the timer from keeping ON, set hours to stop operation automatically with this timer. • The selectable range of setting time is from 30 to 240 minutes. (10-minute intervals) • When setting is "Enable", this timer will activate whenever the ON timer is set.	A	△	
2 Peak-cut timer	Power consumption can be reduced by restructuring the maximum capacity. Set the [Start time], the [End time] and the capacity limit % (Peak-cut %). • 4-operation patterns per day can be set at maximum. • The setting time can be changed by 5-minute intervals. • The selectable range of capacity limit % (Peak-cut %) is from 0% to 40-80% (20% interval) • Holiday setting is available.	A		
3 Automatic temp set back	After the elapse of the set time period, the current set temp. will be set back to the [Set back time.] • The setting can be done in cooling and heating mode respectively. • Selectable range of the set time is from 20 min. to 120 min. (10 min. interval). • Set the [Set back temp.] by 1°C interval.	A	△	
4 Motion sensor control When the panel with the motion sensor is assembled.	*1 When the motion sensor is used, it is necessary to set Enable or Disable for the "Power control" and the "Auto-off".	A		
5.Filter				
1 Filter sign reset	Filter sign reset	The filter sign can be reset.	A	
	Setting next cleaning date	The next cleaning date can be set.	A	
6.User setting				
1 Internal settings	Clock setting	The current date and time can be set or revised. • If a power failure continues no longer than 80 hours, the clock continues to tick by the built-in power source.	A	△
	Date and time display	[Display] or [Hide] the date and/or time can be set, and [12H] or [24H] display can be set.	A	
	Summer time	When select [Enable], the +1-hour adjustment of current time can be set. When select [Disable], the [Summer time] adjustment can be reset.	A	
	Contrast	The contrast of LCD can be adjusted higher or lower.	A	
	Backlight	Switching on/off a light can be set and period of the lighting time can be set within the range of 5sec-90 sec (5sec interval).	A	
	Control sound	It can set with or without [Control sound (beep sound)] at touch panel.	A	
	Operation lamp luminance	*1 This is used to adjust the luminance of operation lamp.	A	
2 Administrator settings [Administrator password]	Permission/Prohibition setting	• Permission/Prohibition setting of operation can be set. [On/Off] [Change set temp] [Change operation mode] [Change flap direction] [Change fan speed] [High power operation] [Energy-saving operation] [Timer] Request for administrator can be set. [Individual flap control] [Weekly timer] [Select the language] [Anti draft setting] *1	A	△
	Outdoor unit silent mode timer	The period of time to operate the outdoor unit by prioritizing the quietness can be set. • The [Start time] and the [End time] for operating outdoor unit in silent mode can be set. • The period of the operation time can be set once a day by 5-minute intervals.	A	△
	Setting temp. range	The upper/lower limit of temp. setting range can be set. • The limitation of indoor temp. setting range can be set for each operation mode in cooling and heating.	A	△

⑤ Operation and setting from remote control (continued)

Setting & display item	Description	RC-EX3A	RC-E5		
2 Administrator settings [Administrator password]	Temp increment setting	The temp increment setting can be changed by 0.5°C or 1.0°C.	A		
	Set temp display	Ways of displaying setting temperatures can be selected.	A		
	R/C display setting	Register [Room name] [Name of I/U] Display [Indoor temp display] or not. Display [Error code display] or not. Display [Heating stand-by display] [Defrost operation display] [Auto cooling/heating display] [Display temp of R/C, Room, Outdoor] or not	A	△	
	Change administrator password	The administrator password can be changed. (Default setting is "0000") The administrator password can be reset.	A B		
	F1/F2 function setting *1	Functions can be set for F1 and F2. Selectable functions: [Anti draft ON/OFF] *2 [High power operation], [Energy-saving operation], [Silent mode cont.], [Home leave mode], [Favorite set 1], [Favorite set 2] and [Filter sign reset].	A		
7. Service setting					
1 Installer settings [Service password]	Installation date	The [Installation date] can be registered. • When registering the [Installation date], the [Next service date] is displayed automatically. (For changing the [Next service date], please refer the item of [Service & Maintenance])	B		
	Company information	The [Company information] can be registered and can be displayed on the R/C. • The [Company] can be registered within 26 characters. • The [Phone No.] can be registered within 13 digits.	B		
	Test run	On/Off operation of the test run can be done.			
		Cooling test run	The [Cooling test run] can be done at 5°C of set temp. for 30 minutes.	B	○
	Drain pump test run	Only drain pump can be operated.			
	Static pressure adjustment	In case of combination with only the ducted indoor unit which has a function of static pressure adjustment, the static pressure is adjustable. • It can be set for each indoor unit individually.	B		
	Change auto-address	The set address of each indoor unit decided by auto-address setting method can be changed to any other address. (For multiple KX units only)	B	△	
	Address setting of main IU	Main indoor unit address can be set. • Only the Main indoor unit can change operation mode and the Sub indoor units dominated by the Main indoor shall follow. • The Main indoor unit can domain 10 indoor units at a maximum.	B	△	
	IU back-up function	When a pair of indoor units (2 groups) is connected to one unit of remote control, it can be set Enable or Disable for the [IU rotation], [IU capacity back-up] and [IU fault back-up]	B		
	Motion sensor setting *1	Set Enable or Disable for the infrared sensor detectors of indoor units connected to the remote control. If Disable is selected, it cannot be control the motion sensor control for the energy-saving setting.	B		
2 R/C function setting [Service password]	Main/Sub R/C	The R/C setting of [Main/Sub] can be changed.	B	○	
	Return air temp	When two or more indoor units are connected to one unit of remote control, suction sensors, which are used for the judgement by thermostat, can be selected. • It can be selected from [Individual], [Master IU] and [Average temp].	B		
	R/C sensor	It can be set the mode to switch to the remote control sensor. It can be selected from cooling and heating.	B	△	
	R/C sensor adjustment	The offset value of [R/C sensor] sensing temp. can be set respectively in heating and cooling.	B	△	
	Operation mode	Enable or Disable can be set for each operation mode.	B	△	
	°C / °F	Set the unit for setting temperatures. • °C or °F can be selected.	B		
	Fan speed	Fan speeds can be selected.	B	○	
	External input	When two or more indoor units are connected to one unit of remote control, the range to apply CNT inputs can be set.	B	○	
	Upper/lower flap control	[Stop at fixed position] or [Stop at any position] can be selected for the upper and lower louvers.	B	○	
	Left/right flap control *1	[Fixed position stop] or [Stop at any position] can be selected for the right and left louvers.	B		
	Ventilation setting	Combination control for ventilator can be set.	B	○	
	Auto-restart	The operation control method after recovery of power failure happened during operation can be set.	B	○	
	Auto temp setting	[Enable] or [Disable] of [Auto temp setting] can be selected.	B		
	Auto fan speed	[Enable] or [Disable] of [Auto fan speed] can be selected.	B		
	3 IU settings [Service password]	Fan speed setting	The fan speed for indoor units can be set.	B	○
Filter sign		The setting of filter sign display timer can be done from following patterns.	B	○	
External input 1		The connect of control by external input 1 can be changed.	B	○	
External input 1 signal		The type of external input 1 signal can be changed.	B	○	
External input 2		The connect of control by external input 2 can be changed.	B		
External input 2 signal		The type of external input 2 signal can be changed.	B		
Heating thermo-OFF temp adjustment		The judgement temp. of heating thermo-off can be adjusted within the range from 0 to +3°C (1°C interval)	B	△	
Return temperature adjustment		The sensing temp. of return air temp. sensor built in the indoor unit can be adjusted within the range of ±2°C.	B	△	
Fan control in cooling thermo-OFF		Fan control, when the cooling thermostat is turned OFF, can be changed.	B	○	
Fan control in heating thermo-OFF		Fan control, when the heating thermostat is turned OFF, can be changed.	B	○	
Anti-frost temp		Judgment temperature for the anti-frost control during cooling can be changed.	B	○	
Anti-frost control		When the anti-frost control of indoor unit in cooling is activated, the fan speed can be changed.	B	○	
Drain pump operation		In any operation mode in addition to cooling and dry mode, the setting of drain pump operation can be done.	B	○	
Keep fan operating after cooling is stopped		The time period residual fan operation after stopping or thermo-off in cooling mode can be set.	B	○	
Keep fan operating after heating is stopped		The time period residual fan operation after stopping or thermo-off in heating mode can be set.	B	○	
Intermittent fan operation in heating		The fan operation rule following the residual fan operation after stopping or thermo-off in heating mode can be set.	B	○	
Fan circulator operation		In case that the fan is operated as the circulator, the fan control rule can be set.	B		
Control pressure adjust		When only the OA processing units are operated, control pressure value can be changed.	B		
Auto operation mode	The [Auto rule selection] for switching the operation mode automatically can be selected from 3 patterns.	B			
Thermo. rule setting	When selecting [Outdoor air temp. control], the judgment temp can be offset by outdoor temp..	B			
Auto fan speed control	Auto switching range for the auto fan speed control can be set.	B			
IU overload alarm	If the difference between the setting temperature and the suction temperature becomes larger than the temperature difference set for the overload alarm, at 30 minutes after the start of operation, the overload alarm signal is transmitted from the external output (CNT-5).	B			
External output setting *1	Functions assigned to the external outputs 1 to 4 can be changed.	B			
4 Service & Maintenance [Service password]	IU address	Max 16 indoor units can be connected to one remote control, and all address No. of the connected indoor units can be displayed. • The indoor unit conforming to the address No. can be identified by selecting the address No. and tapping [Check] to operate the indoor fan.	B	○	
	Next service date	The [Next service date] can be registered. • The [Next service date] and [Company information] is displayed on the message screen.	A B	○	
	Operation data	The [Operation data] for indoor unit and outdoor unit can be displayed.	B	○	
	Error display	Error history	The error history can be displayed.		
		Display anomaly data	The operation data just before the latest error stop can be displayed.	B	△
		Erase anomaly data	Anomaly operation data can be erased.		
		Reset periodical check	The timer for the periodical check can be reset.		
	Saving IU settings	The [IU settings] memorized in the indoor PCB connected to the remote control can be saved in the memory of the remote control.	B		
Special settings	[Erase IU address] [CPU reset] [Restore of default setting] [Touch panel calibration]	B	△		
Indoor unit capacity display *1	Address No. and capacities of indoor units connected to the remote control are displayed.	B			
8. Contact company					
9. Inspection					
[Confirmation of Inspection]	This is displayed when any error occurs.	A	△		
10. PC connection					
[USB connection]	Weekly timer setting and etc., can be set from PC.	C			



◆ Listed items may not function depending on the specifications of indoor and outdoor units which are combined.

1.10.3 Installation of wired remote control (Option parts)

(1) Model RC-EX3A

1) Safety precautions

- Please read this manual carefully before starting installation work to install the unit properly. Every one of the followings is important information to be observed strictly.

 WARNING	Failure to follow these instructions properly may result in serious consequences such as death, severe injury, etc.
 CAUTION	Failure to follow these instructions properly may cause injury or property damage.

It could have serious consequences depending on the circumstances.

- The following pictograms are used in the text.

 Never do.	 Always follow the instructions given.
---	---

- Keep this manual at a safe place where you can consult with whenever necessary. Show this manual to installers when moving or repairing the unit. When the ownership of the unit is transferred, this manual should be given to a new owner.

WARNING



Consult your dealer or a professional contractor to install the unit.

Improper installation made on your own may cause electric shocks, fire or dropping of the unit.



Installation work should be performed properly according to this installation manual.

Improper installation work may result in electric shocks, fire or break-down.



Be sure to use accessories and specified parts for installation work.

Use of unspecified parts may result in drop, fire or electric shocks.



Install the unit properly to a place with sufficient strength to hold the weight.

If the place is not strong enough, the unit may drop and cause injury.



Be sure to have the electrical wiring work done by qualified electrical installer, and use exclusive circuit.

Power source with insufficient and improper work can cause electric shock and fire.



Shut OFF the main power source before starting electrical work.

Otherwise, it could result in electric shocks, break-down or malfunction.



Do not modify the unit.

It could cause electric shocks, fire, or break-down.



Be sure to turn OFF the power circuit breaker before repairing/ inspecting the unit.

Repairing/inspecting the unit with the power circuit breaker turned ON could cause electric shocks or injury.

 **WARNING**

Do not install the unit in appropriate environment or where inflammable gas could generate, flow in, accumulate or leak.



If the unit is used at places where air contains dense oil mist, steam, organic solvent vapor, corrosive gas (ammonium, sulfuric compound, acid, etc) or where acidic or alkaline solution, special spray, etc. are used, it could cause electric shocks, break-down, smoke or fire as a result of significant deterioration of its performance or corrosion.



Do not install the unit where water vapor is generated excessively or condensation occurs.

It could cause electric shocks, fire, or break-down.



Do not use the unit in a place where it gets wet, such as laundry room.

It could cause electric shocks, fire, or break-down.



Do not operate the unit with wet hands.

It could cause electric shocks.



Do not wash the unit with water.

It could cause electric shocks, fire, or break-down.



Use the specified cables for wiring, and connect them securely with care to protect electronic parts from external forces.

Improper connections or fixing could cause heat generation, fire, etc.



Seal the inlet hole for remote control cable with putty.

If dew, water, insect, etc. enters through the hole, it could cause electric shocks, fire or break-down.

If dew or water enters the unit, it may cause screen display anomalies.

When installing the unit at a hospital, telecommunication facility, etc., take measures to suppress electric noises.



It could cause malfunction or break-down due to hazardous effects on the inverter, private power generator, high frequency medical equipment, radio communication equipment, etc.

The influences transmitted from the remote control to medical or communication equipment could disrupt medical activities, video broadcasting or cause noise interference.



Do not leave the remote control with its upper case removed.

If dew, water, insect, etc. enters through the hole, it could cause electric shocks, fire or break-down.

 CAUTION

Do not install the remote control at following places.

- (1) It could cause break-down or deformation of remote control.
- Where it is exposed to direct sunlight
 - Where the ambient temperature becomes 0 °C or below, or 40 °C or above
 - Where the surface is not flat
 - Where the strength of installation area is insufficient
- (2) Moisture may be attached to internal parts of the remote control, resulting in a display failure.
- Place with high humidity where condensation occurs on the remote control
 - Where the remote control gets wet
- (3) Accurate room temperature may not be detected using the temperature sensor of the remote control.
- Where the average room temperature cannot be detected
 - Place near the equipment to generate heat
 - Place affected by outside air in opening/closing the door
 - Place exposed to direct sunlight or wind from air-conditioner
 - Where the difference between wall and room temperature is large



To connect to a personal computer via USB, use the dedicated software.**Do not connect other USB devices and the remote control at the same time.**

It could cause malfunction or break-down of the remote control/personal computer.

2) Accessories & Prepare on site

Following parts are provided.

Accessories	R/C main unit, wood screw (ø3.5 x 16) 2 pcs, Quick reference
-------------	--

Following parts are arranged at site. Prepare them according to the respective installation procedures.

Item name	Q'ty	Remark
Switch box For 1 piece or 2 pieces (JIS C 8340 or equivalent)	1	These are not required when installing directly on a wall.
Thin wall steel pipe for electric appliance directly on a wall. (JIS C 8305 or equivalent)	As required	
Lock nut, bushing (JIS C 8330 or equivalent)	As required	
Lacing (JIS C 8425 or equivalent)	As required	Necessary to run R/C cable on the wall.
Putty	Suitably	For sealing gaps
Molly anchor	As required	
R/C cable (0.3 mm ² x 2 pcs)	As required	See right table when longer than 100 m

When the cable length is longer than 100 m, the max size for wires used in the R/C case is 0.5 mm². Connect them to wires of larger size near the outside of R/C. When wires are connected, take measures to prevent water, etc. from entering inside.

≦ 200 m	0.5 mm ² x 2 cores
≦ 300m	0.75 mm ² x 2 cores
≦ 400m	1.25 mm ² x 2 cores
≦ 600m	2.0 mm ² x 2 cores

3) Installation place

Secure the installation space shown in the figure.

For the installation method, "embedding wiring" or "exposing wiring" can be selected.

For the wiring direction, "Backward", "Upper center" or "Upper left" can be selected.

Determine the installation place in consideration of the installation method and wiring direction.

Installation space

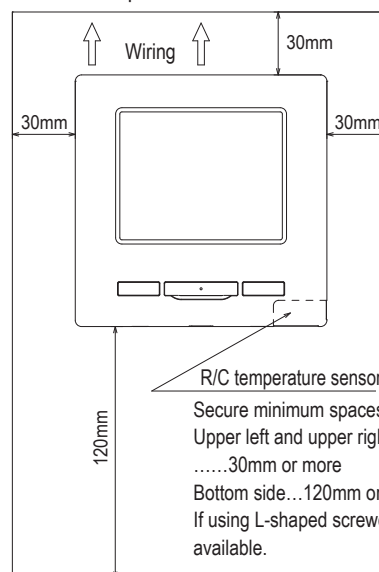

Secure minimum spaces for disassembling the case.
 Upper left and upper right sides
30mm or more
 Bottom side...120mm or more
 If using L-shaped screwdriver, 50mm or more is available.

4) Installation procedure

Perform installation and wiring work for the remote control according to the following procedure.

Dimensions (Viewed from front)

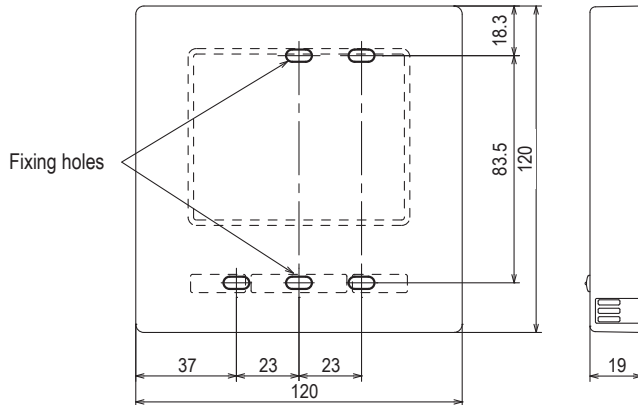

To disassemble the R/C case into the upper and lower pieces after assembling them once

- Insert the tip of flat head screwdriver or the like in the recess at the lower part of R/C and twist it lightly to remove. It is recommended that the tip of the screwdriver be wrapped with tape to avoid damaging the case.

Take care to protect the removed upper case from moisture or dust.

In case of embedding wiring

(When the wiring is retrieved "Backward")

① Embed the switch box and the R/C wires beforehand.

Seal the inlet hole for the R/C wiring with putty.

PCB side (Viewed from rear)

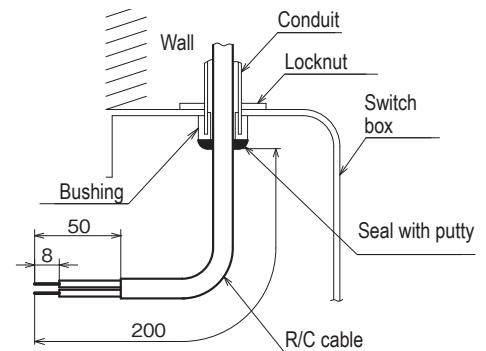
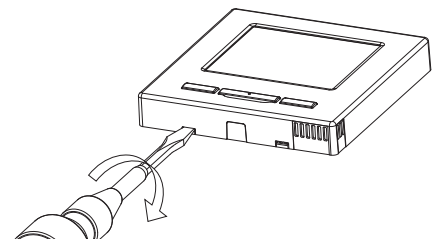
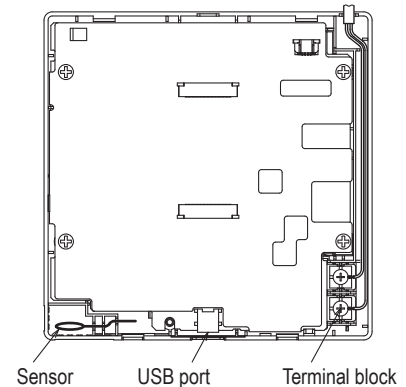

② When wires are passed through the bottom case, fix the bottom case at 2 places on the switch box.

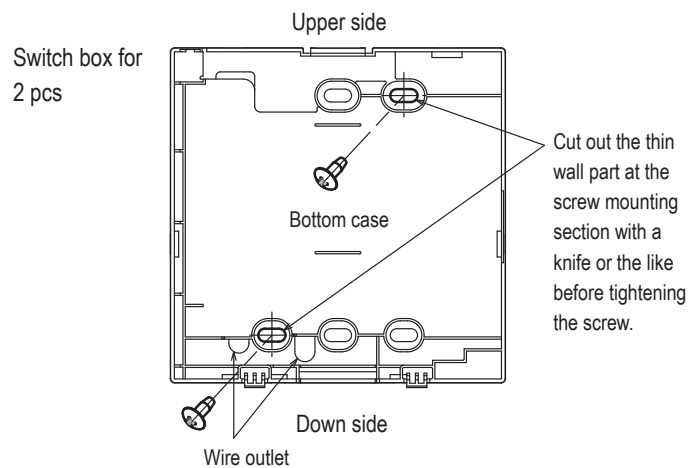
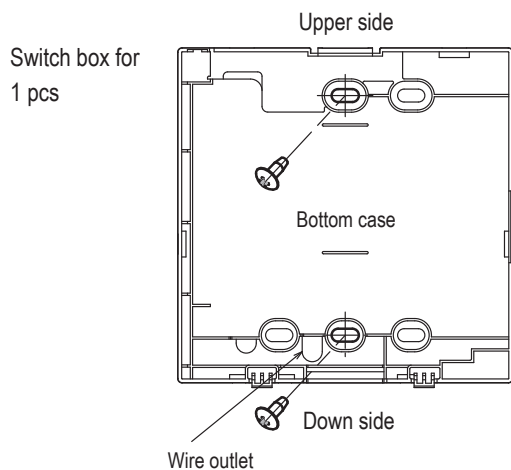

- ③ Connect wires from X and Y terminals of R/C to X and Y terminals of indoor unit. R/C wires (X, Y) have no polarity. Fix wires such that the wires will run around the terminal screws on the top case of R/C.
- ④ Install the upper case with care not to pinch wires of R/C.

Cautions for wire connection

Use wires of no larger than 0.5 mm² for wiring running through the remote control case. Take care not to pinch the sheath.

Tighten by hand (0.7 N·m or less) the wire connection. If the wire is connected using an electric driver, it may cause failure or deformation.

In case of exposing wiring

(When the wiring is taken out from the “upper center” or “upper left” of R/C)

- ① Cut out the thin wall sections on the cases for the size of wire.

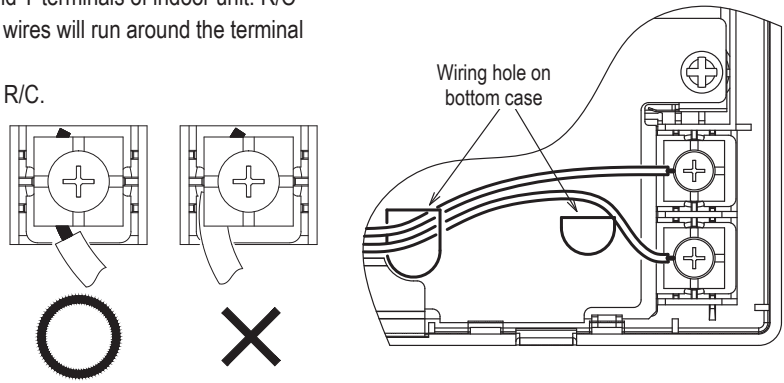

When taking the wiring out from the upper center, open a hole before separating the upper and bottom cases. This will reduce risk of damaging the PCB and facilitate subsequent work.
 When taking the wiring out from the upper left, take care not to damage the PCB and not to leave any chips of cut thin wall inside.

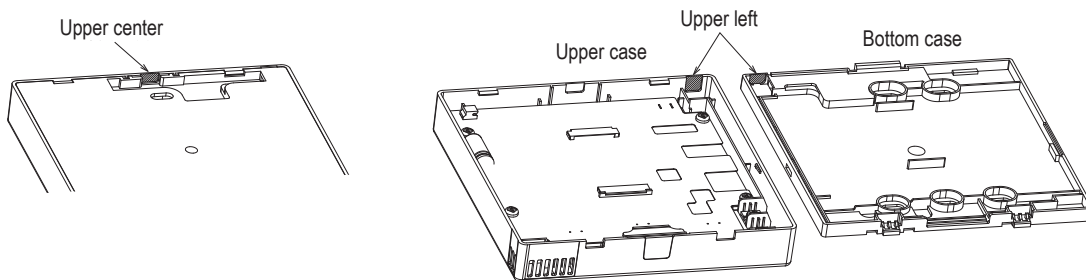

- ② Fix the bottom R/C case on a flat surface with two wood screws.
- ③ In case of the upper center, pass the wiring behind the bottom case. (Hatched section)
- ④ Connect wires from X and Y terminals of R/C to X and Y terminals of indoor unit. R/C wires (X, Y) have no polarity. Fix wires such that the wires will run around the terminal screws on the top case of R/C.
- ⑤ Install the top case with care not to pinch wires of R/C.
- ⑥ Seal the area cut in ① with putty.

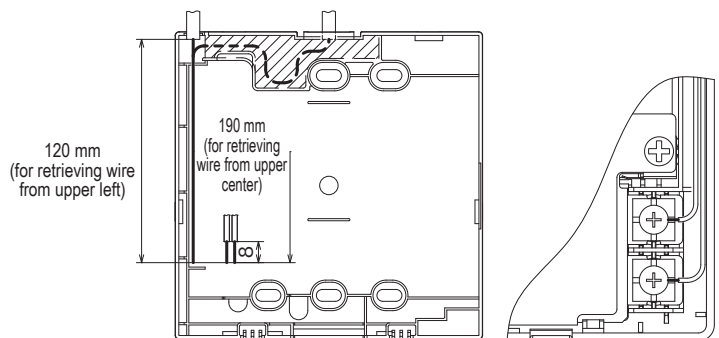

5) Main/Sub setting when more than one remote control are used

Up to two units of R/C can be used at the maximum for 1 indoor unit or 1 group.

One is main R/C and the other is sub R/C.

Operating range is different depending on the main or sub R/C.

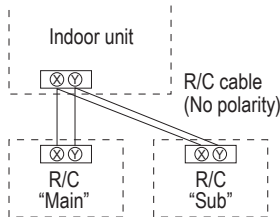

R/C operations		Main	Sub	
Run/Stop, Change set temp., Change flap direction, Auto swing, Change fan speed operations		○	○	
High power operation, Energy-saving operation		○	○	
Silent mode control		○	×	
Useful functions	Individual flap control	○	×	
	Anti draft setting	○	×	
	Timer	○	○	
	Favorite setting	○	○	
	Weekly timer	○	×	
	Home leave mode	○	×	
	External ventilation	○	○	
	Select the language	○	○	
	Silent mode control	○	×	
	Energy-saving setting		○	×
Filter	Filter sign reset	○	○	
User setting	Initial settings		○	○
	Administrator settings	Permission/Prohibition setting	○	×
		Outdoor unit silent mode timer	○	×
		Setting temp. range	○	×
	Temp increment setting	○	×	
	Set temp. display	○	○	
	R/C display setting	○	○	
Change administrator password	○	○		
F1/F2 function setting	○	○		

○ : operable × : not operable

R/C operations		Main	Sub			
Service setting	Installation settings	Installation date	○	×		
		Company information	○	○		
		Test run	○	×		
		Static pressure adjustment	○	×		
		Change auto-address	○	×		
		Address setting of main IU	○	×		
		IU back-up function	○	×		
		Motion sensor setting	○	×		
		R/C function settings	Main/Sub of R/C	○	○	
			Return air temp.	○	×	
			R/C sensor	○	×	
	R/C sensor adjustment		○	×		
	Operation mode		○	×		
	°C / °F		○	×		
	Fan speed		○	×		
	External input		○	×		
	Upper/lower flap control		○	×		
	Left/right flap control		○	×		
	Ventilation setting		○	×		
	Auto-restart		○	×		
	Auto temp. setting		○	×		
	Auto fan speed		○	×		
	IU settings		IU address		○	○
			Next service date		○	×
		Operation data		○	×	
		Error display	Error history	○	○	
			Display/erase anomaly data	○	×	
			Reset periodical check	○	○	
	Saving IU settings		○	×		
	Special settings	Erase IU address	○	×		
		CPU reset	○	○		
		Restore of default setting	○	×		
		Touch panel calibration	○	○		
	Indoor unit capacity display		○	×		

Advice: Connection to personal computer

It can be set from a personal computer via the USB port (mini-B). Connect after removing the cover for USB port of upper case. Replace the cover after use. Special software is necessary for the connection. For details, view the web site.

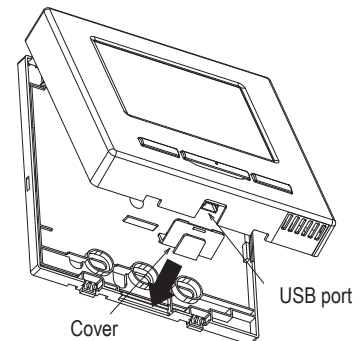

Advice: Initializing of password

Administrator password (for daily setting items) and service password (for installation, test run and maintenance) are used.

○ The administrator password at factory default is "0000". This setting can be changed (Refer to User's Manual).

If the administrator password is forgotten, it can be initialized by holding down the [F1] and [F2] switches together for five seconds on the administrator password input screen.

○ Service password is "9999", which cannot be changed.

When the administrator password is input, the service password is also accepted.

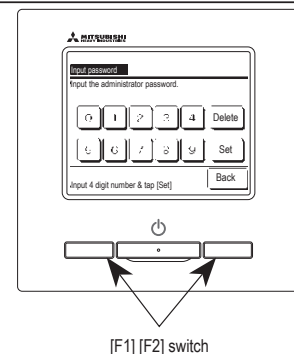

Advice



When connecting two or more FDT/FDTC to one R/C, unify the panel type either to a panel with anti draft function or a standard panel.

PJA012D730 

(2) Model RC-E5

Read together with indoor unit's installation manual.



⚠ WARNING

- Fasten the wiring to the terminal securely and hold the cable securely so as not to apply unexpected stress on the terminal.
Loose connection or hold will cause abnormal heat generation or fire. 
- Make sure the power source is turned off when electric wiring work.
Otherwise, electric shock, malfunction and improper running may occur. 

⚠ CAUTION

- Do not install the remote control at the following places in order to avoid malfunction.

(1) Places exposed to direct sunlight	(4) Hot surface or cold surface enough to generate condensation
(2) Places near heat devices	(5) Places exposed to oil mist or steam directly
(3) High humidity places	(6) Uneven surface

- Do not leave the remote control without the upper case.
In case the upper case needs to be detached, protect the remote control with a packaging box or bag in order to keep it away from water and dust. 

Accessories	Remote control, wood screw (ø3.5x16) 2 pieces
Prepare on site	Remote control cord (2 cores) the insulated thickness in 1mm or more. [In case of embedding cord] Electrical box, M4 screw (2 pieces) [In case of exposing cord] Cord clamp (if needed)

Installation procedure

- ① Open the cover of remote control, and remove the screw under the buttons without fail.
- ② Remove the upper case of remote control.
Insert a flat-blade screwdriver into the dented part of the upper part of the remote control, and wrench slightly.

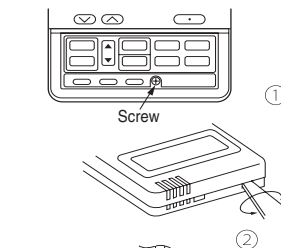

[In case of embedding cord]

- ③ Embed the electrical box and remote control cord beforehand.

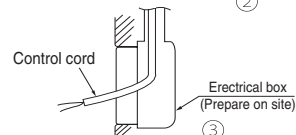

- ④ Prepare two M4 screws (recommended length is 12-16mm) on site, and install the lower case to electrical box. Choose either of the following two positions in fixing it with screws.

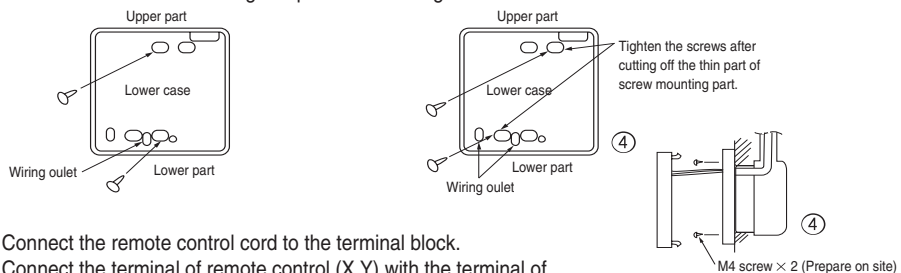

- ⑤ Connect the remote control cord to the terminal block.
Connect the terminal of remote control (X,Y) with the terminal of indoor unit (X,Y). (X and Y are no polarity)
- ⑥ Install the upper case as before so as not to catch up the remote control cord, and tighten with the screws.

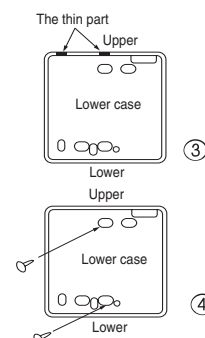

[In case of exposing cord]

- ③ You can pull out the remote control cord from left upper part or center upper part.
Cut off the upper thin part of remote control lower case with a nipper or knife, and grind burrs with a file etc.
- ④ Install the lower case to the flat wall with attached two wooden screws.

- ⑤ Connect the remote control cord to the terminal block.
Connect the terminal of remote control (X,Y) with the terminal of indoor unit (X,Y).
(X and Y are no polarity)
Wiring route is as shown in the right diagram depending on the pulling out direction.

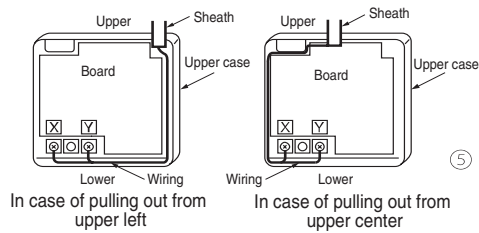

The wiring inside the remote control case should be within 0.3mm² (recommended) to 0.5mm².
The sheath should be peeled off inside the remote control case.
The peeling-off length of each wire is as below.

Pulling out from upper left	Pulling out from upper center
X wiring : 215mm	X wiring : 170mm
Y wiring : 195mm	Y wiring : 190mm

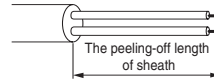

- ⑥ Install the upper case as before so as not to catch up the remote control cord, and tighten with the screws.
- ⑦ In case of exposing cord, fix the cord on the wall with cord clamp so as not to slack.

Installation and wiring of remote control

- ① Wiring of remote control should use 0.3mm² × 2 cores wires or cables. (on-site configuration)
 - ② Maximum prolongation of remote control wiring is 600 m.
If the prolongation is over 100m, change to the size below.
But, wiring in the remote control case should be under 0.5mm². Change the wire size outside of the case according to wire connecting. Waterproof treatment is necessary at the wire connecting section. Be careful about contact failure.
- 100 - 200m.....0.5mm² × 2 cores
Under 300m.....0.75mm² × 2 cores
Under 400m.....1.25mm² × 2 cores
Under 500m.....2.0mm² × 2 cores

Master/ slave setting when more than one remote controls are used

A maximum of two remote controls can be connected to one indoor unit (or one group of indoor units.)

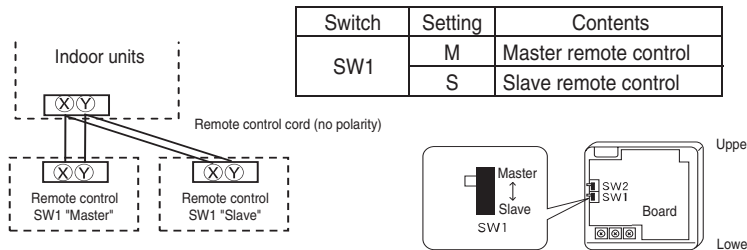

Set SW1 to "Slave" for the slave remote control. It was factory set to "Master" for shipment.
Note: The setting "Remote control sensor enabled" is only selectable with the master remote control in the position where you want to check room temperature.
The air-conditioner operation follows the last operation of the remote control regardless of the master/ slave setting of it.

The indication when power source is supplied

When power source is turned on, the following is displayed on the remote control until the communication between the remote control and indoor unit settled.

Master remote control : " WAIT M"
Slave remote control : " WAIT S"

At the same time, a mark or a number will be displayed for two seconds first.
This is the software's administration number of the remote control, not an error cord.

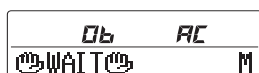

※ The left mark is only an example. Other marks may appear.

When remote control cannot communicate with the indoor unit for half an hour, the below indication will appear.
Check wiring of the indoor unit and the outdoor unit etc.



The range of temperature setting

When shipped, the range of set temperature differs depending on the operation mode as below.

Heating : 16-30°C (55-86°F)

Except heating (cooling, fan, dry, automatic) : 18-30°C (62-86°F)

● **Upper limit and lower limit of set temperature can be changed with remote control.**

Upper limit setting: valid during heating operation. Possible to set in the range of 20 to 30°C (68 to 86°F).

Lower limit setting: valid except heating (automatic, cooling, fan, dry) Possible to set in the range of 18 to 26°C (62 to 79°F).

When you set upper and lower limit by this function, control as below.

1. When ⑫ TEMP RANGE SET, remote control function of function setting mode is "INDN CHANGE" (factory setting),
 [If upper limit value is set]

During heating, you cannot set the value exceeding the upper limit.

- [If lower limit value is set]

During operation mode except heating, you cannot set the value below the lower limit.

2. When ⑫ TEMP RANGE SET, remote control function of function setting mode is "NO INDN CHANGE"

- [If upper limit value is set]

During heating, even if the value exceeding the upper limit is set, upper limit value will be sent to the indoor unit.

But, the indication is the same as the temperature set.

- [If lower limit value is set]

During except heating, even if the value lower than the lower limit is set, lower limit value will be sent to the indoor unit.

But, the indication is the same as the temperature set.

● **How to set upper and lower limit value**

1. Stop the air-conditioner, and press (SET) and (MODE) button at the same time for over three seconds .

The indication changes to "FUNCTION SET ▼".

2. Press button once, and change to the "TEMP RANGE ▲" indication.

3. Press (SET) button, and enter the temperature range setting mode.

4. Select "UPPER LIMIT ▼" or "LOWER LIMIT ▲" by using button.

5. Press (SET) button to fix.

6. When "UPPER LIMIT ▼" is selected (valid during heating)

① Indication: " ▼ ^ SET UP " → "UPPER 30°C ▼"

② Select the upper limit value with temperature setting button . Indication example: "UPPER 26°C ▼ ^" (blinking)

③ Press (SET) button to fix. Indication example: "UPPER 26°C" (Displayed for two seconds)

After the fixed upper limit value displayed for two seconds, the indication will return to "UPPER LIMIT ▼".

7. When "LOWER LIMIT ▲" is selected (valid during cooling, dry, fan, automatic)

① Indication: " ▼ ^ SET UP " → "LOWER 18°C ^"

② Select the lower limit value with temperature setting button . Indication example: "LOWER 24°C ▼ ^" (blinking)

③ Press (SET) button to fix. Indication for example: "LOWER 24°C" (Displayed for two seconds)

After the fixed lower limit value displayed for two seconds, the indication will return to "LOWER LIMIT ▼".

8. Press button to finish.

• It is possible to finish by pressing button on the way, but unfinished change of setting is unavailable.

• During setting, if you press (RESET) button, you return to the previous screen.

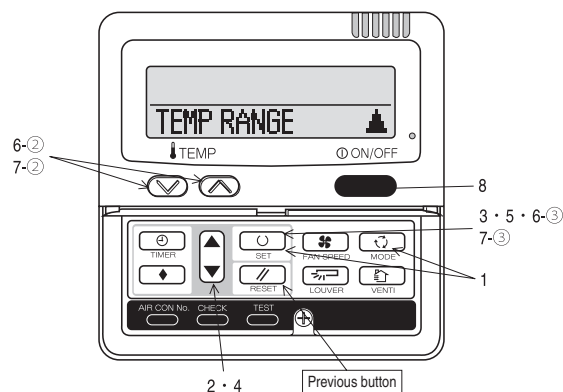

The functional setting

● The initial function setting for typical using is performed automatically by the indoor unit connected, when remote control and indoor unit are connected.
 As long as they are used in a typical manner, there will be no need to change the initial settings.
 If you would like to change the initial setting marked "○", set your desired setting as for the selected item.
 The procedure of functional setting is shown as the following diagram.

[Flow of function setting]

Start : Stop air-conditioner and press "○" (SET) and "⏏" (MODE) buttons at the same time for over three seconds.
 Finalize : Press "○" (SET) button.
 Reset : Press "⏏" (RESET) button.
 Select : Press "▲" (UP) button.
 End : Press "⏏" (OFF) button.
 It is possible to finish above setting on the way, and unfinished change of setting is unavailable.
 * ○ : Initial settings
 * ※ : Automatic criterion

Record and keep the setting

Consult the technical data etc. for each control details

Stop air-conditioner and press "○" (SET) + "⏏" (MODE) buttons at the same time for over three seconds.

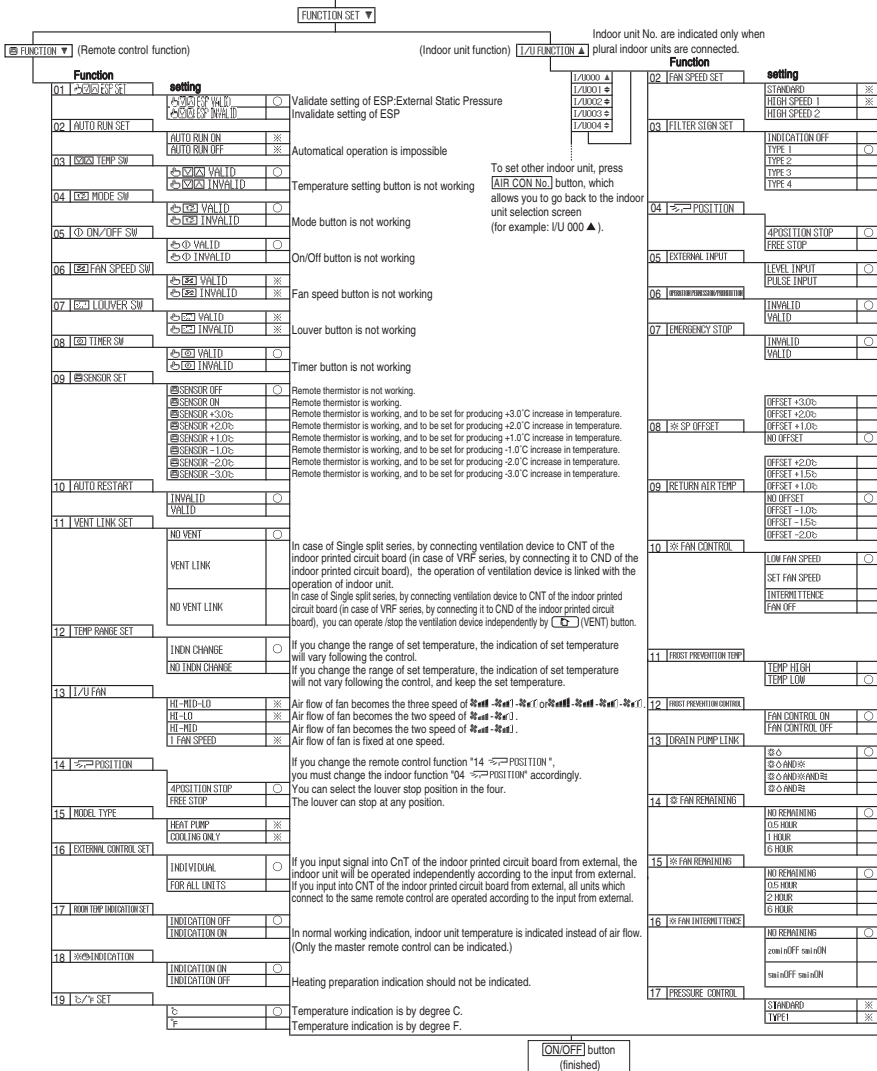

Note 1: The initial setting marked "※" is decided by connected indoor and outdoor unit, and is automatically defined as following table.

Function No.	Item	Default	Model
Remote control function02	AUTO RUN SET	AUTO RUN ON	"Auto-RUN" mode selectable indoor unit.
	AUTO RUN OFF	AUTO RUN OFF	Indoor unit without "Auto-RUN" mode
Remote control function06	FAN SPEED SW	VALID	Indoor unit with two or three step of air flow setting
		INVALID	Indoor unit with only one of air flow setting
Remote control function07	LOUVER SW	VALID	Indoor unit with automatically swing louver
		INVALID	Indoor unit without automatically swing louver
Remote control function13	I/U FAN	HI-MID-LO	Indoor unit with three step of air flow setting
		HI-LO	Indoor unit with two step of air flow setting
		HI-MID	Indoor unit with only one of air flow setting
Remote control function15	MODEL TYPE	HEAT PUMP	Heat pump unit
		COOLING ONLY	Exclusive cooling unit

Note 3: As for plural indoor unit, set indoor functions to each master and slave indoor unit.
 But only master indoor unit is received the setting change of indoor unit function "05 EXTERNAL INPUT" and "06 PERMISSION / PROHIBITION".

Note2: Fan setting of "HIGH SPEED"

Fan tap	Indoor unit air flow setting			
	Hi-Lo	Hi-Me	Lo-Me	Hi-Me
FAN SPEED SET	STANDARD	UH - Hi - Me - Lo	Hi - Me - Lo	Hi - Lo
HIGH SPEED1, 2	UH - UH - Hi - Me	UH - Hi - Me	UH - Me	UH - Hi

[Initial function setting of some indoor unit is "HIGH SPEED".]

The filter sign is indicated after running for 180 hours.
 The filter sign is indicated after running for 600 hours.
 The filter sign is indicated after running for 1000 hours.
 The filter sign is indicated after running for 1000 hours, then the indoor unit will be stopped by computation after 24 hours.

If you change the indoor function "04 POSITION", you must change the remote control function "14 POSITION" accordingly.
 You can select the lower stop position in the four.
 The louver can stop at any position.

Permission/prohibition control of operation will be valid.

With the VRF series, it is used to stop all indoor units connected with the same outdoor unit immediately.
 When stop signal is inputted from remote on-off terminal "CNT-6", all indoor units are stopped immediately.

To be reset for producing +3.0C increase in temperature during heating.
 To be reset for producing +2.0C increase in temperature during heating.
 To be reset for producing +1.0C increase in temperature during heating.

To be reset producing +2.0C increase in return air temperature of indoor unit.
 To be reset producing +1.5C increase in return air temperature of indoor unit.
 To be reset producing +1.0C increase in return air temperature of indoor unit.

To be reset producing -1.0C increase in return air temperature of indoor unit.
 To be reset producing -1.5C increase in return air temperature of indoor unit.
 To be reset producing -2.0C increase in return air temperature of indoor unit.

When heating thermostat is OFF, fan speed is low speed.
 When heating thermostat is OFF, fan speed is set speed.

When heating thermostat is OFF, fan speed is operated intermittently.
 When heating thermostat is OFF, the fan is stopped.
 When the remote thermostat is working, "FAN OFF" is set automatically.
 Do not set "FAN OFF" when the indoor unit's thermostat is working.

Change of indoor heat exchanger temperature to start frost prevention control.

Working only with the Single split series.
 To control frost prevention, the indoor fan tap is raised.

Drain pump is run during cooling and dry.
 Drain pump is run during cooling, dry and heating.
 Drain pump is run during cooling, dry, heating and fan.
 Drain pump is run during cooling, dry and fan.

After cooling is stopped is OFF, the fan does not perform extra operation.
 After cooling is stopped is OFF, the fan perform extra operation for half an hour.
 After cooling is stopped is OFF, the fan perform extra operation for an hour.
 After cooling is stopped is OFF, the fan perform extra operation for two hours.
 After cooling is stopped is OFF, the fan perform extra operation for six hours.

After heating is stopped or heating thermostat is OFF, the fan does not perform extra operation.
 After heating is stopped or heating thermostat is OFF, the fan perform extra operation for half an hour.
 After heating is stopped or heating thermostat is OFF, the fan perform extra operation for two hours.
 After heating is stopped or heating thermostat is OFF, the fan perform extra operation for six hours.

During heating is stopped or heating thermostat is OFF, the fan perform intermittent operation for five minutes with low fan speed after twenty minutes OFF.
 During heating is stopped or heating thermostat is OFF, the fan perform intermittent operation for five minutes with low fan speed after five minutes' OFF.

Connected "OA Processing" type indoor unit, and is automatically defined.

How to set function

1. Stop air-conditioner and press (SET) (MODE) buttons at the same time for over three seconds, and the "FUNCTION SET ▼" will be displayed.



2. Press (SET) button.
3. Make sure which do you want to set, "FUNCTION ▼" (remote control function) or "I/U FUNCTION ▲" (indoor unit function).
4. Press or button.
Select "FUNCTION ▼" (remote control function) or "I/U FUNCTION ▲" (indoor unit function).

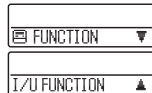

5. Press (SET) button.

6. 【On the occasion of remote control function selection】

- ① "DATA LOADING" (Indication with blinking)

↓
Display is changed to "01 ESP SET".

- ② Press or button.
"No. and function" are indicated by turns on the remote control function table, then you can select from them.
(For example)

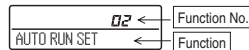

- ③ Press (SET) button.
The current setting of selected function is indicated.
(for example) "AUTO RUN ON" ← If "02 AUTO RUN SET" is selected

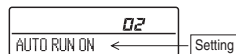

- ④ Press or button.
Select the setting.

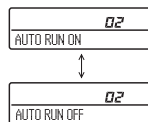

- ⑤ Press (SET)
"SET COMPLETE" will be indicated, and the setting will be completed.
Then after "No. and function" indication returns, Set as the same procedure if you want to set continuously, and if to finish, go to 7.



7. Press (ON/OFF) button.
Setting is finished.

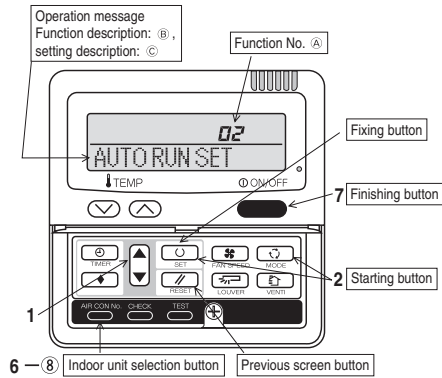

【On the occasion of indoor unit function selection】

- ① "DATA LOADING" (Blinking for 2 to 23 seconds to read the data)

↓
Indication is changed to "02 FAN SPEED SET".
Go to ②.

【Note】

- (1) If plural indoor units are connected to a remote control, the indication is "I/U 000" (blinking) ← The lowest number of the indoor unit connected is indicated.

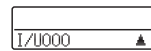

- (2) Press or button.
Select the number of the indoor unit you are to set
If you select "ALL UNIT ▼", you can set the same setting with all unites.
- (3) Press (SET) button.

- ② Press or button.
"No. and function" are indicated by turns on the indoor unit function table, then you can select from them.
(For example)

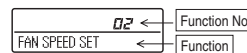

- ③ Press (SET) button.
The current setting of selected function is indicated.
(For example) "STANDARD" ← If "02 FAN SPEED SET" is selected.

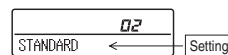

- ④ Press or button.
Select the setting.

- ⑤ Press (SET) button.
"SET COMPLETE" will be indicated, and the setting will be completed.
Then after "No. and function" indication returns, set as the same procedure if you want to set continuously, and if to finish, go to 7.



※ When plural indoor units are connected to a remote control, press the (AIR CON No.) button, which allows you to go back to the indoor unit selection screen. (example "I/U 000 ▲")

- It is possible to finish by pressing (ON/OFF) button on the way, but unfinished change of setting is unavailable.
- During setting, if you press (RESET) button, you return to the previous screen.
- Setting is memorized in the control and it is saved independently of power failure.

【How to check the current setting】

When you select from "No. and function" and press set button by the previous operation, the "Setting" displayed first is the current setting.
(But, if you select "ALL UNIT ▼", the setting of the lowest number indoor unit is displayed.)

1.10.4 Installation of outdoor unit

Model FDC71VNX-W

PSC012D127A
Inverter driven split PAC
71VNX-W
Designed for R32 refrigerant

Ⓞ This installation manual deals with outdoor units and general installation specifications only. For indoor units, refer to the respective installation manuals supplied with the units.
 Ⓞ When install the unit, be sure to check whether the selection of installation place, power source specifications, usage limitation (piping length, height differences between indoor and outdoor units, power source voltage and etc.) and installation spaces.

SAFETY PRECAUTIONS

- We recommend you to read this "SAFETY PRECAUTIONS" carefully before the installation work in order to gain full advantage of the functions of the unit and to avoid malfunction due to mishandling.
- The precautions described below are divided into **WARNING** and **CAUTION**. The matters with possibilities leading to serious consequences such as death or serious personal injury due to erroneous handling are listed in the **WARNING**, and the matters with possibilities leading to personal injury or damage of the unit due to erroneous handling including probability leading to serious consequences in some cases are listed in **CAUTION**. **These are very important precautions for safety. Be sure to observe all of them without fail.**
- The meaning of "Marks" used here are as shown below.

	Never do it under any circumstance.
	Always do it according to the instruction
- Units of single phase power source are equipment complying with IEC61000-3-12.
- Be sure to confirm no anomaly on the equipment by commissioning after completed installation and explain the operating methods as well as the maintenance methods of this equipment to the user according to the owner's manual.
- Keep the installation manual together with owner's manual at a place where any user can read at any time. Moreover if necessary, ask to hand them to a new user.

Check before installation work

- Model name and power source
- Refrigerant piping length
- Piping, wiring and miscellaneous small parts
- Indoor unit installation manual

	WARNING
<p> Installation must be carried out by the qualified installer. If you install the system by yourself, it may cause serious trouble such as water leaks, electric shocks, fire and personal injury, as a result of a system malfunction.</p> <p> Install the system in full accordance with the instruction manual! Incorrect installation may cause burns, personal injury, water leaks, electric shocks and fire.</p> <p> Use the correct pipe and correct components for installation. If parts other than those prescribed in the instruction manual are used, it may cause fall of the unit, water leaks, electric shocks, fire, refrigerant leak, substantial performance, control failure and personal injury.</p> <p> When installing in small rooms, take prevention measures not to exceed the density limit of refrigerant in the event of leakage Consult the expert about prevention measures. If the density of refrigerant exceeds the limit in the event of leakage, lack of oxygen can occur, which can cause serious accidents.</p> <p> Ventilate the working area well in the event of refrigerant leakage during installation. If the refrigerant comes into contact with naked flames, poisonous gas is produced.</p> <p> After completed installation, check that no refrigerant leaks from the system. If there are any leaks, stop the work immediately and contact the dealer.</p> <p> Use the unit at the specified location with pipes which can support the weight in lifting for portage. And to avoid jolting out of alignment, be sure to hang up the unit at 4-point support. An improper manner of portage such as 2-point support can cause death or serious personal injury due to falling of the unit.</p> <p> Install the unit in a location with good support. Unsuitable installation locations can cause the unit to fall and cause material damage and personal injury.</p> <p> Ensure the unit is stable when installed, so that it can withstand earthquakes and strong winds. Unsuitable installation locations can cause the unit to fall and cause material damage and personal injury.</p> <p> The electrical installation must be carried out by the qualified electrician in accordance with "the norm for electrical work" and "national wiring regulation", and the system must be connected to the dedicated circuit. Power source with insufficient capacity and incorrect function done by improper work can cause electric shocks and fire.</p> <p> Be sure to shut off the power before starting electrical work. Failure to shut off the power can cause electric shocks, unit failure or incorrect function of equipment.</p> <p> Be sure to use the cables conformed to safety standard and cable ampacity for power distribution work. Unconformable cables can cause electric leak, anomalous heat production or fire.</p> <p> Use the prescribed cables for electrical connection, tighten the cables securely in terminal block and relieve the cables correctly to prevent Loose connections or cable mountings can cause anomalous heat production or fire.</p> <p> Arrange the wiring in the control box so that it cannot be pushed up further into the box. Install the service panel correctly. Incorrect installation may result in overheating and fire.</p> <p> Do not perform brazing work in the airtight room It can cause lack of oxygen.</p> <p> Use the prescribed pipes, flare nuts and tools for R32 and R410A. Using existing parts (for R22 or R407C) can cause the unit failure and serious accidents due to burst of the refrigerant circuit.</p>	<p> Tighten the flare nut by using double spanners and torque wrench according to prescribed method. Be sure not to tighten the flare nut too much. Over-tightening on the flare part by tightening with excess torque can cause burst or refrigerant leaks which may result in lack of oxygen.</p> <p> Do not open the service valves for liquid line and gas line until completed refrigerant piping work, air tightness test and evacuation. If the compressor is operated in state of opening service valves before completed connection of refrigerant piping work, you may incur frost bite or injury from an abrupt refrigerant outflow and air can be sucked into refrigerant circuit, which can cause burst or personal injury due to anomalously high pressure in the refrigerant.</p> <p> Only use prescribed optional parts. The installation must be carried out by the qualified installer. If you install the system by yourself, it can cause serious trouble such as water leaks, electric shocks, fire.</p> <p> Do not perform any change of protective device itself or its setup condition Ineffective device of pressure switch and temperature control or the use of non specified component can cause fire or burst.</p> <p> Be sure to switch off the power source in the event of installation, inspection or servicing. If the power source is not shut off, there is a risk of electric shocks, unit failure or personal injury due to the unexpected start of fan.</p> <p> Consult the dealer or an expert regarding removal of the unit. Incorrect installation can cause water leaks, electric shocks or fire.</p> <p> Stop the compressor before closing valve and disconnecting refrigerant pipes in case of pump down operation. If disconnecting refrigerant pipes in state of opening service valves before compressor stopping, you may incur frost bite or injury from an abrupt refrigerant outflow and air can be sucked, which can cause burst or personal injury due to anomalously high pressure in the refrigerant circuit.</p> <p> Be sure to wear protective goggles and gloves while at work.</p> <p> This unit is designed specifically for R32. Using any other refrigerant can cause unit failure and personal injury.</p> <p> Ensure that no air enters in the refrigerant circuit when the unit is installed and removed. If air enters in the refrigerant circuit, the pressure in the refrigerant circuit becomes too high, which can cause burst and personal injury.</p> <p> Do not touch the unit with removed panels or protrusions Touching rotating equipments, hot surfaces or high voltage parts can cause personal injury due to entrapment, burn or electric shocks.</p> <p> Be sure to fix up the service panels. Incorrect fixing can cause electric shocks or fire due to intrusion of dust or water.</p> <p> Do not perform any repairs or modifications by yourself. Consult the dealer if the unit requires repair. If you repair or modify the unit, it can cause water leaks, electric shocks or fire.</p> <p> Do not process or splice the power cord, or share the socket with other power plugs. This may cause fire or electric shock due to deflecting contact, deflecting insulation and over-current etc.</p> <p> Do not bundle or wind or process the power cord. Do not deform the power cord by treading it. This may cause fire or heating.</p>

CAUTION

Do not use the base frame for outdoor unit which is corroded or damaged due to long periods of operation.
Using an old and damaged base frame can cause the unit falling down and cause personal injury.

Do not install the unit in the locations listed below

- Locations where carbon fiber, metal powder or any powder is floating.
- Locations where any substances that can affect the unit such as sulphide gas, chloride gas, acid and alkaline can occur.
- Venues and ships
- Locations where any flammable or special sprays are often used.
- Locations with direct exposure of oil mist and steam such as kitchen and machine plant.
- Locations where any machines which generate high frequency harmonics are used.
- Locations with salty atmospheres such as coastlines
- Locations with heavy snow if installed, be sure to provide base frame and snow hood mentioned in the manual
- Locations at high altitude (more than 1 000m by snow)
- Locations with ammoniac atmospheres (e.g. organic fertilizer)
- Locations with calcium chloride (e.g. snow melting agent)
- Locations where heat radiation from other heat sources can affect the unit
- Locations where vibration can be amplified and transmitted due to insufficient strength of structure.
- Locations where vibration and operation sound generated by the outdoor unit can affect seriously, (on the wall or at the place near bed room)
- Locations where an equipment affected by high harmonics is placed, (TV set or radio receiver is placed within 5m)
- Locations where drainage cannot run or safely.
- Locations where air affect surrounding environment and causes a drain.

Do not use the unit for special purposes such as storing foods, coding precision instruments and preservation of animals, plants or art.
It can cause remarkable decrease in performance, corrosion and damage of components, malfunction and fire.

Do not install the outdoor unit in the locations listed below.

- Locations where asperger hot air or operating sound of the outdoor unit can bother neighborhood.
- Locations where vibration can be amplified and transmitted due to insufficient strength of structure.
- Locations where vibration and operation sound generated by the outdoor unit can affect seriously, (on the wall or at the place near bed room)
- Locations where an equipment affected by high harmonics is placed, (TV set or radio receiver is placed within 5m)
- Locations where drainage cannot run or safely.
- Locations where air affect surrounding environment and causes a drain.

Do not use the unit for special purposes such as storing foods, coding precision instruments and preservation of animals, plants or art.
It can cause remarkable decrease in performance, corrosion and damage of components, malfunction and fire.

Do not touch any refrigerant pipes with wet hands
It can cause electric shocks.

Do not touch any refrigerant pipes with your hands when the system is in operation.
During operation the refrigerant pipes become extremely hot or extremely cold depending on the operating condition, and it can cause burn injury or frost injury.

Do not clean up the unit with wet water
It can cause electric shocks.

Do not operate the outdoor unit with any article placed on it.
You may incur property damage or personal injury from a fall of the article.

Do not step onto the outdoor unit.
You may incur injury from a drop of fall.

Do not touch the suction or aluminum fin on the outdoor unit.
This may cause injury.

CAUTION

Carry out the electrical work for ground lead with care
Do not connect the ground lead to the gas line, water line, lightning conductor, or telephone line's ground lead. Incorrect grounding can cause unit faults such as electric shocks due to short-circuiting. Never connect the grounding wire to a gas pipe because if gas leaks it could cause explosion or fire.

Use the circuit breaker for all jobs with correct capacity.
Using the incorrect circuit breaker, it can cause the unit malfunction and fire.

Install isolator or disconnect switch on the power source wiring in accordance with the local codes and regulations.
The isolator should be located in accordance with E1621204-1.

Take care when carrying the unit by hand.
The unit is heavy and should be carried by two or more persons. Do not carry by the plastic straps, always use the carry handle when carrying the unit by hand. Use the correct lifting technique to minimize the risk of falls by the aluminum fins.

Dispose of any packing materials correctly.
Any remaining packing materials can cause personal injury as it contains nails and wood. And to avoid danger of suffocation, be sure to keep the plastic wrapper away from children and to dispose after tear it up.

Pay attention not to damage the drain pan by weld spatter when welding work is done near the indoor unit.
If weld spatter entered into the indoor unit during welding work, it can cause pin-hole in drain pan and result in water leakage. To prevent such damage, keep the indoor unit in its packing or cover it.

Be sure to insulate the refrigerant pipes so as not to condense the ambient air moisture on them.
Insufficient insulation can cause condensation, which can lead to moisture damage on the ceiling, floor, furniture and any other variables.

Be sure to perform air tightness test by pressurizing with nitrogen gas after completed refrigerant piping work.
If the density of refrigerant exceeds the limit in the event of refrigerant leakage in the small room, lack of oxygen can occur, which can cause serious accidents.

From the start of work, pay attention to the necessary safety measures.
If safety facilities are not provided, it can cause personal injury due to falling from the installation place.

After maintenance, all wiring, wiring ties and the like, should be returned to their original state and wiring route, and the necessary clearance from all metal parts should be secured.

Earth leakage breaker must be installed
If the earth leakage breaker is not installed, it can cause fire or electric shocks.

Do not use any materials other than a fuse with the correct rating in the location where fuses are to be used.
Connecting the circuit with copper wire or other metal thread can cause unit failure and fire.

Do not install the unit near the location where leakage of combustible gases can occur.
If leaked gases accumulate around the unit, it can cause fire.

Do not install the unit where corrosive gas (such as sulfuric acid gas etc.) or combustible gas (such as thinner and petroleum gases) can condense or collect or where water or steam is accumulated.
Corrosive or combustible gas can cause unit failure and fire. And combustible gas can cause fire.

Secure a space for installation, inspection and maintenance specified in the manual.
Insufficient space can result in accident such as personal injury due to falling from the installation place.

When the outdoor unit is installed on a roof or a high place, provide permanent ladders and handrails along the access route and handrails around the outdoor unit.
If safety facilities are not provided, it can cause personal injury due to falling from the installation place.

Do not install nor use the system close to the equipment that generates electromagnetic fields or high frequency harmonics
Equipment such as inverters, standby generators, medical high frequency equipments and telecommunication equipments can affect the system, and cause malfunctions and breakdowns. The system can also affect medical equipment and telecommunication equipment, and destruct its function or cause jamming.

Do not install the outdoor unit in a location where insects and small animals can inhabit.
Insects and small animals can enter the electric parts and cause damage of fire. Instruct the user to keep the surroundings clean.

Notabilia as a unit designed for R410A

- Do not use any refrigerant other than R32. R32 will rise to pressure about 1.6 times higher than that of a conventional refrigerant (R22 or R407C).
- A cylinder containing R32 has a light blue indication mark on the top.
- The processed dimension of the flared part of a refrigerant pipe and a flare nut's parallel side measurement have also been altered to raise strength against pressure. Accordingly, you are required to arrange dedicated R32 tools listed in the table on the right before installing or servicing this unit.
- Do not use a charge cylinder. The use of a charge cylinder will cause the refrigerant composition to change, which results in performance degradation.
- In charging refrigerant, always take it out from a cylinder in the liquid phase.
- All indoor units must be models designed exclusively for R32. Check connectable indoor unit models in a catalog, etc. (A wrong indoor unit, if connected into the system, will impair proper system operation.)

a)	Gauge manifold	Dedicated R32 and R410A tools
b)	Charge hose	
c)	Electronic scale for refrigerant charging	
d)	Torque wrench	
e)	Flare tool	
f)	Protrusion control copper pipe gauge	
g)	Vacuum pump adapter	
h)	Gas leak detector	

1. HAULAGE AND INSTALLATION (Take particular care in carrying in or moving the unit, and always perform such an operation with two or more persons.)

CAUTION

When a unit is hoisted with slings for haulage, take into consideration the offset of its gravity center position. If not properly balanced, the unit can be thrown off-balance and fall.

1) Delivery

- Deliver the unit as close as possible to the installation site before removing it from the packaging.
- When some compelling reason necessitates the unpacking of the unit before it is carried in, use nylon slings or protective wood pieces so as not to damage the unit by ropes lifting it.

Pad
Wooden pallet

2) Portage

- The right hand side of the unit as viewed from the front (diffuser side) is heavier. A person carrying the right hand side must take heed of this fact. A person carrying the left hand side must hold with his right hand the handle provided on the front panel of the unit and with his left hand the corner column section.

Heavy

2) Determination of pipe size

● Determine refrigerant pipe size pursuant to the following guidelines based on the indoor unit specifications.

	Model 71V	
	Gas pipe	Liquid pipe
Outdoor unit connected	φ15.88	φ9.52
	Flare	Flare
Refrigerant piping (Main pipe L)	φ15.88	φ9.52
	φ15.88	φ9.52
In the case a single type	Model 71V	
Capacity of indoor unit	DIS-WA1	
Branching pipe set	φ12.7	φ9.52
Refrigerant piping (branch pipe L1 L2)	φ12.7	φ9.52
In the case a twin type	φ12.7	φ6.35
Capacity of indoor unit	Model 40V x2	

▲ **CAUTION** ● When the 40V model is connected as an indoor unit, always use a φ9.52 liquid pipe for the branch (branching pipe – indoor unit) and a different diameter joint supplied with the branching pipe set for connection with the indoor unit (φ6.35 on the liquid pipe side).

- If a φ6.35 pipe is used for connection with a branching pipe, a refrigerant distribution disorder may occur, causing one of the indoor units to fall short of the rated capacity.
- A riser pipe must be a part of the main. A branching pipe set should be installed horizontally at a point as close to an indoor unit as possible.
- A branching part must be dressed with a heat-insulation material supplied as an accessory.
- For the details of installation work required at and near a branching area, see the installation manual supplied with your branching pipe set.

3) Refrigerant pipe wall thickness and material

● Select refrigerant pipes of the table shown on the right wall thickness and material as specified for each pipe size.

Pipe diameter [mm]	6.35	9.52	12.7	15.88
Minimum pipe wall thickness [mm]	0.8	0.8	0.8	1.0
Pipe material*	O-type pipe	O-type pipe	O-type pipe	O-type pipe

● Select pipes having a wall thickness larger than the specified minimum pipe thickness.

*Phosphorus deoxidized seamless copper pipe C1220T, JIS H3300

4) On-site piping work

▲ **IMPORTANT** ● Take care so that installed pipes may not touch components within a unit. If touching with an internal component, it will generate abnormal sounds and/or vibrations.

● Please remove the screw of a side cover and remove to the front.

- Carry out the on site piping work with the service valve fully closed.
- Give sufficient protection to a pipe end (compressed and blazed, or with an adhesive tape) so that water or foreign matters may not enter the piping.
- Bend a pipe to a radius as large as practical (R100 – R150). Do not bend a pipe repeatedly to correct its form.
- Flare connection is used between the unit and refrigerant pipe. Flare a pipe after engaging a flare nut onto it. Flare dimensions for R32 are different from those for conventional R22 and R407C. Although we recommend the use of flaring tools designed specifically for R32, conventional flaring tools can also be used by adjusting the measurement of protrusion B with a protrusion control gauge.
- The pipe should be anchored every 1.5m or less to isolate the vibration.
- Tighten a flare joint securely with a double spanner.

▲ **CAUTION**

Do not apply force beyond proper fastening torque in tightening the flare nut.

Fix both liquid and gas service valves at the valve main bodies as illustrated on the right, and then fasten them, applying appropriate fastening torque. Do not apply refrigerating machine oil to the flared surface. It can cause refrigerant leakage.

Service valve size (mm)	Tightening torque (N·m)	Tightening angle (°)	Recommended length of a tool handle (mm)
φ6.35 (1/4")	14 – 18	45 – 60	150
φ9.52 (3/8")	34 – 42	30 – 45	200
φ12.7 (1/2")	49 – 61	30 – 45	250
φ15.88(5/8")	68 – 82	15 – 20	300

About brazing

Brazing must be performed under a nitrogen gas flow.

Without nitrogen gas, a large quantity of foreign matters (oxidized film) are created, causing a critical failure from capillary tube or expansion valve clogging.

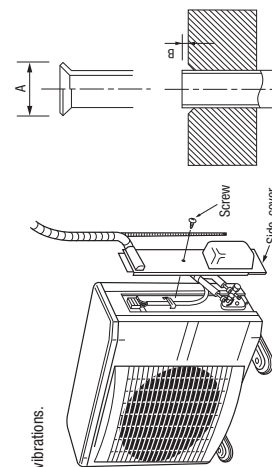
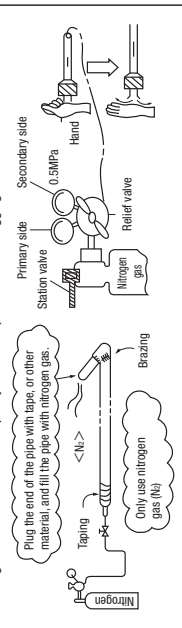

Flared pipe end: A (mm)	Copper pipe outer diameter	Copper pipe protrusion for flaring: B (mm)
0	φ6.35	0 – 0.5
A – 0.4	φ9.52	0.7 – 1.3
9.1	φ12.7	
13.2	φ15.88	
16.6		
19.7		

● In the case of a rigid (clutch) type
With an R32 tool
With a conventional tool

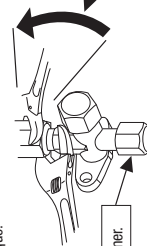

Use a torque wrench. If a torque wrench is not available, fasten the flare nut manually first and then tighten it further, using the left table as a guide.

5) Air tightness test

- ① Although outdoor and indoor units themselves have been tested for air tightness at the factory, check the connecting pipes after the installation work for air tightness from the service valve's check joint equipped on the outdoor unit side. While conducting a test, keep the service valve shut all the time.
 - a) Raise the pressure to 0.5 MPa, and then stop. Leave it for five minutes to see if the pressure drops.
 - b) Then raise the pressure to 1.5 MPa, and stop. Leave it for five more minutes to see if the pressure drops.
 - c) Then raise the pressure to the specified level (4.15 MPa), and record the ambient temperature and the pressure.
 - d) If no pressure drop is observed with an installation pressurized to the specified level and left for about one day, it is acceptable. When the ambient temperature fall 1 °C, the pressure also fall approximately 0.01 MPa. The pressure, if changed, should be compensated for.
 - e) If a pressure drop is observed in checking e) and a) - d), a leak exists somewhere. Find a leak by applying bubble test liquid to welded parts and flare joints and repair it. After repair, conduct an air-tightness test again.
- ② In conducting an air-tightness test, use nitrogen gas and pressurize the system with nitrogen gas from the gas side. Do not use a medium other than nitrogen gas under any circumstances.

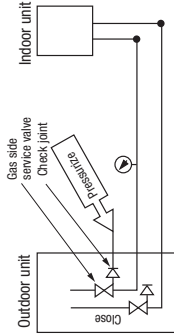

6) Evacuation

<Work flow>

Airtightness test completed

Vacuuming begins

Vacuuming completed

Vacuum gauge check

Fill refrigerant

Run the vacuum pump for at least one hour after the vacuum gauge shows -101kPa or lower (-755mmHg or lower)

Confirm that the vacuum gauge indicator does not rise even if the system is left for one hour or more.

When the system has remaining moisture inside or a leaky point, the vacuum gauge indicator will rise.
Check the system for a leaky point and then draw air to create a vacuum again.

7) Additional refrigerant charge

(1) Calculate a required refrigerant charge volume from the following table.

Item	Refrigerant volume charged for shipment at the factory (kg)	Installation's pipe length (m) covered without additional refrigerant charge
Capacity	0.054	30
Model 71V	2.75	30

- This unit contains factory charged refrigerant covering 30m of refrigerant piping and additional refrigerant charge on the installation site is not required for an installation with up to 30m refrigerant piping. When refrigerant piping exceeds 30m, additionally charge an amount calculated from the pipe length and the above table for the portion in excess of 30m.
- If an existing pipe system is used, a required refrigerant charge volume will vary depending on the liquid pipe size. For further information, please see "6. UTILIZATION OF EXISTING PIPING."

Additional charge volume (kg) = (Main pipe length (m) - Length covered without additional charge 30 (m)) × 0.054 (kg/m) + Total length of branch pipes (m) × 0.054 (kg/m)

(2) Charging refrigerant

- Since R32 refrigerant must be charged in the liquid phase, you should charge it, keeping the container cylinder upside down or using a refrigerant cylinder equipped with a siphon tube.
- Charge refrigerant always from the liquid side service port with the service valve shut. When you find it difficult to charge a required amount, fully open the outdoor unit valves on both liquid and gas sides and charge refrigerant from the gas (suction) side service port while running the unit in the cooling mode. In doing so, care must be taken so that refrigerant may be discharged from the cylinder in the liquid phase all the time. When the cylinder valve is throttled down or a dedicated conversion tool to charge liquid-phase refrigerant into mist is used to protect the compressor, however, adjust charge conditions so that refrigerant will gassy upon entering the unit.
- In charging refrigerant, always charge a calculated volume by using a scale to measure the charge volume.
- When refrigerant is charged with the unit being run, complete a charge operation within 30 minutes. Running the unit with an insufficient quantity of refrigerant for a long time can cause a compressor failure.

NOTE Put down the refrigerant volume calculated from the pipe length onto the caution label attached on the back side of the service panel.

8) Heating and condensation prevention

- (1) Dress refrigerant pipes (both gas and liquid pipes) for heat insulation and prevention of dew condensation.
 - Improper heat insulation/anti-dew dressing can result in a water leak or dripping causing damage to household effects, etc.
- (2) Use a heat insulating material that can withstand 120°C or a higher temperature. Poor heat insulating capacity can cause heat insulation problems or cable deterioration.
 - Improper heat insulation/anti-dew dressing can result in a water leak or dripping causing damage to household effects, etc.
 - All gas pipes must be securely heat insulated in order to prevent damage from dripping water that comes from the condensation formed on them during a cooling operation or personal injury from burns because their surface can reach quite a high temperature due to discharged gas flowing inside during a heating operation.
 - Wrap indoor units' flare joints with heat insulating parts (pipe cover) for heat insulation (both gas and liquid pipes).
 - Give heat insulation to both gas and liquid side pipes. Bundle a heat insulating material and a pipe tightly together so that no gaps may be left between them and wrap them together with a connecting cable by a dressing tape.
 - Although it is verified in a test that this air conditioning unit shows satisfactory performance under "JIS condensation test conditions, **both gas and liquid pipes need to be dressed with 20 mm or thicker heat insulation materials above the ceiling where relative humidity exceeds 70%.**

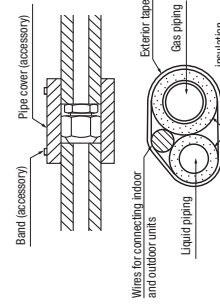

*When an additional charge volume calculation result is negative, it is not necessary to charge refrigerant additionally.

3. DRAIN PIPING WORK

- Execute drain piping by using a drain elbow and drain grommets supplied separately as optional parts, where water drained from the outdoor unit is a problem.
- Water may drip where there is a larger amount of drain water. Seal around the drain elbow and drain grommets with putty or adequate caulking material.
- Condensed water may flow out from vicinity of service valve or connected pipes.
- Where you are likely to have several days of sub-zero temperatures in a row, do not use a drain elbow and drain grommets. (There is a risk of drain water freezing inside and blocking the drain.)
- Do not use drain elbow and grommet made of plastic for drain piping when base heater for outdoor unit is used. Plastic grommet and elbow will be damaged and burnt in worst case.
- Prepare another drain tray made of metallic material for collecting drain when base heater is used.

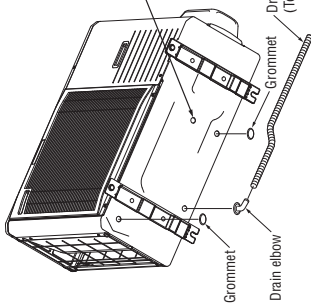

CAUTION

Do not put a grommet on this hole. This is a supplementary drain hole to discharge drain water, when a large quantity of it is gathered.

• When condensed water needs to be led to a drain, etc., install the unit on a flat base (supplied separately as an optional part) or concrete blocks. Then, please secure space for the drain elbow and the drain hose.



4. ELECTRICAL WIRING WORK For details of electrical cabling, refer to the indoor unit installation manual.

Electrical installation work must be performed by an electrical installation service provider, qualified by a power provider of the country. Electrical installation work must be executed according to the technical standards and other regulations applicable to electrical installations in the country.

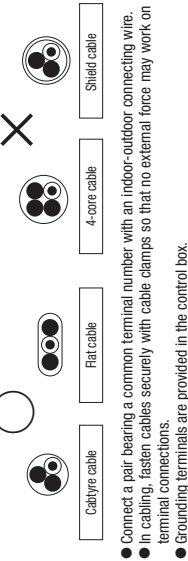

- Connect a pair bearing a common terminal number with an indoor-outdoor connecting wire.
- In cabling, fasten cables securely with cable clamps so that no external force may work on terminal connections.
- Grounding terminals are provided in the control box.

- Do not use any supply cord lighter than one specified in parentheses for each type below.
 - ordinary tough rubber sheathed cord (code designation 60245 IEC 53)
 - flat twin tinsel cord (code designation 60227 IEC 41);
- Do not use anything lighter than polychloroprene sheathed flexible cord (code designation 60245 IEC57) for supply cords of parts of appliances for outdoor use.
- Ground the unit. Do not connect the grounding wire to a gas pipe, water pipe, lightning rod or telephone grounding wire.
- If improperly grounded, an electric shock or malfunction may result.
- A grounding wire must be connected before connecting the power cable. Provide a grounding wire longer than the power cable.
- The installation of an impulse withstanding type earth leakage breaker is necessary. A failure to install an earth leakage breaker can result in an accident such as an electric shock or a fire.
- Do not turn on the power until the electrical work is completed.
- Do not use a condensive capacitor for power factor improvement under any circumstances. (It does not improve power factor, while it can cause an abnormal overheat accident)
- For power supply cables, use conduits.
- Do not lay electronic control cables (remote control and signaling wires) and other cables together outside the unit. Laying them together can result in the malfunctioning or a failure of the unit due to electric noises.
- Fasten cables so that they may not touch the piping, etc.
- When cables are connected, make sure that all electrical components within the electrical component box are free of loose connector coupling or terminal connection and then attach the cover securely. (Improper cover attachment can result in malfunctioning or a failure of the unit, if water penetrates into the box.)
- Always use a three-core cable for an indoor-outdoor connecting cable. Never use a shield cable.

Power cable, indoor-outdoor connecting wires

- Always perform grounding system installation work with the power cord unplugged.
- Connect a pair bearing a common terminal number with an indoor-outdoor connecting wire.
- In cabling, fasten cables securely with cable clamps so that no external force may work on terminal connections.
- Grounding terminals are provided in the control box.

Always use an earth leakage circuit breaker designed for inverter circuits to prevent a faulty operation.

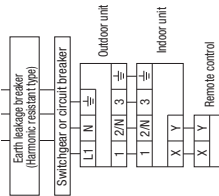

Model	Power source	Power cable thickness (mm)	MAX. over current (A)	Cable length (m)	Grounding wire thickness	Indoor-outdoor wire thickness number
71V	Single phase 3 wire 220-240V 50Hz 220V 60Hz	3.5	20	17	φ1.6mm	φ1.6mm x 3

- The specifications shown in the above table are for units without heaters. For units with heaters, refer to the installation instructions or the construction instructions of the indoor unit.
- Switchgear or circuit breaker capacity which is calculated from MAX. over current should be chosen along the regulations in each country.
 - (a) Power source cable: Use the cable which is conformed with 60245 IEC57. When selecting the power source cable length, make sure that voltage drop is less than 2%. If the wire length gets longer, increase the wire diameter.
 - (b) Indoor-Outdoor connecting wires: Use the wires which is conformed with 60245 IEC57.

Main fuse specification

Model	Specification	Part No.
71V	250V 20A	SSA564A117

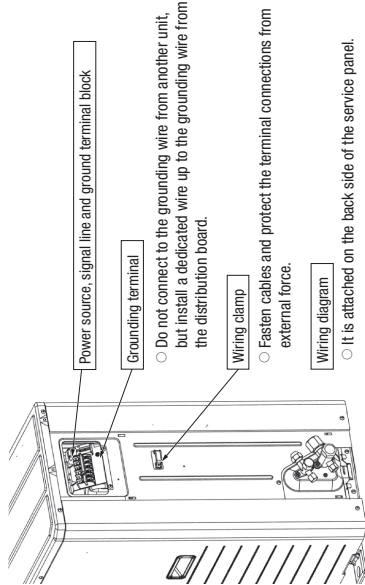

5. TEST RUN

⚠ WARNING

- Before conduct a test run, make sure that the service valves are open.
- Turn on power 6 hours prior to a test run to energize the crank case heater.
- In this operation, refrigerant may accumulate in the compressor and earth leakage breaker may be activated.
- In case of the first operation after turning on power, even if the unit does not move for 30 minutes, it is not a breakdown.
- Always give a 3-minute or longer interval before you start the unit again whenever it is stopped.
- Removing the service panel will expose high-voltage live parts and high-temperature parts, which are quite dangerous. Take utmost care not to incur an electric shock or burns. Do not leave the unit with the service panel open.

⚠ CAUTION

- When you operate switches for on-site setting, be careful not to touch a live part.
- You cannot check discharge pressure from the liquid service valve charge port.
- The 4-way valve (Z/S) is energized during a heating operation.
- When power source is cut off to reset the unit, give 3 or more minutes before you turn on power again after power is cut off. If this procedure is not observed in turning on power again, "E-5" (Communication error) may occur.

About insulation resistance

- An insulation resistance value may drop to several M ohms immediately after installation or when the unit is left for a long time without power, because refrigerant is gathered in the compressor. When the earth-leakage breaker is actuated due to low insulation resistance, please check the following:
 - (1) Check whether a normal insulation resistance value is restored about 6 hours after power is turned. Turning on power will energize the compressor and heat it to evaporate refrigerant gathered in it.
 - (2) Check whether the earth-leakage breaker is a harmonic resistant type.
 This unit is equipped with an inverter and therefore, the use of a harmonic resistant type earth-leakage breaker is necessary to prevent a false actuation.

1) Test run method

Please remove a side cover.

- (1) A test run can be initiated from an outdoor unit by using SW5-3 and SW5-4 for on-site setting.
- (2) Switching SW5-3 to ON will start the compressor.
- (3) The unit will start a cooling operation, when SW5-4 is OFF, or a heating operation, when SW5-4 is ON.
- (4) **Do not fail to switch SW5-3 to OFF when a test run is completed.**

※ In case of the first operation after turning on the power source, when the unit runs in the cooling mode at outside temperature 5°C or lower, it automatically changes into the cooling mode after it runs in the heating mode for 10 minutes.

2) Checking the state of the unit in operation

Please remove a service panel.

Use check joints provided on the piping before and after the four-way valve installed inside the outdoor unit for checking discharge pressure and suction pressure. As indicated in the table shown on the right, pressure detected at each point will vary depending on whether a cooling or heating operation has been selected.

Cooling operation	Check joint of the pipe gas service valve	Charge part of the gas service valve
Heating operation	Discharge pressure (High pressure)	Suction pressure (Low pressure)
	Suction pressure (Low pressure)	Discharge pressure (High pressure)

3) Setting SW3-1, SW3-2, SW3-3, SW3-4, on-site.

Please remove a service panel.

- (1) Defrost control switching (SW3-1)
 - When this switch is turned ON, the unit will run in the defrost mode more frequently.
 - Set this switch to ON, when installed in a region where outdoor temperature falls below zero during the season the unit is run for a heating operation.
- (2) Snow guard fan control (SW3-2)
 - When this switch is turned on, the outdoor unit fan will run for 30 seconds in every 10 minutes, when outdoor temperature falls to 3°C or lower and the compressor is not running.
 - When the unit is used in a very snowy country, set this switch to ON.
- (3) Lower noise silent mode (SW3-4)
 - Upper limit of compressor speed and fan speed becomes lower in silent mode.

4) Failure diagnosis in a test run

Error indicated on the remote control unit	Red LED	Green LED	Failure event	Action
E34	Blinking once	Blinking continuously	Open phase	Check power cables for loose contact or disconnection
E40	Blinking once	Blinking continuously	63HT actuation or operation with service valves shut (occurs mainly during a heating operation)	1. Check whether the service valves are open. 2. If an error has been cancelled when 3 minutes have elapsed since power is supplied, you can start the unit by effecting Check Reset from the remote control unit.
E49	Blinking once	Blinking continuously	Low pressure error or operation with service valves shut (occurs mainly during a cooling operation)	Reset from the remote control unit.

- If an error code other than those listed above is indicated, refer to the wiring diagram of the outdoor unit and the indoor unit.

5) The state of the electronic expansion valve.

The following table illustrates the steady states of the electronic expansion valve.

	When power is turned on	When the unit comes to a normal stop	When the unit comes to an abnormal stop
Valve for a cooling operation	Complete shut position	During a heating operation	During a cooling operation
Valve for a heating operation	Full open position	Complete shut position	Full open position

6) Heed the following on the first operation after turning on the circuit breaker.

This outdoor unit may start in the standby mode (waiting for a compressor startup), which can continue up to 30 minutes, to prevent the oil level in the compressor from lowering on the first operation after turning on the circuit breaker. If that is the case, do not suspect a unit failure.

A failure to observe these instructions can result in a compressor breakdown.

- When you leave the outdoor unit with power supplied to it, be sure to close the panel.

Item to be checked in the operation manual	Item	Check item	Check
2	Refrigerant plumbing	Have all tightness test and vacuum extraction safely performed? Are heat insulation materials installed on both liquid and gas pipes? Are service valves safely opened for both liquid and gas systems? Have you recorded the additional refrigerant charge volume and refrigerant pipe length on the power label? Is the unit free of clogging errors such as uncompleted connection, an absent or reversed phase? Are properly rated electrical equipment used for circuit breakers and cables? Don't a cabling cross-connect between units, where more than one unit is installed? Are all indoor outdoor signal wires connected to remote control wires? Do indoor outdoor connecting cables connect between the same terminal numbers? Are other VCT cables or an ORF for cables used for indoor-outdoor connecting cables?	
4	Electric wiring	Does grounding satisfy the I-type grounding type II grounding requirements? Are cables fixed on loose screws at their connection points? Are cables fixed down with cable clamps so that no external force works on the terminal connections? Is the indoor unit insulation work completed? Are there a face cover provided on an indoor unit, a face cover attached to the indoor unit?	

Test run procedure ● Always carry out a test run and check the following in order as listed.

Turn	The contents of operation	Check
(1)	Open the on-site service valve fully.	
(2)	Open the front side service valve fully.	
(3)	Close the panel.	
(4)	When a remote control unit is used for unit check on the installation site, follow instructions for unit check on the installation site with a remote control unit.	
(5)	SW5-3: SW5-4: OFF. The unit will start a cooling operation.	
(6)	SW5-3: SW5-4: ON. The unit will start a heating operation.	
(7)	When the unit starts operation, please turn the wind direction button provided on the remote control unit to check its operation.	
(8)	Place your hand before the indoor unit's diffuser to check whether cold/warm winds come out in a cooling/heating operation.	
(9)	Make sure that a red LED is not lighting.	
(10)	When you complete the test run, please turn on SW5-3 for 1 second and the sure to end a test run.	
(11)	When options are used, check their operation according to the respective instruction manuals.	

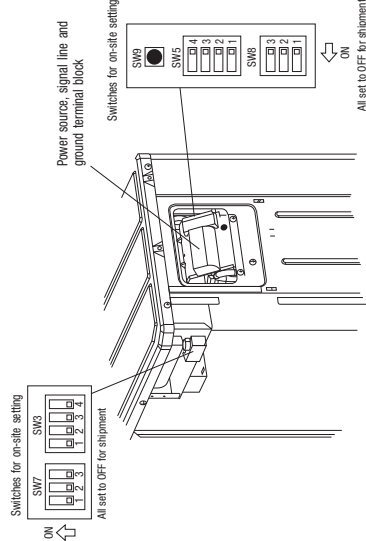

- ※1 Do not operate SW3-3, SW5-1, SW5-2, SW7, SW8-2, SW8-3.
- ※2 Refer to TECHNICAL MANUAL about SW9. (Pump down SW)

6. UTILIZATION OF EXISTING PIPING.

Check whether an existing pipe system is reusable or not by using the following flow chart.

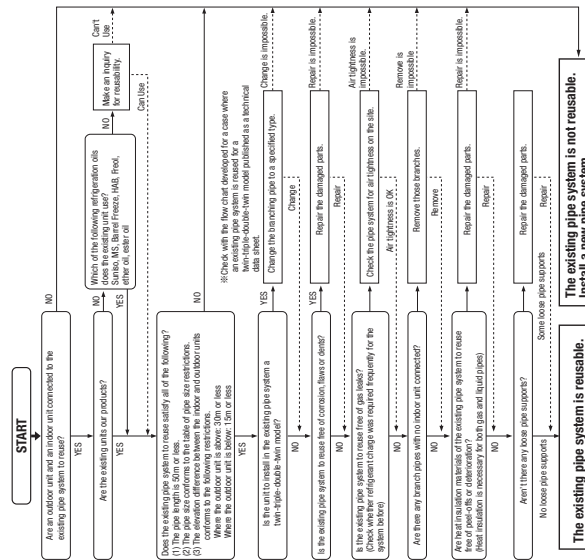

WARNING

<Where the existing unit can be run for a cooling operation ->

Carry out the following steps with the existing unit (in the order of (1), (2), (3) and (4))

- (1) Run the unit for 30 minutes for a cooling operation.
 - (2) Stop the indoor fan and run the unit for 3 minutes for a cooling operation (returning liquid)
 - (3) Close the liquid side service valve of the outdoor unit and pump down (refrigerant recovery)
 - (4) Blow with nitrogen gas. ※ If discolored refrigeration oil or any foreign matters is discharged by the blow, wash the pipe system or install a new pipe system.
- For the flare nut, do not use the old one, but use the one supplied with the outdoor unit.
 - Process a flare to the dimensions specified for R32.
 - Turn on-site setting switch SW8-1 to the ON position. (Where the gas pipe size is φ 19.05)

<Table of pipe size restrictions>

◎:Standard pipe size ○:Usable △:Restricted to shorter pipe length limits Cool 1 ; Cooling capacity drop

Pipe Size	Additional charge volume per meter of pipe		0.1kg/m
	φ9.52	φ12.7	
71V	Liquid pipe	φ9.52	φ12.7
	Gas pipe	φ12.7	φ15.88
71V	Usability	Cool 1	△
	Maximum one-way pipe length	35	50
Length covered without additional charge		30	30
		15	15

- The pipe length should be at least 5m. If the pipe length is shorter than 5m, the quantity of refrigerant needs to be reduced. Please consult with our distributor in the area, if you need to recover refrigerant and charge it again.
- Any combinations of pipe sizes not listed in the table are not usable.

<Pipe system after the branching pipe>

◎:Standard pipe size ○:Usable

Pipe Size	Additional charging amount of refrigerant per 1m		0.054kg/m
	φ9.52	φ12.7	
71V	Liquid pipe	φ9.52	φ12.7
	Gas pipe	φ12.7	φ15.88
71V	Combination type	40+40	◎
	Twin	40+40	○

- Any combinations of pipe sizes not listed in the table are not usable.

<The model types of existing units of which branching pipes are reusable ->
In case of replacement of used branching pipes, please use our genuine branching pipes.

Formula to calculate additional charge volume

$$\text{Additional charge volume (kg)} = (\text{Main pipe length (m)} - \text{Length covered without additional charge shown in the table (m)}) \times \text{Additional charge volume per meter of pipe shown in the table (kg/m)} + (\text{Total length of branch pipes (m)} \times \text{Additional charge volume per meter of pipe shown in the table (kg/m)})$$

※ If you obtain a negative figure as a result of calculation, no additional refrigerant needs to be charged.
Example) When an 71V (single installation) is installed in a 30m long existing pipe system (liquid φ12.7, gas φ15.88), the quantity of refrigerant to charge additionally should be (30m-25m) x 0.11kg/m = 0.55 kg.

<Where the existing unit cannot be run for a cooling operation ->

- Wash the pipe system or install a new pipe system.
- If you choose to wash the pipe system, contact our distributor in the area.

1.10.5 Instructions for branching pipe set (DIS-WA1, WB1, TA1, TB1)

PSB012D865

WARNING / CAUTION

- This set is for R410A and R32 refrigerant.
- Select a branching pipe set correctly rated for the combined total capacity of connected indoor units and install it according to this manual. An improperly installed branching pipe set can cause degraded performance or an abnormal unit stop.
- Provide good heat insulation to the pipes by following instructions contained in this manual.
- Improper heat insulation can result in degraded performance or a water leak accident from condensation.
- Please make sure that only parts supplied as accessories or the manufacturer's approved parts are used in installing the unit, because a leak of refrigerant can result in a lack-of-oxygen accident, if it reaches a concentration beyond the tolerable limit.

This manual explains how to use a branching pipe set that is indispensable in connecting pipes for a twin/triple/double-twin configuration installation (system). For the details of piping work, unit installation work and electrical installation work, please refer to the installation manuals and installation guides supplied with your outdoor and indoor units.

1. Branching pipe set specifications

- (1) Please make sure that you have chosen the right branching pipe set and the specifications of the parts contained in it by checking with the table below.
- (2) Connect pipes as illustrated in the table below. The pipe from an outdoor unit must be brazed to the pipe connection port "①" and the pipes from indoor units to "②," "③" and "④."

Branching pipe set type	Supported outdoor/indoor unit combinations		Part lists			
	Outdoor unit model	Indoor unit model	Branching pipe set for a liquid pipe	Branching pipe set for a gas pipe	Different diameter pipe joint	Heat insulation material
DIS-WA1 (Two-way branching set)	3HP	1.5HP + 1.5HP			Joint A ID9.52 2 pieces Flare joint (for indoor unit side connection)	
	4HP	2HP + 2HP 1.5HP + 2.5HP				
	5HP	2.5HP + 2.5HP 2HP + 3HP				
	6HP	3HP + 3HP 2HP + 4HP				
DIS-WB1 (Two-way branching set)	8HP	4HP + 4HP 3HP + 5HP			Joint C OD12.7 1 piece ID9.52	
	10HP	5HP + 5HP				
DIS-TA1 (Three-way branching set)	6HP	2HP + 2HP + 2HP			Joint A ID9.52 3 pieces Flare joint (for indoor unit side connection)	
DIS-TB1 (Three-way branching set)	8HP	3HP + 3HP + 3HP			Joint A ID9.52 2 pieces Flare joint (for indoor unit side connection) Joint B OD15.88 1 piece ID12.7 Joint D ID12.7 1 piece OD9.52	

- (3) To connect pipes for a Double Twin installation (involving 4 indoor units), please see 2-7. "Double Twin configuration."
- (4) A branching pipe set must always be installed into the posture as illustrated in the drawing below.

ID stands for inner diameter and OD, outer diameter.

< Posture to install into >

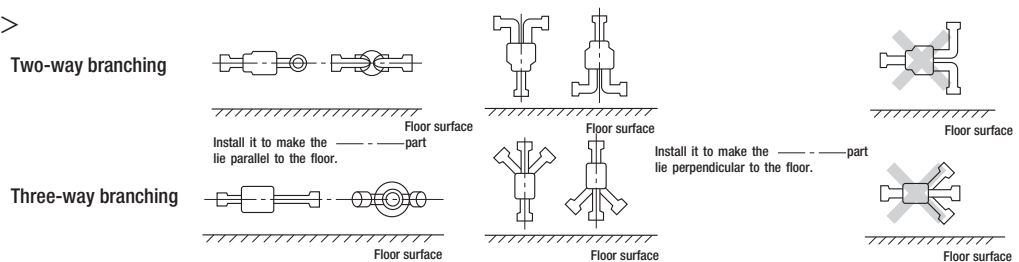

2. Pipe connecting procedure

Braze the different diameter pipe joint found in the set matching the connected outdoor and indoor unit capacities according to the instructions set out below.



CAUTION

In connecting an indoor unit of which capacity is 1.5HP, 2HP or 2.5HP, always use a $\phi 9.52$ liquid pipe to connect to the branching pipe (branching pipe – indoor unit).
 In connecting to an indoor unit (liquid pipe side: $\phi 6.35$), use the different diameter pipe joint A supplied with the set and follow the procedure set out below.

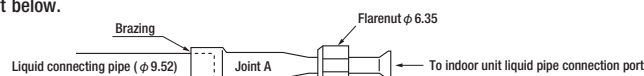

2-1 DIS-WA1

Supported combinations		Liquid branching pipe	Gas branching pipe
Outdoor unit model	Indoor unit model		
3HP	1.5HP + 1.5HP		
4HP	2HP + 2HP		
	1.5HP + 2.5HP		
5HP	2.5HP + 2.5HP		
	2HP + 3HP		
6HP	3HP + 3HP		
	2HP + 4HP		

Note When connect the indoor unit of an old model that is shown in the model list, use the joint supplied with the branch piping set like ※A

2-5. Triple type for same model/same capacity or different model/same capacity

When the difference in length of pipes after the branch is longer than 3m and shorter than 10m

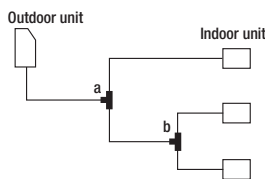

Outdoor unit model	Indoor unit model	Branching pipe	Branching pipe set type	Liquid branching pipe	Gas branching pipe
6HP	2HP + 2HP + 2HP	a	DIS-WA1		
		b			
8HP	3HP + 3HP + 3HP	a	DIS-WB1		
		b	DIS-WA1		

2-2 DIS-WB1

Supported combinations		Liquid branching pipe	Gas branching pipe
Outdoor unit model	Indoor unit model		
8HP	3HP + 5HP		
	4HP + 4HP		
10HP	5HP + 5HP		

2-3 DIS-TA1

Applicable to the difference in length of pipes after the branch being less than 3m
* Connection is not allowed when the difference in length of pipes is larger than 3m.

Supported combinations		Liquid branching pipe	Gas branching pipe
Outdoor unit model	Indoor unit model		
6HP	2HP + 2HP + 2HP		

2-4 DIS-TB1

Applicable to the difference in length of pipes after the branch being less than 3 m
* Connection is not allowed when the difference in length of pipes is larger than 3 m.

Supported combinations		Liquid branching pipe	Gas branching pipe
Outdoor unit model	Indoor unit model		
8HP	3HP + 3HP + 3HP		

2-6. Triple type for same model/different capacity or different model/different capacity

Applicable to the difference in length of pipes after the branch being less than 3m

* Connection is not allowed when the difference in length of pipes is larger than 3m.

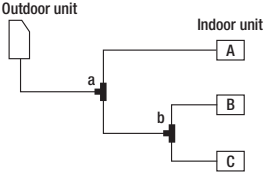

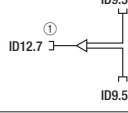
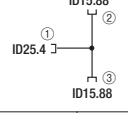
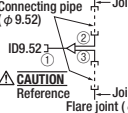
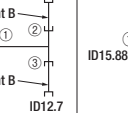
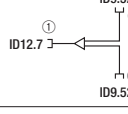
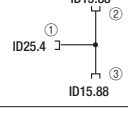
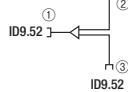
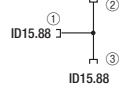
Outdoor unit model	Indoor unit model	Branching pipe	Branching pipe set type	Liquid branching pipe	Gas branching pipe
10HP	2.5HP+2.5HP+5HP	a	DIS-WB1		
		b	DIS-WA1		
10HP	3HP+3HP+4HP	a	DIS-WB1		
		b	DIS-WA1		



Connecting position

Outdoor unit model	Indoor unit model	A	B	C
10HP	2.5HP+2.5HP+5HP	5HP	2.5HP	2.5HP
	3HP+3HP+4HP	4HP	3HP	3HP

Note When connect the indoor unit of an old model that is shown in the model list, use the joint supplied with the branch piping set like ※ A.

2-7. Double Twin type

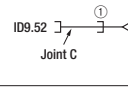
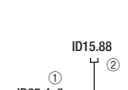
Pipes should be connected as follows for a Double Twin installation (4 connected indoor units. The capacity of an outdoor unit available for this configuration is either 8HP or 10HP only):

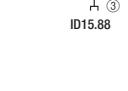
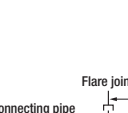
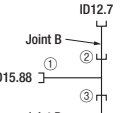
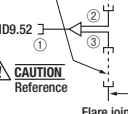
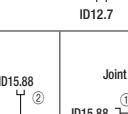
Outdoor unit capacity	Indoor unit capacity	Branching pipe	Branching pipe set type	Outdoor unit model	Liquid branching pipe	Gas branching pipe
8HP	2HP × 4 units	a	DIS-WB1	8HP		
10HP	2.5HP × 4 units			10HP		
		b	DIS-WA1	8HP		
				10HP		

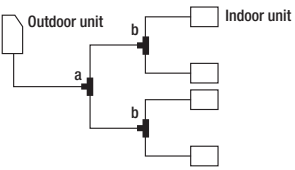

Note When connect the indoor unit of an old model that is shown in the model list, use the joint supplied with the branch piping set like ※ A.

3. Heat insulation work

- (1) Condensation can also occur on liquid pipes with this model. Please provide good heat insulation to both liquid and gas pipes.
- (2) For the heat insulation of a branching pipe, always use the heat insulation material supplied with the set and provide heat insulation according to the instructions set out below.

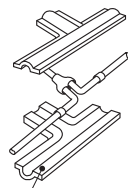

1. It has an adhesive layer on the entire inner face. Remove a separator and wrap it around the branching pipe.

Heat insulation material (for pipe insulation, etc.) to be procured locally

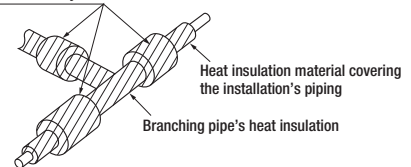







2. Apply a heat insulation material (to be procured locally) to the joint between the branching pipe's heat insulation and the heat insulation material covering the installation's piping as described above and wrap a tape over the gap shown as a hatched (///) area to complete dressing of the piping.

1.10.6 Safety precautions in handling air-conditioners with flammable refrigerants

PSA012B839A 

R32 REFRIGERANT USED

	This equipment uses flammable refrigerants. If the refrigerant is leaked, together with an external ignition source, there is a possibility of ignition.		There is information included in the user's manual and/or installation manual.
	The user's manual should be read carefully.		A service personnel should be handling this equipment with reference to the installation manual.

- This safety precaution sheet is for R32 refrigerant. If you want to know the type of refrigerant in the unit, check the label attached to the outdoor unit.
- The precautionary items mentioned below are distinguished into two levels,  **WARNING** and  **CAUTION**.

 **WARNING** : Wrong installation would cause serious consequences such as injuries or death.

 **CAUTION** : Wrong installation might cause serious consequences depending on circumstances.

WARNING

- Strict compliance of the domestic laws must be observed when disposing the appliance.
- Do not use means to accelerate the defrosting process or to clean, other than those recommended by the manufacturer.
- The appliance shall be stored in a room without continuously operating ignition sources (for example: open flames, an operating gas appliance or an operating electric heater).
- Do not pierce or burn.
- Be aware that refrigerants may not contain an odour.

CAUTION

1. General

- That the installation of pipe-work shall be kept to a minimum.
- That pipe-work shall be protected from physical damage.
- That compliance with national gas regulations shall be observed.
- That mechanical connections shall be accessible for maintenance purposes.
- Keep any required ventilation openings clear of obstruction.
- Servicing shall be performed only as recommended by the manufacturer.

2. Unventilated areas

- The appliance shall be stored in a well-ventilated area where the room size corresponds to the room area as specified for operation.

3. Qualification of workers

- The staff in servicing operations must hold the national qualification or other relevant qualifications.

4. Information on servicing

- 4.1 Checks to the area
- Prior to beginning work on systems containing flammable refrigerants, safety checks are necessary to ensure that the risk of ignition is minimised.
 - For repair to the refrigerating system, 4.3 to 4.7 shall be completed prior to conducting work on the system.
- 4.2 Work procedure
- Work shall be undertaken under a controlled procedure so as to minimise the risk of a flammable gas or vapour being present while the work is being performed.
- 4.3 General work area
- All maintenance staff and others working in the local area shall be instructed on the nature of work being carried out.
 - Work in confined spaces shall be avoided.
 - The area around the workspace shall be sectioned off.
 - Ensure that the conditions within the area have been made safe by control of flammable material.
- 4.4 Checking for presence of refrigerant
- The area shall be checked with an appropriate refrigerant detector prior to and during work, to ensure the technician is aware of potentially toxic or flammable atmospheres.
 - Ensure that the leak detection equipment being used is suitable for use with all applicable refrigerants, i.e. non-sparking, adequately sealed or intrinsically safe.

4.5 Presence of fire extinguisher

- If any hot work is to be conducted on the refrigeration equipment or any associated parts, appropriate fire extinguishing equipment shall be available to hand. Have a dry powder or CO₂ fire extinguisher adjacent to the charging area.

4.6 No ignition sources

- No person carrying out work in relation to a refrigeration system which involves exposing any pipe work shall use any sources of ignition in such a manner that it may lead to the risk of fire or explosion.
- All possible ignition sources, including cigarette smoking, should be kept sufficiently far away from the site of installation, repairing, removing and disposal, during which refrigerant can possibly be released to the surrounding space.
- Prior to work taking place, the area around the equipment is to be surveyed to make sure that there are no flammable hazards or ignition risks.
- "No Smoking" signs shall be displayed.

4.7 Ventilated area

- Ensure that the area is in the open or that it is adequately ventilated before breaking into the system or conducting any hot work.
- A degree of ventilation shall continue during the period that the work is carried out.
- The ventilation should safely disperse any released refrigerant and preferably expel it externally into the atmosphere.

4.8 Checks to the refrigeration equipment

- Where electrical components are being changed, they shall be fit for the purpose and to the correct specification.
- At all times the manufacturer's maintenance and service guidelines shall be followed.
- If in doubt consult the manufacturer's technical department for assistance.
- The following checks shall be applied to installations using flammable refrigerants:
 - the charge size is in accordance with the room size within which the refrigerant containing parts are installed;
 - the ventilation machinery and outlets are operating adequately and are not obstructed;
 - if an indirect refrigerating circuit is being used, the secondary circuit shall be checked for the presence of refrigerant;
 - marking to the equipment continues to be visible and legible. Markings and signs that are illegible shall be corrected;
 - refrigeration pipe or components are installed in a position where they are unlikely to be exposed to any substance which may corrode refrigerant containing components, unless the components are constructed of materials which are inherently resistant to being corroded or are suitably protected against being so corroded.

4.9 Checks to electrical devices

- Repair and maintenance to electrical components shall include initial safety checks and component inspection procedures.
- If a fault exists that could compromise safety, then no electrical supply shall be connected to the circuit until it is satisfactorily dealt with.
- If the fault cannot be corrected immediately but it is necessary to continue operation, an adequate temporary solution shall be used.
- This shall be reported to the owner of the equipment so all parties are advised.
- Initial safety checks shall include:
 - that capacitors are discharged: this shall be done in a safe manner to avoid possibility of sparking;
 - that no live electrical components and wiring are exposed while charging, recovering or purging the system;
 - that there is continuity of earth bonding.

5. Repairs to sealed components

- During repairs to sealed components, all electrical supplies shall be disconnected from the equipment being worked upon prior to any removal of sealed covers, etc.
- If it is absolutely necessary to have an electrical supply to equipment during servicing, then a permanently operating form of leak detection shall be located at the most critical point to warn of a potentially hazardous situation.
- Particular attention shall be paid to the following to ensure that by working on electrical components, the casing is not altered in such a way that the level of protection is affected. This shall include damage to cables, excessive number of connections, terminals not made to original specification, damage to seals, incorrect fitting of glands, etc.
- Ensure that the apparatus is mounted securely.
- Ensure that seals or sealing materials have not degraded to the point that they no longer serve the purpose of preventing the ingress of flammable atmospheres.
- Replacement parts shall be in accordance with the manufacturer's specifications.

NOTE

The use of silicon sealant can inhibit the effectiveness of some types of leak detection equipment. Intrinsically safe components do not have to be isolated prior to working on them.

⚠ CAUTION

6. Repair to intrinsically safe components

- Do not apply any permanent inductive or capacitance loads to the circuit without ensuring that this will not exceed the permissible voltage and current permitted for the equipment in use.
- Intrinsically safe components are the only types that can be worked on while live in the presence of a flammable atmosphere.
- The test apparatus shall be at the correct rating.
- Replace components only with parts specified by the manufacturer.
- Other parts may result in the ignition of refrigerant in the atmosphere from a leak.

7. Cabling

- Check that cabling will not be subject to wear, corrosion, excessive pressure, vibration, sharp edges or any other adverse environmental effects. The check shall also take into account the effects of aging or continual vibration from sources such as compressors or fans.

8. Detection of flammable refrigerants

- Under no circumstances shall potential sources of ignition be used in the searching for or detection of refrigerant leaks.
- A halide torch (or any other detector using a naked flame) shall not be used.

9. Leak detection methods

- Electronic leak detectors may be used to detect refrigerant leaks but, in the case of flammable refrigerants, the sensitivity may not be adequate, or may need re-calibration. (Detection equipment shall be calibrated in a refrigerant-free area.)
- Ensure that the detector is not a potential source of ignition and is suitable for the refrigerant used.
- Leak detection equipment shall be set at a percentage of the LFL of the refrigerant and shall be calibrated to the refrigerant employed, and the appropriate percentage of gas (25 % maximum) is confirmed.
- Leak detection fluids are suitable for use with most refrigerants but the use of detergents containing chlorine shall be avoided as the chlorine may react with the refrigerant and corrode the copper pipe-work.
- If a leak is suspected, all naked flames shall be removed/extinguished.
- If a leakage of refrigerant is found which requires brazing, all of the refrigerant shall be recovered from the system, or isolated (by means of shut off valves) in a part of the system remote from the leak.
- For appliances containing flammable refrigerants, oxygen free nitrogen (OFN) shall then be purged through the system both before and during the brazing process.

10. Removal and evacuation

- When breaking into the refrigerant circuit to make repairs – or for any other purpose – conventional procedures shall be used. However, for flammable refrigerants it is important that best practice is followed since flammability is a consideration.
- The following procedure shall be adhered to:
 - remove refrigerant;
 - purge the circuit with inert gas;
 - evacuate;
 - purge again with inert gas;
 - open the circuit by cutting or brazing.
- The refrigerant charge shall be recovered into the correct recovery cylinders.
- For appliances containing flammable refrigerants, the system shall be “flushed” with OFN to render the unit safe. This process may need to be repeated several times.
- Compressed air or oxygen shall not be used for purging refrigerant systems.

- For appliances containing flammable refrigerants, flushing shall be achieved by breaking the vacuum in the system with OFN and continuing to fill until the working pressure is achieved, then venting to atmosphere, and finally pulling down to a vacuum. This process shall be repeated until no refrigerant is within the system.
- When the final OFN charge is used, the system shall be vented down to atmospheric pressure to enable work to take place. This operation is absolutely vital if brazing operations on the pipe-work are to take place.
- Ensure that the outlet for the vacuum pump is not close to any ignition sources and that ventilation is available.

11. Charging procedures

- In addition to conventional charging procedures, the following requirements shall be followed.
 - Ensure that contamination of different refrigerants does not occur when using charging equipment. Hoses or lines shall be as short as possible to minimise the amount of refrigerant contained in them.
 - Cylinders shall be kept upright.
 - Ensure that the refrigeration system is earthed prior to charging the system with refrigerant.
 - Label the system when charging is complete (if not already).
 - Extreme care shall be taken not to overfill the refrigeration system.
- Prior to recharging the system, it shall be pressure-tested with the appropriate purging gas.
- The system shall be leak-tested on completion of charging but prior to commissioning.
- A follow up leak test shall be carried out prior to leaving the site.

12. Decommissioning

- Before carrying out this procedure, it is essential that the technician is completely familiar with the equipment and all its detail.
- It is recommended good practice that all refrigerants are recovered safely.
- Prior to the task being carried out, an oil and refrigerant sample shall be taken in case analysis is required prior to re-use of reclaimed refrigerant.
- It is essential that electrical power is available before the task is commenced.
 - a) Become familiar with the equipment and its operation.
 - b) Isolate system electrically.
 - c) Before attempting the procedure ensure that:
 - mechanical handling equipment is available, if required, for handling refrigerant cylinders;
 - all personal protective equipment is available and being used correctly;
 - the recovery process is supervised at all times by a competent person;
 - recovery equipment and cylinders conform to the appropriate standards.
 - d) Pump down refrigerant system, if possible.
 - e) If a vacuum is not possible, make a manifold so that refrigerant can be removed from various parts of the system.
 - f) Make sure that cylinder is situated on the scales before recovery takes place.
 - g) Start the recovery machine and operate in accordance with manufacturer’s instructions.
 - h) Do not overfill cylinders. (No more than 80 % volume liquid charge).
 - i) Do not exceed the maximum working pressure of the cylinder, even temporarily.
 - j) When the cylinders have been filled correctly and the process completed, make sure that the cylinders and the equipment are removed from site promptly and all isolation valves on the equipment are closed off.
 - k) Recovered refrigerant shall not be charged into another refrigeration system unless it has been cleaned and checked.

13. Labelling

- Equipment shall be labelled stating that it has been de-commissioned and emptied of refrigerant. The label shall be dated and signed.
- For appliances containing flammable refrigerants, ensure that there are labels on the equipment stating the equipment contains flammable refrigerant.

14. Recovery

- When removing refrigerant from a system, either for servicing or decommissioning, it is recommended good practice that all refrigerants are removed safely.
- When transferring refrigerant into cylinders, ensure that only appropriate refrigerant recovery cylinders are employed.
- Ensure that the correct number of cylinders for holding the total system charge are available.
- All cylinders to be used are designated for the recovered refrigerant and labelled for that refrigerant (i.e. special cylinders for the recovery of refrigerant).
- Cylinders shall be complete with pressure relief valve and associated shut-off valves in good working order.
- Empty recovery cylinders are evacuated and, if possible, cooled before recovery occurs.
- The recovery equipment shall be in good working order with a set of instructions concerning the equipment that is at hand and shall be suitable for the recovery of all appropriate refrigerants including, when applicable, flammable refrigerants.
- In addition, a set of calibrated weighing scales shall be available and in good working order.
- Hoses shall be complete with leak-free disconnect couplings and in good condition.
- Before using the recovery machine, check that it is in satisfactory working order, has been properly maintained and that any associated electrical components are sealed to prevent ignition in the event of a refrigerant release. Consult manufacturer if in doubt.
- The recovered refrigerant shall be returned to the refrigerant supplier in the correct recovery cylinder, and the relevant Waste Transfer Note arranged. Do not mix refrigerants in recovery units and especially not in cylinders.
- If compressors or compressor oils are to be removed, ensure that they have been evacuated to an acceptable level to make certain that flammable refrigerant does not remain within the lubricant.
- The evacuation process shall be carried out prior to returning the compressor to the suppliers.
- Only electric heating to the compressor body shall be employed to accelerate this process.
- When oil is drained from a system, it shall be carried out safely.

15. Other safety precautions

- A brazed, welded, or mechanical connection shall be made before opening the valves to permit refrigerant to flow between the refrigerating system parts.
- Flammable refrigerant used, refrigerant tubing protected or enclosed to avoid mechanical damage (IEC/EN 60335-2-40/A1).
- Tubing protected to extent that it will not be handled or used for carrying during moving of product (IEC/EN 60335-2-40/A1).
- Flammable refrigerant used, low temperature solder alloys, such as lead/tin alloys, not acceptable for pipe connections (IEC/EN 60335-2-40/A1).
- Do not use flare nut indoor which is locally procured.

Selection of installation location for the indoor unit

- Minimum installation area for indoor unit

⚠ CAUTION

The indoor unit shall be installed in a room with minimum installation area or more according to the refrigerant charge amount (factory refrigerant charge +additional refrigerant charge).
 For factory refrigerant charge, refer to the outdoor unit label model name or installation sheet.
 For additional refrigerant charge, refer to the outdoor unit installation sheet.

Ceiling mounted type	FDT,FDE,FDU,FDUM series
Wall mounted type	SRK series

Refrigerant charge amount [kg]		1.30	1.50	1.75	2.00	2.25	2.50	2.75	3.00	3.25	3.50	3.75	4.00	4.25	4.50	4.75
minimum installation area [m ²]	Ceiling mounted type	1.1	1.4	2.0	2.6	3.2	4.0	4.8	5.7	6.7	7.8	9.0	10.2	11.5	12.9	14.4
	Wall mounted type	1.6	2.1	2.9	3.8	4.8	6.0	7.2	8.6	10.1	11.7	13.4	15.3	17.2	19.3	21.5

Refrigerant charge amount [kg]		5.0	5.5	6.0	6.5	7.0	7.5	8.0	8.5	9.0	9.5	10.0	10.5	11.0	11.5	12.0
minimum installation area [m ²]	Ceiling mounted type	16	19	23	27	31	36	41	46	52	58	64	70	77	84	92
	Wall mounted type	24	29	34	40	47	54	61	69	77	86	95	105	115	126	137

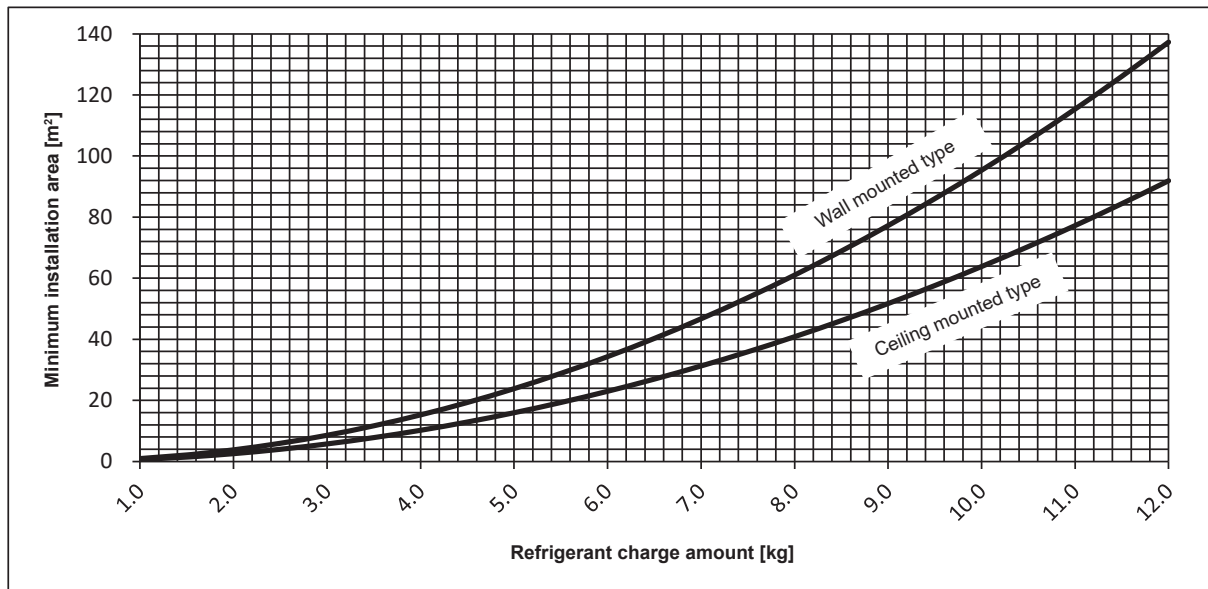

The minimum floor area [m²] is determined based on the installation height of 1.8m for wall mounted type and 2.2m for ceiling mounted type.

- Ceiling opening area

⚠ CAUTION

In case of installing the indoor unit in an enclosed ceiling space, ensure there is a sufficient ventilation opening around the unit.
 In the event of refrigerant leakage, this countermeasure would prevent an increased concentration of refrigerant.

1.11 TECHNICAL INFORMATION

(1) Ceiling cassette-4 way type (FDT)

Model FDT71VNXWVH

Information to identify the model(s) to which the information relates to:		If function includes heating: Indicate the heating season the information relates to. Indicated values should relate to one heating season at a time. Include at least the heating season 'Average'.	
Indoor unit model name	FDT71VH		
Outdoor unit model name	FDC71VNX-W		
Function(indicate if present)		Average(mandatory)	
cooling	Yes	Warmer(if designated)	No
heating	Yes	Colder(if designated)	No
Item	symbol	value	unit
Design load			
cooling	Pdesignc	7.10	kW
heating / Average	Pdesignh	5.80	kW
heating / Warmer	Pdesignh	-	kW
heating / Colder	Pdesignh	-	kW
Declared capacity at outdoor temperature Tdesignh			
heating / Average (-10°C)	Pdh	5.80	kW
heating / Warmer (2°C)	Pdh	-	kW
heating / Colder (-22°C)	Pdh	-	kW
Back up heating capacity at outdoor temperature Tdesignh			
heating / Average (-10°C)	elbu	0	kW
heating / Warmer (2°C)	elbu	-	kW
heating / Colder (-22°C)	elbu	-	kW
Declared capacity for cooling, at indoor temperature 27(19)°C and outdoor temperature Tj		Declared energy efficiency ratio, at indoor temperature 27(19)°C and outdoor temperature Tj	
Tj=35°C	Pdc	7.10	kW
Tj=30°C	Pdc	5.05	kW
Tj=25°C	Pdc	3.30	kW
Tj=20°C	Pdc	2.00	kW
Tj=35°C	EERd	4.20	-
Tj=30°C	EERd	6.44	-
Tj=25°C	EERd	10.10	-
Tj=20°C	EERd	17.90	-
Declared capacity for heating / Average season, at indoor temperature 20°C and outdoor temperature Tj		Declared coefficient of performance / Average season, at indoor temperature 20°C and outdoor temperature Tj	
Tj=-7°C	Pdh	5.10	kW
Tj=2°C	Pdh	3.10	kW
Tj=7°C	Pdh	2.00	kW
Tj=12°C	Pdh	1.50	kW
Tj=bivalent temperature	Pdh	5.80	kW
Tj=operating limit	Pdh	4.95	kW
Tj=-7°C	COPd	3.33	-
Tj=2°C	COPd	4.41	-
Tj=7°C	COPd	5.82	-
Tj=12°C	COPd	7.00	-
Tj=bivalent temperature	COPd	2.92	-
Tj=operating limit	COPd	2.19	-
Declared capacity for heating / Warmer season, at indoor temperature 20°C and outdoor temperature Tj		Declared coefficient of performance / Warmer season, at indoor temperature 20°C and outdoor temperature Tj	
Tj=2°C	Pdh	-	kW
Tj=7°C	Pdh	-	kW
Tj=12°C	Pdh	-	kW
Tj=bivalent temperature	Pdh	-	kW
Tj=operating limit	Pdh	-	kW
Tj=2°C	COPd	-	-
Tj=7°C	COPd	-	-
Tj=12°C	COPd	-	-
Tj=bivalent temperature	COPd	-	-
Tj=operating limit	COPd	-	-
Declared capacity for heating / Colder season, at indoor temperature 20°C and outdoor temperature Tj		Declared coefficient of performance / Colder season, at indoor temperature 20°C and outdoor temperature Tj	
Tj=-7°C	Pdh	-	kW
Tj=2°C	Pdh	-	kW
Tj=7°C	Pdh	-	kW
Tj=12°C	Pdh	-	kW
Tj=bivalent temperature	Pdh	-	kW
Tj=operating limit	Pdh	-	kW
Tj=-15°C	Pdh	-	kW
Tj=-7°C	COPd	-	-
Tj=2°C	COPd	-	-
Tj=7°C	COPd	-	-
Tj=12°C	COPd	-	-
Tj=bivalent temperature	COPd	-	-
Tj=operating limit	COPd	-	-
Tj=-15°C	COPd	-	-
Bivalent temperature		Operating limit temperature	
heating / Average	Tbiv	-10	°C
heating / Warmer	Tbiv	-	°C
heating / Colder	Tbiv	-	°C
heating / Average	Tol	-20	°C
heating / Warmer	Tol	-	°C
heating / Colder	Tol	-	°C
Cycling interval capacity		Cycling interval efficiency	
for cooling	Pcyc	-	kW
for heating	Pcyc	-	kW
for cooling	EERcyc	-	-
for heating	COPcyc	-	-
Degradation coefficient		Degradation coefficient	
cooling	Cdc	0.25	-
heating	Cdh	0.25	-
Electric power input in power modes other than 'active mode'		Annual electricity consumption	
off mode	Poff	15	W
standby mode	Psb	15	W
thermostat-off mode	Pto(cooling)	10	W
	Pto(heating)	28	W
crankcase heater mode	Pck	7	W
cooling	Qce	327	kWh/a
heating / Average	Qhe	1,762	kWh/a
heating / Warmer	Qhe	-	kWh/a
heating / colder	Qhe	-	kWh/a
Capacity control(indicate one of three options)		Other items	
fixed		No	
staged		No	
variable		Yes	
Sound power level(indoor)	Lwa	64	dB(A)
Sound power level(outdoor)	Lwa	66	dB(A)
Global warming potential	GWP	675	kgCO ₂ eq.
Rated air flow(indoor)	-	1,680	m ³ /h
Rated air flow(outdoor)	-	3,600	m ³ /h
Contact details for obtaining more information	Name and address of the manufacturer or of its authorised representative. Mitsubishi Heavy Industries Air-Conditioning Europe, Ltd. 5 The Square, Stockley Park, Uxbridge, Middlesex, UB11 1ET, United Kingdom		

Model FDT71VNXWPVH

Information to identify the model(s) to which the information relates to:		If function includes heating: Indicate the heating season the information relates to. Indicated values should relate to one heating season at a time. Include at least the heating season 'Average'.	
Indoor unit model name	FDT40VH (x2 units)		
Outdoor unit model name	FDC71VNX-W		
Function(indicate if present)		Average(mandatory)	
cooling	Yes	Warmer(if designated)	No
heating	Yes	Colder(if designated)	No
Item	symbol	value	unit
Design load			
cooling	Pdesignc	7.10	kW
heating / Average	Pdesignh	5.80	kW
heating / Warmer	Pdesignh	-	kW
heating / Colder	Pdesignh	-	kW
Declared capacity at outdoor temperature Tdesignh			
heating / Average (-10°C)	Pdh	5.80	kW
heating / Warmer (2°C)	Pdh	-	kW
heating / Colder (-22°C)	Pdh	-	kW
Declared capacity for cooling, at indoor temperature 27(19)°C and outdoor temperature Tj			
Tj=35°C	Pdc	7.10	kW
Tj=30°C	Pdc	5.05	kW
Tj=25°C	Pdc	3.30	kW
Tj=20°C	Pdc	2.05	kW
Declared capacity for heating / Average season, at indoor temperature 20°C and outdoor temperature Tj			
Tj=-7°C	Pdh	5.13	kW
Tj=2°C	Pdh	3.00	kW
Tj=7°C	Pdh	2.00	kW
Tj=12°C	Pdh	1.58	kW
Tj=bivalent temperature	Pdh	5.80	kW
Tj=operating limit	Pdh	5.00	kW
Declared capacity for heating / Warmer season, at indoor temperature 20°C and outdoor temperature Tj			
Tj=2°C	Pdh	-	kW
Tj=7°C	Pdh	-	kW
Tj=12°C	Pdh	-	kW
Tj=bivalent temperature	Pdh	-	kW
Tj=operating limit	Pdh	-	kW
Declared capacity for heating / Colder season, at indoor temperature 20°C and outdoor temperature Tj			
Tj=-7°C	Pdh	-	kW
Tj=2°C	Pdh	-	kW
Tj=7°C	Pdh	-	kW
Tj=12°C	Pdh	-	kW
Tj=bivalent temperature	Pdh	-	kW
Tj=operating limit	Pdh	-	kW
Tj=-15°C	Pdh	-	kW
Bivalent temperature		Operating limit temperature	
heating / Average	Tbiv	-10	°C
heating / Warmer	Tbiv	-	°C
heating / Colder	Tbiv	-	°C
heating / Average	Tol	-20	°C
heating / Warmer	Tol	-	°C
heating / Colder	Tol	-	°C
Cycling interval capacity		Cycling interval efficiency	
for cooling	Pcyc	-	kW
for heating	Pcyc	-	kW
for cooling	EERcyc	-	-
for heating	COPcyc	-	-
Degradation coefficient		Degradation coefficient	
cooling	Cdc	0.25	-
heating	Cdh	0.25	-
Electric power input in power modes other than 'active mode'		Annual electricity consumption	
off mode	Poff	18	W
standby mode	Psb	18	W
thermostat-off mode	Pto(cooling)	20	W
	Pto(heating)	35	W
crankcase heater mode	Pck	7	W
cooling	Qce	327	kWh/a
heating / Average	Qhe	1,742	kWh/a
heating / Warmer	Qhe	-	kWh/a
heating / colder	Qhe	-	kWh/a
Capacity control(indicate one of three options)		Other items	
fixed		Lwa	59 dB(A)
staged		Lwa	66 dB(A)
variable	Yes	Global warming potential	675 kgCO ₂ eq.
		Rated air flow(indoor)	780 m ³ /h
		Rated air flow(outdoor)	3,600 m ³ /h
Contact details for obtaining more information	Name and address of the manufacturer or of its authorised representative. Mitsubishi Heavy Industries Air-Conditioning Europe, Ltd. 5 The Square, Stockley Park, Uxbridge, Middlesex, UB11 1ET, United Kingdom		

(2) Ceiling cassette-4 way compact type (FDTC)

Model FDTC71VNXWPH

Information to identify the model(s) to which the information relates to:		If function includes heating: Indicate the heating season the information relates to. Indicated values should relate to one heating season at a time. Include at least the heating season 'Average'.	
Indoor unit model name	FDTC40VH (x2 units)		
Outdoor unit model name	FDC71VNX-W		
Function(indicate if present)		Average(mandatory)	
cooling	Yes	Warmer(if designated)	No
heating	Yes	Colder(if designated)	No
Item	symbol	value	unit
Design load			
cooling	Pdesignc	7.10	kW
heating / Average	Pdesignh	6.00	kW
heating / Warmer	Pdesignh	-	kW
heating / Colder	Pdesignh	-	kW
Declared capacity at outdoor temperature Tdesignh			
heating / Average (-10°C)	Pdh	6.00	kW
heating / Warmer (2°C)	Pdh	-	kW
heating / Colder (-22°C)	Pdh	-	kW
Declared capacity for cooling, at indoor temperature 27(19)°C and outdoor temperature Tj			
Tj=35°C	Pdc	7.10	kW
Tj=30°C	Pdc	5.05	kW
Tj=25°C	Pdc	3.30	kW
Tj=20°C	Pdc	2.00	kW
Declared capacity for heating / Average season, at indoor temperature 20°C and outdoor temperature Tj			
Tj=-7°C	Pdh	5.30	kW
Tj=2°C	Pdh	3.23	kW
Tj=7°C	Pdh	2.00	kW
Tj=12°C	Pdh	1.50	kW
Tj=bivalent temperature	Pdh	6.00	kW
Tj=operating limit	Pdh	4.40	kW
Declared capacity for heating / Warmer season, at indoor temperature 20°C and outdoor temperature Tj			
Tj=2°C	Pdh	-	kW
Tj=7°C	Pdh	-	kW
Tj=12°C	Pdh	-	kW
Tj=bivalent temperature	Pdh	-	kW
Tj=operating limit	Pdh	-	kW
Declared capacity for heating / Colder season, at indoor temperature 20°C and outdoor temperature Tj			
Tj=-7°C	Pdh	-	kW
Tj=2°C	Pdh	-	kW
Tj=7°C	Pdh	-	kW
Tj=12°C	Pdh	-	kW
Tj=bivalent temperature	Pdh	-	kW
Tj=operating limit	Pdh	-	kW
Tj=-15°C	Pdh	-	kW
Bivalent temperature		Operating limit temperature	
heating / Average	Tbiv	-10	°C
heating / Warmer	Tbiv	-	°C
heating / Colder	Tbiv	-	°C
heating / Average	Tol	-20	°C
heating / Warmer	Tol	-	°C
heating / Colder	Tol	-	°C
Cycling interval capacity		Cycling interval efficiency	
for cooling	Pcyc	-	kW
for heating	Pcyc	-	kW
for cooling	EERcyc	-	-
for heating	COPcyc	-	-
Degradation coefficient		Degradation coefficient	
cooling	Cdc	0.25	-
heating	Cdh	0.25	-
Electric power input in power modes other than 'active mode'		Annual electricity consumption	
off mode	Poff	20	W
standby mode	Psb	20	W
thermostat-off mode	Pto(cooling)	28	W
	Pto(heating)	50	W
crankcase heater mode	Pck	7	W
cooling	Qce	371	kWh/a
heating / Average	Qhe	1,911	kWh/a
heating / Warmer	Qhe	-	kWh/a
heating / colder	Qhe	-	kWh/a
Capacity control(indicate one of three options)		Other items	
fixed		Sound power level(indoor)	Lwa
staged	No	Sound power level(outdoor)	Lwa
variable	Yes	Global warming potential	GWP
		Rated air flow(indoor)	-
		Rated air flow(outdoor)	-
			59 dB(A)
			66 dB(A)
			675 kgCO ₂ eq.
			780 m ³ /h
			3600.0 m ³ /h
Contact details for obtaining more information	Name and address of the manufacturer or of its authorised representative. Mitsubishi Heavy Industries Air-Conditioning Europe, Ltd. 5 The Square, Stockley Park, Uxbridge, Middlesex, UB11 1ET, United Kingdom		

(3) Duct connected-High static pressure type (FDU)

Model FDU71VNXWVH

Information to identify the model(s) to which the information relates to:		If function includes heating: Indicate the heating season the information relates to. Indicated values should relate to one heating season at a time. Include at least the heating season 'Average'.	
Indoor unit model name	FDU71VH		
Outdoor unit model name	FDC71VNX-W		
Function(indicate if present)		Average(mandatory)	
cooling	Yes	Warmer(if designated)	No
heating	Yes	Colder(if designated)	No
Item	symbol	value	unit
Design load			
cooling	Pdesignc	7.10	kW
heating / Average	Pdesignh	6.00	kW
heating / Warmer	Pdesignh	-	kW
heating / Colder	Pdesignh	-	kW
Declared capacity at outdoor temperature Tdesignh			
heating / Average (-10°C)	Pdh	6.00	kW
heating / Warmer (2°C)	Pdh	-	kW
heating / Colder (-22°C)	Pdh	-	kW
Declared capacity for cooling, at indoor temperature 27(19)°C and outdoor temperature Tj			
Tj=35°C	Pdc	7.10	kW
Tj=30°C	Pdc	5.05	kW
Tj=25°C	Pdc	3.30	kW
Tj=20°C	Pdc	1.81	kW
Declared capacity for heating / Average season, at indoor temperature 20°C and outdoor temperature Tj			
Tj=-7°C	Pdh	5.30	kW
Tj=2°C	Pdh	3.23	kW
Tj=7°C	Pdh	2.00	kW
Tj=12°C	Pdh	1.50	kW
Tj=bivalent temperature	Pdh	6.00	kW
Tj=operating limit	Pdh	5.00	kW
Declared capacity for heating / Warmer season, at indoor temperature 20°C and outdoor temperature Tj			
Tj=2°C	Pdh	-	kW
Tj=7°C	Pdh	-	kW
Tj=12°C	Pdh	-	kW
Tj=bivalent temperature	Pdh	-	kW
Tj=operating limit	Pdh	-	kW
Declared capacity for heating / Colder season, at indoor temperature 20°C and outdoor temperature Tj			
Tj=-7°C	Pdh	-	kW
Tj=2°C	Pdh	-	kW
Tj=7°C	Pdh	-	kW
Tj=12°C	Pdh	-	kW
Tj=bivalent temperature	Pdh	-	kW
Tj=operating limit	Pdh	-	kW
Tj=-15°C	Pdh	-	kW
Bivalent temperature		Operating limit temperature	
heating / Average	Tbiv	-10	°C
heating / Warmer	Tbiv	-	°C
heating / Colder	Tbiv	-	°C
heating / Average		heating / Average	
heating / Warmer		heating / Warmer	
heating / Colder		heating / Colder	
Cycling interval capacity		Cycling interval efficiency	
for cooling	Pcyc	-	kW
for heating	Pcyc	-	kW
for cooling		for cooling	
for heating		for heating	
Degradation coefficient		Degradation coefficient	
cooling	Cdc	0.25	-
cooling		heating	
heating		heating	
Electric power input in power modes other than 'active mode'		Annual electricity consumption	
off mode	Poff	15	W
standby mode	Psb	15	W
thermostat-off mode	Pto(cooling)	18	W
	Pto(heating)	35	W
crankcase heater mode	Pck	7	W
cooling		cooling	
heating / Average		heating / Average	
heating / Warmer		heating / Warmer	
heating / colder		heating / colder	
Capacity control(indicate one of three options)			
fixed	No		
staged	No		
variable	Yes		
Other items			
Sound power level(indoor)	Lwa	65	dB(A)
Sound power level(outdoor)	Lwa	66	dB(A)
Global warming potential	GWP	675	kgCO ₂ eq.
Rated air flow(indoor)	-	1,440	m ³ /h
Rated air flow(outdoor)	-	3,600	m ³ /h
Contact details for obtaining more information	Name and address of the manufacturer or of its authorised representative. Mitsubishi Heavy Industries Air-Conditioning Europe, Ltd. 5 The Square, Stockley Park, Uxbridge, Middlesex, UB11 1ET, United Kingdom		

(4) Duct connected-Low/Middle static pressure type (FDUM)

Model FDUM71VNXWVH

Information to identify the model(s) to which the information relates to:		If function includes heating: Indicate the heating season the information relates to. Indicated values should relate to one heating season at a time. Include at least the heating season 'Average'.	
Indoor unit model name	FDUM71VH		
Outdoor unit model name	FDC71VNX-W		
Function(indicate if present)		Average(mandatory)	
cooling	Yes	Warmer(if designated)	No
heating	Yes	Colder(if designated)	No
Item	symbol	value	unit
Design load			
cooling	Pdesignc	7.10	kW
heating / Average	Pdesignh	6.00	kW
heating / Warmer	Pdesignh	-	kW
heating / Colder	Pdesignh	-	kW
Declared capacity at outdoor temperature Tdesignh			
heating / Average (-10°C)	Pdh	6.00	kW
heating / Warmer (2°C)	Pdh	-	kW
heating / Colder (-22°C)	Pdh	-	kW
Declared capacity for cooling, at indoor temperature 27(19)°C and outdoor temperature Tj			
Tj=35°C	Pdc	7.10	kW
Tj=30°C	Pdc	5.05	kW
Tj=25°C	Pdc	3.30	kW
Tj=20°C	Pdc	1.81	kW
Declared capacity for heating / Average season, at indoor temperature 20°C and outdoor temperature Tj			
Tj=-7°C	Pdh	5.30	kW
Tj=2°C	Pdh	3.23	kW
Tj=7°C	Pdh	2.00	kW
Tj=12°C	Pdh	1.50	kW
Tj=bivalent temperature	Pdh	6.00	kW
Tj=operating limit	Pdh	5.00	kW
Declared capacity for heating / Warmer season, at indoor temperature 20°C and outdoor temperature Tj			
Tj=2°C	Pdh	-	kW
Tj=7°C	Pdh	-	kW
Tj=12°C	Pdh	-	kW
Tj=bivalent temperature	Pdh	-	kW
Tj=operating limit	Pdh	-	kW
Declared capacity for heating / Colder season, at indoor temperature 20°C and outdoor temperature Tj			
Tj=-7°C	Pdh	-	kW
Tj=2°C	Pdh	-	kW
Tj=7°C	Pdh	-	kW
Tj=12°C	Pdh	-	kW
Tj=bivalent temperature	Pdh	-	kW
Tj=operating limit	Pdh	-	kW
Tj=-15°C	Pdh	-	kW
Bivalent temperature		Operating limit temperature	
heating / Average	Tbiv	-10	°C
heating / Warmer	Tbiv	-	°C
heating / Colder	Tbiv	-	°C
heating / Average	Tol	-20	°C
heating / Warmer	Tol	-	°C
heating / Colder	Tol	-	°C
Cycling interval capacity		Cycling interval efficiency	
for cooling	Pcyc	-	kW
for heating	Pcyc	-	kW
for cooling	EERcyc	-	-
for heating	COPcyc	-	-
Degradation coefficient		Degradation coefficient	
cooling	Cdc	0.25	-
heating	Cdh	0.25	-
Electric power input in power modes other than 'active mode'		Annual electricity consumption	
off mode	Poff	15	W
standby mode	Psb	15	W
thermostat-off mode	Pto(cooling)	18	W
	Pto(heating)	35	W
crankcase heater mode	Pck	7	W
cooling	Qce	361	kWh/a
heating / Average	Qhe	1,878	kWh/a
heating / Warmer	Qhe	-	kWh/a
heating / colder	Qhe	-	kWh/a
Capacity control(indicate one of three options)		Other items	
fixed		Sound power level(indoor)	Lwa 65 dB(A)
staged	No	Sound power level(outdoor)	Lwa 66 dB(A)
variable	Yes	Global warming potential	GWP 675 kgCO ₂ eq.
		Rated air flow(indoor)	- 1,440 m ³ /h
		Rated air flow(outdoor)	- 3,600 m ³ /h
Contact details for obtaining more information	Name and address of the manufacturer or of its authorised representative. Mitsubishi Heavy Industries Air-Conditioning Europe, Ltd. 5 The Square, Stockley Park, Uxbridge, Middlesex, UB11 1ET, United Kingdom		

Model FDUM71VNXWPVH

Information to identify the model(s) to which the information relates to:		If function includes heating: Indicate the heating season the information relates to. Indicated values should relate to one heating season at a time. Include at least the heating season 'Average'.	
Indoor unit model name	FDUM40VH x2		
Outdoor unit model name	FDC71VNX-W		
Function(indicate if present)		Average(mandatory)	
cooling	Yes	Warmer(if designated)	No
heating	Yes	Colder(if designated)	No
Item	symbol	value	unit
Seasonal efficiency and energy efficiency class			
cooling	Pdesignc	7.10	kW
heating / Average	Pdesignh	6.00	kW
heating / Warmer	Pdesignh	-	kW
heating / Colder	Pdesignh	-	kW
unit			
Declared capacity at outdoor temperature Tdesignh		Back up heating capacity at outdoor temperature Tdesignh	
heating / Average (-10°C)	Pdh	6.00	kW
heating / Warmer (2°C)	Pdh	-	kW
heating / Colder (-22°C)	Pdh	-	kW
Declared capacity for cooling, at indoor temperature 27(19)°C and outdoor temperature Tj		Declared energy efficiency ratio, at indoor temperature 27(19)°C and outdoor temperature Tj	
Tj=35°C	Pdc	7.10	kW
Tj=30°C	Pdc	5.05	kW
Tj=25°C	Pdc	3.30	kW
Tj=20°C	Pdc	1.98	kW
Declared capacity for heating / Average season, at indoor temperature 20°C and outdoor temperature Tj		Declared coefficient of performance / Average season, at indoor temperature 20°C and outdoor temperature Tj	
Tj=-7°C	Pdh	5.30	kW
Tj=2°C	Pdh	3.23	kW
Tj=7°C	Pdh	2.00	kW
Tj=12°C	Pdh	1.56	kW
Tj=bivalent temperature	Pdh	6.00	kW
Tj=operating limit	Pdh	5.00	kW
Declared capacity for heating / Warmer season, at indoor temperature 20°C and outdoor temperature Tj		Declared coefficient of performance / Warmer season, at indoor temperature 20°C and outdoor temperature Tj	
Tj=2°C	Pdh	-	kW
Tj=7°C	Pdh	-	kW
Tj=12°C	Pdh	-	kW
Tj=bivalent temperature	Pdh	-	kW
Tj=operating limit	Pdh	-	kW
Declared capacity for heating / Colder season, at indoor temperature 20°C and outdoor temperature Tj		Declared coefficient of performance / Colder season, at indoor temperature 20°C and outdoor temperature Tj	
Tj=-7°C	Pdh	-	kW
Tj=2°C	Pdh	-	kW
Tj=7°C	Pdh	-	kW
Tj=12°C	Pdh	-	kW
Tj=bivalent temperature	Pdh	-	kW
Tj=operating limit	Pdh	-	kW
Tj=-15°C	Pdh	-	kW
Bivalent temperature		Operating limit temperature	
heating / Average	Tbiv	-10	°C
heating / Warmer	Tbiv	-	°C
heating / Colder	Tbiv	-	°C
Cycling interval capacity		Cycling interval efficiency	
for cooling	Pcyc	-	kW
for heating	Pcyc	-	kW
Degradation coefficient		Degradation coefficient	
cooling	Cdc	0.25	-
Electric power input in power modes other than 'active mode'		Annual electricity consumption	
off mode	Poff	15	W
standby mode	Psb	15	W
thermostat-off mode	Pto(cooling)	18	W
crankcase heater mode	Pto(heating)	35	W
	Pck	7	W
Capacity control(indicate one of three options)		Other items	
fixed	No	Sound power level(indoor)	Lwa 65 dB(A)
staged	No	Sound power level(outdoor)	Lwa 66 dB(A)
variable	Yes	Global warming potential	GWP 675 kgCO ₂ eq.
Contact details for obtaining more information		Name and address of the manufacturer or of its authorised representative.	
		Mitsubishi Heavy Industries Air-Conditioning Europe, Ltd. 5 The Square, Stockley Park, Uxbridge, Middlesex, UB11 1ET, United Kingdom	

(5) Ceiling suspended type (FDE)

Model FDE71VNXWVH

Information to identify the model(s) to which the information relates to:		If function includes heating: Indicate the heating season the information relates to. Indicated values should relate to one heating season at a time. Include at least the heating season 'Average'.	
Indoor unit model name	FDE71VH		
Outdoor unit model name	FDC71VNX-W		
Function(indicate if present)		Average(mandatory)	
cooling	Yes	Warmer(if designated)	No
heating	Yes	Colder(if designated)	No
Item	symbol	value	unit
Design load			
cooling	Pdesignc	7.10	kW
heating / Average	Pdesignh	6.00	kW
heating / Warmer	Pdesignh	-	kW
heating / Colder	Pdesignh	-	kW
Declared capacity at outdoor temperature Tdesignh			
heating / Average (-10°C)	Pdh	6.00	kW
heating / Warmer (2°C)	Pdh	-	kW
heating / Colder (-22°C)	Pdh	-	kW
Declared capacity for cooling, at indoor temperature 27(19)°C and outdoor temperature Tj			
Tj=35°C	Pdc	7.10	kW
Tj=30°C	Pdc	5.05	kW
Tj=25°C	Pdc	3.30	kW
Tj=20°C	Pdc	2.00	kW
Declared capacity for heating / Average season, at indoor temperature 20°C and outdoor temperature Tj			
Tj=-7°C	Pdh	5.30	kW
Tj=2°C	Pdh	3.23	kW
Tj=7°C	Pdh	2.00	kW
Tj=12°C	Pdh	1.50	kW
Tj=bivalent temperature	Pdh	6.00	kW
Tj=operating limit	Pdh	4.30	kW
Declared capacity for heating / Warmer season, at indoor temperature 20°C and outdoor temperature Tj			
Tj=2°C	Pdh	-	kW
Tj=7°C	Pdh	-	kW
Tj=12°C	Pdh	-	kW
Tj=bivalent temperature	Pdh	-	kW
Tj=operating limit	Pdh	-	kW
Declared capacity for heating / Colder season, at indoor temperature 20°C and outdoor temperature Tj			
Tj=-7°C	Pdh	-	kW
Tj=2°C	Pdh	-	kW
Tj=7°C	Pdh	-	kW
Tj=12°C	Pdh	-	kW
Tj=bivalent temperature	Pdh	-	kW
Tj=operating limit	Pdh	-	kW
Tj=-15°C	Pdh	-	kW
Bivalent temperature		Operating limit temperature	
heating / Average	Tbiv	-10	°C
heating / Warmer	Tbiv	-	°C
heating / Colder	Tbiv	-	°C
heating / Average		heating / Average	
heating / Warmer		heating / Warmer	
heating / Colder		heating / Colder	
Cycling interval capacity		Cycling interval efficiency	
for cooling	Pcyc	-	kW
for heating	Pcyc	-	kW
for cooling		for cooling	
for heating		for heating	
Degradation coefficient		Degradation coefficient	
cooling	Cdc	0.25	-
cooling		cooling	
heating		heating	
Electric power input in power modes other than 'active mode'		Annual electricity consumption	
off mode	Poff	18	W
standby mode	Psb	18	W
thermostat-off mode	Pto(cooling)	20	W
	Pto(heating)	40	W
crankcase heater mode	Pck	7	W
cooling		cooling	
heating / Average		heating / Average	
heating / Warmer		heating / Warmer	
heating / colder		heating / colder	
Capacity control(indicate one of three options)			
fixed		No	
staged		No	
variable		Yes	
Other items		Sound power level(indoor)	
Sound power level(outdoor)		Sound power level(outdoor)	
Global warming potential		Global warming potential	
Rated air flow(indoor)		Rated air flow(indoor)	
Rated air flow(outdoor)		Rated air flow(outdoor)	
Contact details for obtaining more information			
Name and address of the manufacturer or of its authorised representative.			
Mitsubishi Heavy Industries Air-Conditioning Europe, Ltd.			
5 The Square, Stockley Park, Uxbridge, Middlesex, UB11 1ET,			
United Kingdom			

Model FDE71VNXWPVH

Information to identify the model(s) to which the information relates to:		If function includes heating: Indicate the heating season the information relates to. Indicated values should relate to one heating season at a time. Include at least the heating season 'Average'.	
Indoor unit model name	FDE40VHx2		
Outdoor unit model name	FDC71VNX-W		
Function(indicate if present)		Average(mandatory)	
cooling	Yes	Warmer(if designated)	No
heating	Yes	Colder(if designated)	No
Item	symbol	value	unit
Design load			
cooling	Pdesignc	7.10	kW
heating / Average	Pdesignh	6.00	kW
heating / Warmer	Pdesignh	-	kW
heating / Colder	Pdesignh	-	kW
Declared capacity at outdoor temperature Tdesignh			
heating / Average (-10°C)	Pdh	6.00	kW
heating / Warmer (2°C)	Pdh	-	kW
heating / Colder (-22°C)	Pdh	-	kW
Declared capacity for cooling, at indoor temperature 27(19)°C and outdoor temperature Tj			
Tj=35°C	Pdc	7.10	kW
Tj=30°C	Pdc	5.05	kW
Tj=25°C	Pdc	3.30	kW
Tj=20°C	Pdc	1.99	kW
Declared capacity for heating / Average season, at indoor temperature 20°C and outdoor temperature Tj			
Tj=-7°C	Pdh	5.30	kW
Tj=2°C	Pdh	3.23	kW
Tj=7°C	Pdh	2.00	kW
Tj=12°C	Pdh	1.50	kW
Tj=bivalent temperature	Pdh	6.00	kW
Tj=operating limit	Pdh	4.30	kW
Declared capacity for heating / Warmer season, at indoor temperature 20°C and outdoor temperature Tj			
Tj=2°C	Pdh	-	kW
Tj=7°C	Pdh	-	kW
Tj=12°C	Pdh	-	kW
Tj=bivalent temperature	Pdh	-	kW
Tj=operating limit	Pdh	-	kW
Declared capacity for heating / Colder season, at indoor temperature 20°C and outdoor temperature Tj			
Tj=-7°C	Pdh	-	kW
Tj=2°C	Pdh	-	kW
Tj=7°C	Pdh	-	kW
Tj=12°C	Pdh	-	kW
Tj=bivalent temperature	Pdh	-	kW
Tj=operating limit	Pdh	-	kW
Tj=-15°C	Pdh	-	kW
Bivalent temperature		Operating limit temperature	
heating / Average	Tbiv	-10	°C
heating / Warmer	Tbiv	-	°C
heating / Colder	Tbiv	-	°C
heating / Average	Tol	-20	°C
heating / Warmer	Tol	-	°C
heating / Colder	Tol	-	°C
Cycling interval capacity		Cycling interval efficiency	
for cooling	Pcyc	-	kW
for heating	Pcyc	-	kW
for cooling	EERcyc	-	-
for heating	COPcyc	-	-
Degradation coefficient		Degradation coefficient	
cooling	Cdc	0.25	-
heating	Cdh	0.25	-
Electric power input in power modes other than 'active mode'		Annual electricity consumption	
off mode	Poff	18	W
standby mode	Psb	18	W
thermostat-off mode	Pto(cooling)	28	W
	Pto(heating)	45	W
crankcase heater mode	Pck	7	W
cooling	Qce	384	kWh/a
heating / Average	Qhe	1,870	kWh/a
heating / Warmer	Qhe	-	kWh/a
heating / colder	Qhe	-	kWh/a
Capacity control(indicate one of three options)		Other items	
fixed		Sound power level(indoor)	Lwa
staged	No	Sound power level(outdoor)	Lwa
variable	Yes	Global warming potential	GWP
		Rated air flow(indoor)	-
		Rated air flow(outdoor)	-
			60 dB(A)
			66 dB(A)
			675 kgCO ₂ eq.
			780 m ³ /h
			3,600 m ³ /h
Contact details for obtaining more information	Name and address of the manufacturer or of its authorised representative. Mitsubishi Heavy Industries Air-Conditioning Europe, Ltd. 5 The Square, Stockley Park, Uxbridge, Middlesex, UB11 1ET, United Kingdom		

(6) Wall mounted type (SRK)

Model SRK71VNXWZR

Information to identify the model(s) to which the information relates to:		If function includes heating: Indicate the heating season the information relates to. Indicated values should relate to one heating season at a time. Include at least the heating season 'Average'.	
Indoor unit model name	SRK71ZR-W		
Outdoor unit model name	FDC71VNX-W		
Function(indicate if present)		Average(mandatory)	
cooling	Yes	Warmer(if designated)	No
heating	Yes	Colder(if designated)	No
Item	symbol	value	unit
Design load			
cooling	Pdesignc	7.10	kW
heating / Average	Pdesignh	5.80	kW
heating / Warmer	Pdesignh	-	kW
heating / Colder	Pdesignh	-	kW
Seasonal efficiency and energy efficiency class			
cooling	SEER	6.80	A++
heating / Average	SCOP/A	4.56	A+
heating / Warmer	SCOP/W	-	-
heating / Colder	SCOP/C	-	-
Declared capacity at outdoor temperature Tdesignh			
heating / Average (-10°C)	Pdh	5.80	kW
heating / Warmer (2°C)	Pdh	-	kW
heating / Colder (-22°C)	Pdh	-	kW
Back up heating capacity at outdoor temperature Tdesignh			
heating / Average (-10°C)	elbu	0	kW
heating / Warmer (2°C)	elbu	-	kW
heating / Colder (-22°C)	elbu	-	kW
Declared capacity for cooling, at indoor temperature 27(19)°C and outdoor temperature Tj		Declared energy efficiency ratio, at indoor temperature 27(19)°C and outdoor temperature Tj	
Tj=35°C	Pdc	7.10	kW
Tj=30°C	Pdc	5.05	kW
Tj=25°C	Pdc	3.30	kW
Tj=20°C	Pdc	1.88	kW
Tj=35°C	EERd	3.68	-
Tj=30°C	EERd	5.71	-
Tj=25°C	EERd	9.85	-
Tj=20°C	EERd	14.14	-
Declared capacity for heating / Average season, at indoor temperature 20°C and outdoor temperature Tj		Declared coefficient of performance / Average season, at indoor temperature 20°C and outdoor temperature Tj	
Tj=-7°C	Pdh	5.13	kW
Tj=2°C	Pdh	3.00	kW
Tj=7°C	Pdh	2.00	kW
Tj=12°C	Pdh	1.50	kW
Tj=bivalent temperature	Pdh	5.80	kW
Tj=operating limit	Pdh	4.40	kW
Tj=-7°C	COPd	3.40	-
Tj=2°C	COPd	4.36	-
Tj=7°C	COPd	5.65	-
Tj=12°C	COPd	6.72	-
Tj=bivalent temperature	COPd	2.96	-
Tj=operating limit	COPd	2.43	-
Declared capacity for heating / Warmer season, at indoor temperature 20°C and outdoor temperature Tj		Declared coefficient of performance / Warmer season, at indoor temperature 20°C and outdoor temperature Tj	
Tj=2°C	Pdh	-	kW
Tj=7°C	Pdh	-	kW
Tj=12°C	Pdh	-	kW
Tj=bivalent temperature	Pdh	-	kW
Tj=operating limit	Pdh	-	kW
Tj=2°C	COPd	-	-
Tj=7°C	COPd	-	-
Tj=12°C	COPd	-	-
Tj=bivalent temperature	COPd	-	-
Tj=operating limit	COPd	-	-
Declared capacity for heating / Colder season, at indoor temperature 20°C and outdoor temperature Tj		Declared coefficient of performance / Colder season, at indoor temperature 20°C and outdoor temperature Tj	
Tj=-7°C	Pdh	-	kW
Tj=2°C	Pdh	-	kW
Tj=7°C	Pdh	-	kW
Tj=12°C	Pdh	-	kW
Tj=bivalent temperature	Pdh	-	kW
Tj=operating limit	Pdh	-	kW
Tj=-15°C	Pdh	-	kW
Tj=-7°C	COPd	-	-
Tj=2°C	COPd	-	-
Tj=7°C	COPd	-	-
Tj=12°C	COPd	-	-
Tj=bivalent temperature	COPd	-	-
Tj=operating limit	COPd	-	-
Tj=-15°C	COPd	-	-
Bivalent temperature		Operating limit temperature	
heating / Average	Tbiv	-10	°C
heating / Warmer	Tbiv	-	°C
heating / Colder	Tbiv	-	°C
heating / Average	Tol	-20	°C
heating / Warmer	Tol	-	°C
heating / Colder	Tol	-	°C
Cycling interval capacity		Cycling interval efficiency	
for cooling	Pcycc	-	kW
for heating	Pcyh	-	kW
for cooling	EERcyc	-	-
for heating	COPcyc	-	-
Degradation coefficient		Degradation coefficient	
cooling	Cdc	0.25	-
heating	Cdh	0.25	-
Electric power input in power modes other than 'active mode'		Annual electricity consumption	
off mode	Poff	15	W
standby mode	Psb	15	W
thermostat-off mode	Pto(cooling)	50	W
	Pto(heating)	25	W
crankcase heater mode	Pck	7	W
cooling	Qce	366	kWh/a
heating / Average	Qhe	1,782	kWh/a
heating / Warmer	Qhe	-	kWh/a
heating / colder	Qhe	-	kWh/a
Capacity control(indicate one of three options)		Other items	
fixed		Lwa	57 dB(A)
staged	No	Lwa	66 dB(A)
variable	Yes	GWP	675 kgCO ₂ eq.
		Rated air flow(indoor)	1,230 m ³ /h
		Rated air flow(outdoor)	3,600 m ³ /h
Contact details for obtaining more information	Name and address of the manufacturer or of its authorised representative. Mitsubishi Heavy Industries Air-Conditioning Europe, Ltd. 5 The Square, Stockley Park, Uxbridge, Middlesex, UB11 1ET, United kingdom		

2. V MULTI SYSTEM

CONTENTS

2.1 GENERAL INFORMATION	131
2.1.1 How to read the model name	131
2.1.2 Table of models	131
2.1.3 Table of system combinations	131
2.2 SPECIFICATIONS	132
(1) Indoor units	132
(a) Ceiling cassette-4 way type (FDT)	132
(b) Ceiling suspended type (FDE)	133
(2) Outdoor unit	134
(3) Operation chart	135
2.3 EXTERIOR DIMENSIONS	137
2.4 ELECTRICAL WIRING	137
2.5 NOISE LEVEL	137
2.6 TEMPERATURE AND VELOCITY DISTRIBUTION	137
2.7 PIPING SYSTEM	137
2.8 RANGE OF USAGE & LIMITATIONS	137
2.9 SELECTION CHART	137
2.10 APPLICATION DATA	137
2.11 TECHNICAL INFORMATION	138

2.1 GENERAL INFORMATION

2.1.1 How to read the model name

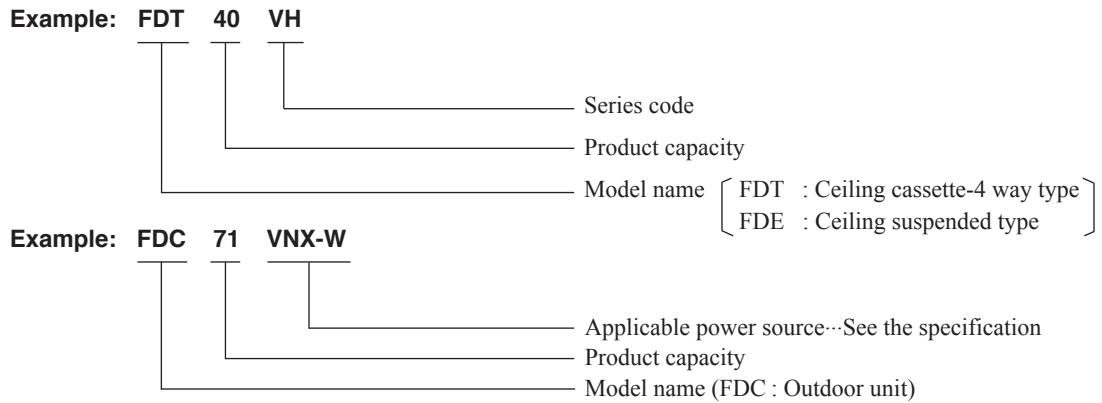

2.1.2 Table of models

Model	Capacity	40
Ceiling cassette-4 way type (FDT)		○
Ceiling suspended type (FDE)		○
Outdoor unit to be combined (FDC)		FDC71VNX-W (3 HP)

2.1.3 Table of system combinations

Outdoor unit	Type	Indoor unit assembly capacity	Branch pipe set (Option)
FDC71VNX-W	Twin	40+40	DIS-WA1G

- Notes(1) Always use the branch piping set (option) at branches in the refrigerant piping.
 (2) If wireless specifications are used, use 1 wireless indoor unit in combination with wired indoor units.
 (3) The combinations except the above table forbids.

2.2 SPECIFICATIONS

(1) Indoor units

(a) Ceiling cassette -4 way type (FDT)

Item		Model	FDT40VH
Power source			1 Phase 220-240V 50Hz / 220V 60Hz
Operation data	Sound power level	Cooling	55
		Heating	
	Sound pressure level	Cooling	P-Hi : 39 Hi : 33 Me : 31 Lo : 30
		Heating	
Silent mode sound pressure level			—
Exterior dimensions (Height × Width × Depth)		mm	Unit 246 × 840 × 840 Panel 35 × 950 × 950
Exterior appearance (Munsell color) (RAL color)			Plaster white (6.8Y8.9/0.2) near equivalent (RAL 9003) near equivalent
Net weight		kg	Unit 22 Panel 5.5
Heat exchanger			Louver fin & inner grooved tubing
Fan type & Q'ty			Turbo fan ×1
Fan motor (Starting method)		W	50 < Direct line start >
Air flow	Cooling	m ³ /min	P-Hi : 20 Hi : 18 Me : 16 Lo : 14
	Heating		
Available external static pressure		Pa	0
Outside air intake			Possible
Air filter, Quality / Quantity			Pocket plastic net ×1 (Washable)
Shock & vibration absorber			Rubber sleeve (for fan motor)
Electric heater		W	—
Operation control	Remote control		(Option) Wired : RC-EX3A , RC-E5 , RCH-E3 Wireless : RCN-T-5AW-E2
	Room temperature control		Thermostat by electronics
	Operation display		—
Safety equipments			Internal thermostat for fan motor. Frost protection thermostat.
Installation data	Refrigerant piping size (O.D.)	mm	Liquid line: φ 6.35 (1/4")
			Gas line: φ 12.7 (1/2")
	Connecting method		Flare piping
	Attached length of piping	m	—
Insulation for piping			Necessary (both Liquid & Gas lines)
Drain hose			Hose connectable VP25 (O.D.32)
Drain pump, max lift height		mm	Built-in drain pump, 850
IP number			IPX0
Standard accessories			Mounting kit, Drain hose
Option parts			—

Notes (1) The data are measured at the following conditions. The pipe length is 7.5m.

Item	Indoor air temperature		Outdoor air temperature		Standards
	DB	WB	DB	WB	
Operation					
Cooling	27°C	19°C	35°C	24°C	ISO5151-T1
Heating	20°C	—	7°C	6°C	ISO5151-H1

(2) This air-conditioner is manufactured and tested in conformity with the ISO.

(3) Sound level indicates the value in an anechoic chamber. During operation these values are somewhat higher due to ambient conditions.

(4) The operation data indicate when the air-conditioner is operated at 230V 50Hz or 220V 60Hz.

(b) Ceiling suspended type (FDE)

Item		Model		FDE40VH		
Power source		1 Phase 220-240V 50Hz / 220V 60Hz				
Operation data	Nominal cooling capacity	kW	4.0			
	Nominal heating capacity	kW	4.5			
	Sound power level	Cooling	dB(A)	60		
		Heating				
	Sound pressure level	Cooling	P-Hi : 46 Hi : 38 Me : 36 Lo : 31			
Heating						
Silent mode sound pressure level		—				
Exterior dimensions (Height x Width x Depth)		mm	210 × 1070 × 690			
Exterior appearance (Munsell color) (RAL color)		Plaster white (6.8Y8.9/0.2) near equivalent (RAL 9003) near equivalent				
Net weight		kg	28			
Heat exchanger		Louver fin & inner grooved tubing				
Fan type & Q'ty		Centrifugal fan x2				
Fan motor (Starting method)		W	30 < Direct line start >			
Air flow	Cooling	m ³ /min	P-Hi : 13 Hi : 10 Me : 9 Lo : 7			
	Heating					
Available external static pressure		Pa	0			
Outside air intake		Not possible				
Air filter, Quality / Quantity		Pocket plastic net x2(Washable)				
Shock & vibration absorber		Rubber sleeve(for fan motor)				
Electric heater		W	—			
Operation control	Remote control	(Option) Wired : RC-EX3A , RC-E5 , RCH-E3 Wireless : RCN-E-E3				
	Room temperature control	Thermostat by electronics				
	Operation display	—				
Safety equipments		Overload protection for fan motor Frost protection thermostat				
Installation data	Refrigerant piping size (O.D.)	mm	Liquid line: ϕ 6.35 (1/4") Gas line: ϕ 12.7 (1/2")			
	Connecting method	Flare piping				
	Attached length of piping	m	—			
	Insulation for piping	Necessary (both Liquid & Gas lines)				
Drain hose		Hose connectable VP20(O.D.26)				
Drain pump, max lift height		mm	—			
IP number		IPX0				
Standard accessories		Mounting kit, Drain hose				
Option parts		Motion sensor : LB-E				

Notes (1) The data are measured at the following conditions.

Operation	Item	Indoor air temperature		Outdoor air temperature		Standards
		DB	WB	DB	WB	
Cooling		27°C	19°C	35°C	24°C	ISO5151-T1
Heating		20°C	—	7°C	6°C	ISO5151-H1

(2) This air-conditioner is manufactured and tested in conformity with the ISO.

(3) Sound level indicates the value in an anechoic chamber. During operation these values are somewhat higher due to ambient conditions.

(4) The operation data indicate when the air-conditioner is operated at 230V 50Hz or 220V 60Hz.

(2) Outdoor unit

Item		Model	FDC71VNX-W			
Power source			1 Phase 220-240V 50Hz / 220V 60Hz			
Operation data	Nominal cooling capacity (range)	kW	7.1 [3.2(Min.)-8.0(Max.)]			
	Nominal heating capacity (range)	kW	8.0 [3.6(Min.)-9.0(Max.)]			
	Sound power level	Cooling	dB(A)	66		
		Heating				
	Sound pressure level	Cooling		51		
		Heating				
Silent mode sound pressure level	Cooling	49 / 47 (Normal / Silent)				
	Heating	46.5 / 45.5 (Normal / Silent)				
Exterior dimensions (Height x Width x Depth)		mm	750x880(+88)x340			
Exterior appearance (Munsell color) (RAL color)			Stucco white (4.2Y7.5/1.1) near equivalent (RAL 7044) near equivalent			
Net weight		kg	60			
Compressor type & Q'ty			RMT5118SWP×1			
Compressor motor (Starting method)		kW	Direct line start			
Refrigerant oil (Amount, type)		L	0.675 (DIAMOND FREEZE MB75)			
Refrigerant (Type, amount, pre-charge length)		kg	R32 2.75 in outdoor unit (Incl. the amount for the piping of 30m)			
Heat exchanger			M shape fin & inner grooved tubing			
Refrigerant control			Electronic expansion valve			
Fan type & Q'ty			Propeller fan ×1			
Fan motor (Starting method)		W	86 < Direct line start >			
Air flow	Cooling	m³/min	60			
	Heating		50			
Shock & vibration absorber			Rubber sleeve(for compressor)			
Electric heater		W	20(Crank case heater)			
Safety equipments			Internal thermostat for fan motor Abnormal discharge temperature protection			
Installation data	Refrigerant piping size (O.D.)	mm	Liquid line: ϕ 9.52 (3/8") Gas line: ϕ 15.88 (5/8")			
	Connecting method		Flare piping			
	Attached length of piping	m	-			
	Insulation for piping		Necessary (both Liquid & Gas lines)			
	Refrigerant line (one way) length	m	Max.50			
	Vertical height diff. between O/U and I/U	m	Max.30 (Outdoor unit is higher) Max.15 (Outdoor unit is lower)			
Drain hose			Hole size ϕ 20 x 4 pcs			
IP number			IP24			
Standard accessories			-			
Option parts			-			
Notes (1) The data are measured at the following conditions. The pipe length is 7.5m.						
	Item	Indoor air temperature		Outdoor air temperature		Standards
Operation		DB	WB	DB	WB	
	Cooling	27°C	19°C	35°C	24°C	ISO5151-T1
	Heating	20°C	-	7°C	6°C	ISO5151-H1
(2) This air-conditioner is manufactured and tested in conformity with the ISO.						
(3) Sound level indicates the value in an anechoic chamber. During operation these values are somewhat higher due to ambient conditions.						
(4) The operation data indicate when the air-conditioner is operated at 230V 50Hz or 220V 60Hz.						

(3) Operation chart

The V Multi is a system that allows for different models and capacities of indoor units to be connected so the individual operating characteristics of the indoor and outdoor are provided. Use the procedure shown in Item (c) to calculate the combined operating characteristics.

(a) Operating characteristic of outdoor unit

(220-240V 50Hz/220V 60Hz)

Item	Model	FDC71VNX-W
Cooling power consumption	kW	1.55
Heating power consumption		1.77
Cooling running current	A	6.1/6.66
Heating running current		7.02/7.66
Inrush current <Max. running current>	A	5 <19.1>

Note(1) This packaged air-conditioner is manufactured and tested in conformity with the following standard.
ISO5151-T1 "UNITARY AIR-CONDITIONERS"

(b) Operating characteristic of indoor unit

FDT series (220-240V 50Hz/220V 60Hz)

Item	Model	FDT40VH
Cooling power consumption	kW	0.03-0.03/0.03
Heating power consumption		0.03-0.03/0.03
Cooling running current	A	0.27-0.25/0.27
Heating running current		0.27-0.25/0.27

FDE series (220-240V 50Hz/220V 60Hz)

Item	Model	FDE40VH
Cooling power consumption	kW	0.05/0.05
Heating power consumption		0.05/0.05
Cooling running current	A	0.50/0.50
Heating running current		0.50/0.50

Notes(1) This packaged air-conditioner is manufactured and tested in conformity with the following standard.
ISO5151-T1 "UNITARY AIR-CONDITIONERS"

(2) The values shown in the above table are common to both cooling and heating operations.

2.3 EXTERIOR DIMENSIONS

- (1) Indoor units
 - (a) Ceiling cassette-4 way type (FDT)See page 13
 - (b) Ceiling suspended type (FDE)See page 18
- (2) Outdoor unitsSee page 21
- (3) Remote control (Option parts)See page 22

2.4 ELECTRICAL WIRING

- (1) Indoor units
 - (a) Ceiling cassette-4 way type (FDT)See page 25
 - (b) Ceiling suspended type (FDE)See page 30
- (2) Outdoor unitsSee page 32

2.5 NOISE LEVEL

- (1) Indoor units
 - (a) Ceiling cassette-4 way compact type (FDT)See page 33
 - (b) Ceiling suspended type (FDE)See page 35
- (2) Outdoor unitsSee page 36

2.6 TEMPERATURE AND VELOCITY DISTRIBUTION

- (1) Indoor units
 - (a) Ceiling cassette-4 way type (FDT)See page 39
 - (b) Ceiling suspended type (FDE)See page 42

2.7 PIPING SYSTEMSee page 44

2.8 RANGE OF USAGE & LIMITATIONSSee page 46

2.9 SELECTION CHARTSee page 49

2.10 APPLICATION DATA

2.10.1 Installation of indoor unit

- (1) Ceiling cassette-4 way type (FDT)See page 56
- (2) Ceiling suspended type (FDE)See page 82

2.10.2 Electric wiring work installationSee page 91

2.10.3 Installation of wired remote control (Option parts)See page 95

2.10.4 Installation of outdoor unitSee page 107

2.10.5 Instructions for branching pipe set (DIS-WA1,WB1,TA1,TB1)See page 115

2.10.6 Safety precautions in handling air-conditioners with flammable refrigerants.....See page 118

2.11 TECHNICAL INFORMATION

(1) Ceiling cassette-4 way type (FDT)

Model FDT40VH

Model(s) : FDT40VH							
Item	Symbol	Value	Unit	Item	Symbol	Value	Unit
Cooling capacity (sensible)	$P_{rated,c}$	3.9	kW	Total electric power input	P_{elec}	0.030	kW
Cooling capacity (latent)	$P_{rated,c}$	0.1	kW	Sound power level (per speed setting,if applicable)	L_{WA}	50.0	dB
Heating capacity	$P_{rated,h}$	4.5	kW				
Contact details	Mitsubishi heavy industries thermal systems,LTD						

(2) Ceiling suspended type (FDE)

Model FDE40VH

Model(s) : FDE40VH							
Item	Symbol	Value	Unit	Item	Symbol	Value	Unit
Cooling capacity (sensible)	$P_{rated,c}$	3.4	kW	Total electric power input	P_{elec}	0.050	kW
Cooling capacity (latent)	$P_{rated,c}$	0.6	kW	Sound power level (per speed setting,if applicable)	L_{WA}	60.0	dB
Heating capacity	$P_{rated,h}$	4.5	kW				
Contact details	Mitsubishi heavy industries thermal systems,LTD						

3. OPTION PARTS

CONTENTS

3.1 WIRELESS KIT	141
3.1.1 FDT series (RCN-T-5AW-E2)	141
3.1.2 FDTC series (RCN-TC-5AW-E2)	149
3.1.3 FDU,FDUM series (RCN-KIT4-E2)	157
3.1.4 FDE series (RCN-E-E3)	165
3.2 MOTION SENSOR KIT	173
3.2.1 FDT series (LB-T-5W-E)	173
3.2.2 FDTC series (LB-TC-5W-E)	177
3.2.3 FDU,FDUM series (LB-KIT)	181
3.2.4 FDE series (LB-E)	187
3.2.5 User's manual	191
3.3 SIMPLE WIRED REMOTE CONROL (RCH-E3)	193
3.4 OA SPACER (FDTC series)	199
3.5 DUCT JOINT (FDTC series)	203
3.6 FILTER KIT (FDUM series)	204
3.7 INTERFACE KIT (SC-BIKN2-E)	206
3.8 SUPERLINK E BOARD (SC-ADNA-E)	210

3.1 WIRELESS KIT

3.1.1 FDT series (RCN-T-5AW-E2)

Notes:

Following function of FDT indoor unit series are not able to be set with this wireless remote control (RCN-T-5AW-E2).

1. Individual flap control system

PJF012D035 













Safety precautions

- Please read this manual carefully before starting installation work to install the unit properly. Every one of the followings is important information to be observed strictly.
- ⚠ **WARNING** Failure to follow these instructions properly may result in serious consequences such as death, severe injury, etc.
- ⚠ **CAUTION** Failure to follow these instructions properly may cause injury or property damage. It could have serious consequences depending on the circumstances.
- The following pictograms are used in the text.

	Never do.		Always follow the instructions given.
---	-----------	---	---------------------------------------

- Keep this manual at a safe place where you can consult with whenever necessary. Show this manual to installers when moving or repairing the unit. When the ownership of the unit is transferred, this manual should be given to a new owner.

WARNING

-  • **Consult your dealer or a professional contractor to install the unit.**
Improper installation made on your own may cause electric shocks, fire or dropping of the unit.
-  • **Installation work should be performed properly according to this installation manual.**
Improper installation work may result in electric shocks, fire or break-down.
-  • **Be sure to use accessories and specified parts for installation work.**
Use of unspecified parts may result in drop, fire or electric shocks.
-  • **Install the unit properly to a place with sufficient strength to hold the weight.**
If the place is not strong enough, the unit may drop and cause injury.
-  • **Be sure to have the electrical wiring work done by qualified electrical installer, and use exclusive circuit.**
Power source with insufficient and improper work can cause electric shock and fire.
-  • **Shut OFF the main power source before starting electrical work.**
Otherwise, it could result in electric shocks, break-down or malfunction.
-  • **Do not modify the unit.**
It could cause electric shocks, fire, or break-down.
-  • **Be sure to turn OFF the power circuit breaker before repairing/inspecting the unit.**
Repairing/inspecting the unit with the power circuit breaker turned ON could cause electric shocks or injury.
-  • **Do not install the unit in appropriate environment or where inflammable gas could generate, flow in, accumulate or leak.**
If the unit is used at places where air contains dense oil mist, steam, organic solvent vapor, corrosive gas (ammonium, sulfuric compound, acid, etc) or where acidic or alkaline solution, special spray, etc. are used, it could cause electric shocks, break-down, smoke or fire as a result of significant deterioration of its performance or corrosion.
-  • **Do not install the unit where water vapor is generated excessively or condensation occurs.**
It could cause electric shocks, fire, or break-down.
-  • **Do not use the unit in a place where it gets wet, such as laundry room.**
It could cause electric shocks, fire, or break-down.
-  • **Do not operate the unit with wet hands.**
It could cause electric shocks.

⚠ WARNING



• **Do not wash the unit with water.**
It could cause electric shocks, fire, or break-down.



• **Use the specified cables for wiring, and connect them securely with care to protect electronic parts from external forces.**
Improper connections or fixing could cause heat generation, fire, etc.



• **When installing the unit at a hospital, telecommunication facility, etc., take measures to suppress electric noises.**
It could cause malfunction or break-down due to hazardous effects on the inverter, private power generator, high frequency medical equipment, radio communication equipment, etc. The influences transmitted from the remote control to medical or communication equipment could disrupt medical activities, video broadcasting or cause noise interference.



• **Do not leave the remote control with its PCB case removed.**
If dew, water, insect, etc. enters through the hole, it could cause electric shocks, fire or break-down.

⚠ CAUTION



• Do not install the wireless kit at the following places in order to avoid malfunction. It could cause break-down or deformation of remote control.

(1) Places exposed to direct sunlight	(8) Places where the receiver is influenced by the fluorescent lamp (especially inverter type) or sunlight
(2) Places near heat devices	(9) Places where the receiver is affected by infrared rays of any other communication devices
(3) High humidity places	(10) Places where some object may obstruct the communication with the remote control
(4) Hot surface or cold surface enough to generate condensation	
(5) Places exposed to oil mist or steam directly	
(6) Uneven surface	
(7) Places affected by the direct air flow of the AC unit	

① Accessories

Please make sure that you have all of the following accessories.

① Receiver		1	① Wireless remote control (RCN-E2)		1
② Parts set (A)		1	② Remote control holder		1
③ Installation manual		1	③ Screw for holder		2
			④ AAA dry cell battery (LR03)		2
			⑤ User's manual		1

② Preparation before installation

Setting on site

PCB on the receiver has the following switches to set the function. Default setting is shown with mark.

SW1	Prevents interference during plural setting	<input type="checkbox"/> ON : Normal	<input type="checkbox"/> OFF : Customized
SW2	Receiver master/slave setting	<input type="checkbox"/> ON : Master	<input type="checkbox"/> OFF : Slave
SW3	Buzzer	<input type="checkbox"/> ON : Valid	<input type="checkbox"/> OFF : Invalid
SW4	Auto restart	<input type="checkbox"/> ON : Valid	<input type="checkbox"/> OFF : Invalid

② Preparation before installation (continued)

To change setting

1. Remove the cover by unscrewing two screws from the back of receiver.
2. Change the setting by the switch on PCB.

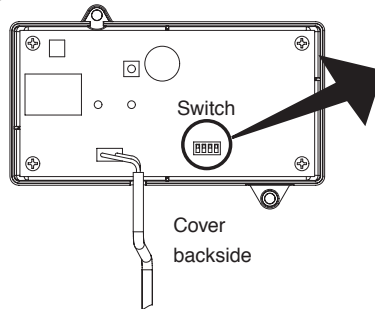
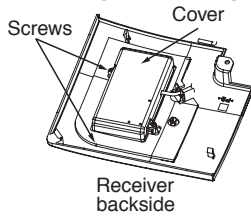

Master/Slave setting when using plural remote controls



Up to two receiver or wired remote control can be installed in one indoor unit group.
When two receiver or wired remote control are used, it is necessary to change SW on the PCB to set it as slave.

3. When SW1 is turned to OFF position, change the wireless remote control setting.
For the method of changing the setting, refer to [Setting to avoid mixed communication](#) of

④ Wireless remote control

*The receivable area of the signal refer to [⑤ Receiver](#).

③ How to install the receiver

The receiver can be installed by replacing with a corner panel on the applicable decorative panel.

Preparation before installation

- ① Attach the decorative panel onto the air-conditioner according to the installation manual for the panel.
- ② Remove the air return grille.
- ③ Remove a corner panel located on the refrigerant pipes side.
- ④ Remove three screws and detach the cover (indicated as shadowed area) from the control box of the air-conditioner.

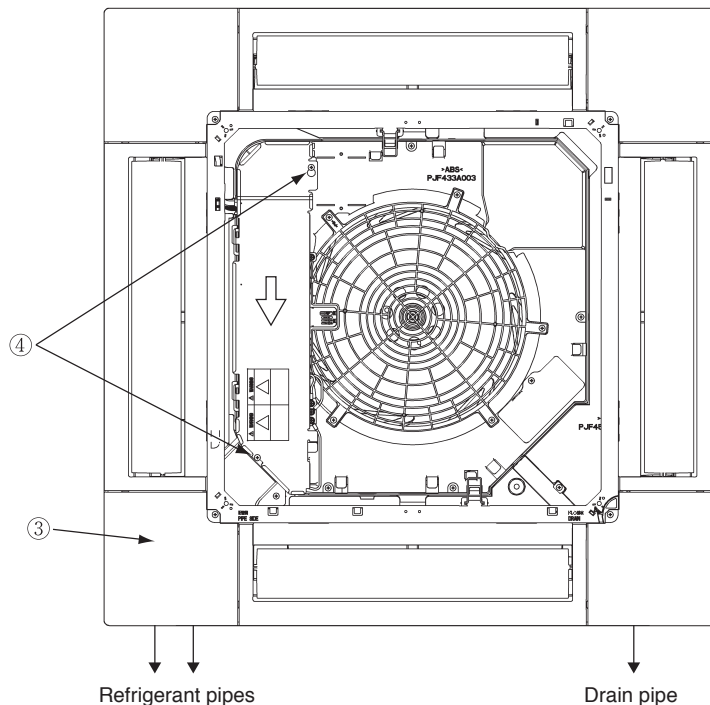

③ How to install the receiver(continued)

Installation of the receiver

- ① Loosen the bolts which fix the panel and make a gap between the panel and the indoor unit.
- ② Put the wiring of the receiver through the opening.
- ③ Put the wiring on the notch on the control box so as not to be pinched by the control box and lid as shown below.
- ④ Connect the wiring to the terminal block provided in the control box. (No polarity)
- ⑤ Attach the receiver to the panel according to the panel installation manual.
- ⑥ Fix the wiring with the clamp so that the wiring do not contact the edge of control box's metal sheet.
- ⑦ Reattach the control box lid with 3 screws removed.

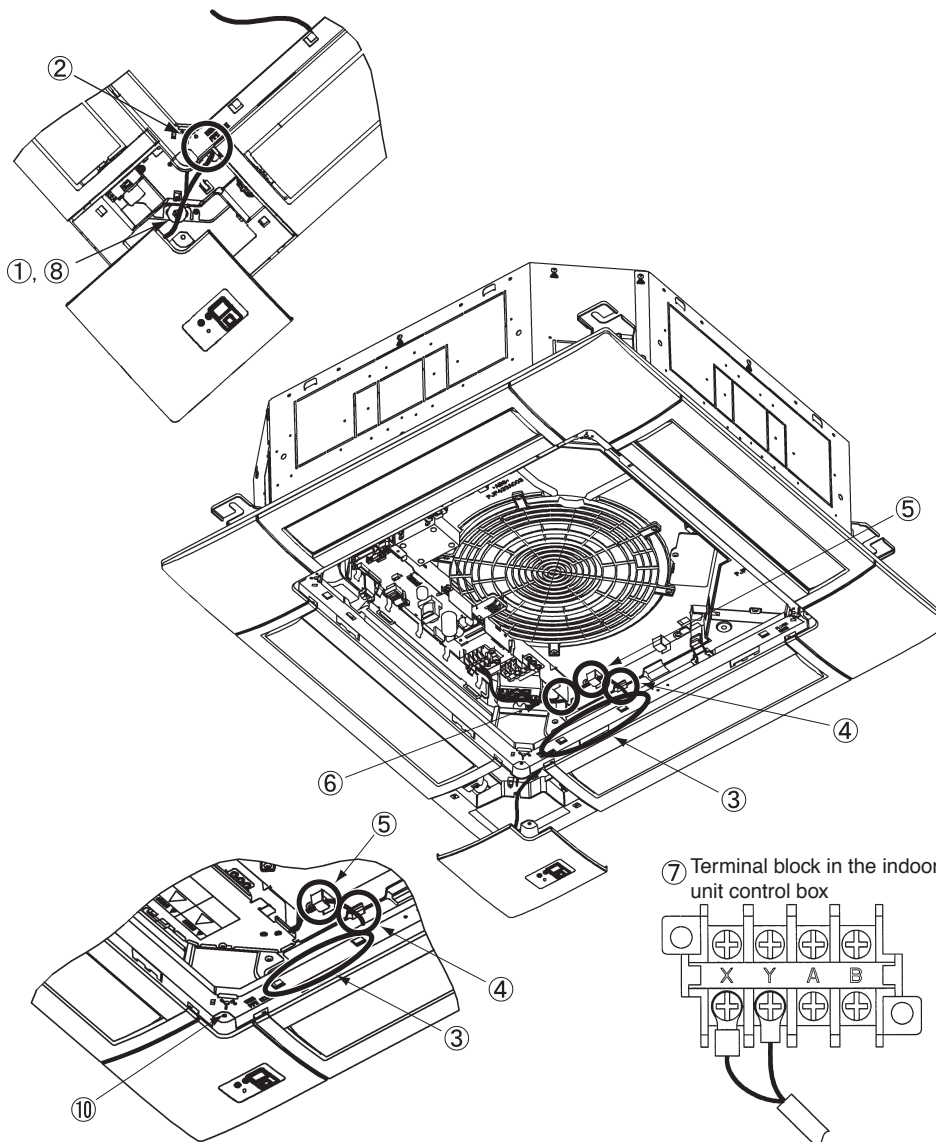

4 Wireless remote control

Installation tips for the remote control holder

Fix the remote control holder using the screws supplied with this product.

* Precautions for installing the holder

- Adjust the position so that it is upright.
- Ensure that the screw heads are not protruding.
- Do not attach the holder on plaster wall

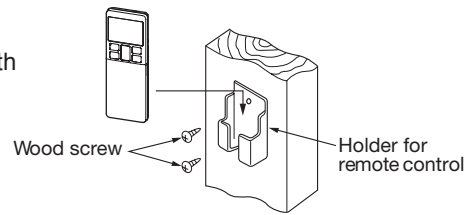

How to insert batteries

1. Detach the back lid.
2. Insert the batteries. (two AAA batteries)
3. Reattach the back lid.

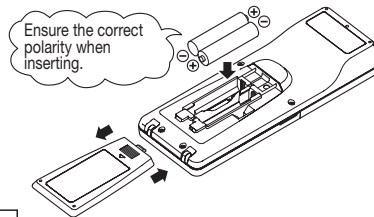

Setting to avoid mixed communication

1. Detach the back lid, and remove the batteries.
2. Cut off the switching wire in the battery compartment using nippers.
3. Insert the batteries, and attach the back lid.

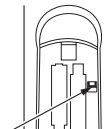

Changing the remote control setting

How to change the Auto Run setting

The Auto Run mode is not available on the building air-conditioning and gas heat pump series (excluding the cooling/heating free multi system).

When using the remote control to operate those models, set the remote control to disable the Auto Run mode.

To disable the Auto Run mode, press the **ACL** switch while holding down the **MODE** button, or insert batteries while holding down the **MODE** button.

* Note: Once the batteries are removed, the setting is reset to the factory default. When the batteries are removed, repeat the steps described above.

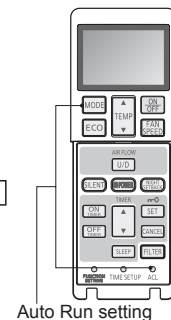

Indoor function settings

1. How to set indoor functions
 - ① Press the ON/OFF button to stop the unit.
 - ② Press the desired one of the buttons shown item 2. while holding down the FUNCTION SETTING switch.
 - ③ Use the selection buttons, ▲ and ▼, to change the setting.
 - ④ Press the SET button.

The buzzer on the remote control signal receiver beeps twice, and the LED lamp flashes four times at two-second intervals.

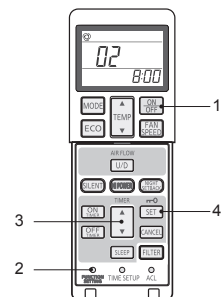

④ Wireless remote control (continued)

2. Setting details

The following functions can be set.

Button	Number indicator	Function setting
FAN SPEED	00	Fan speed setting : Standard
	01	Fan speed setting : Setting 1 *
	02	Fan speed setting : Setting 2 *
MODE	00	Room heating temperature adjustment : Disable
	01	Room heating temperature adjustment : +1°C
	02	Room heating temperature adjustment : +2°C
	03	Room heating temperature adjustment : +3°C
FILTER	00	Filter sign display : OFF
	01	Filter sign display : 180 hours
	02	Filter sign display : 600 hours
	03	Filter sign display : 1000 hours
	04	Filter sign display : Operation stop after 1000 hours have elapsed
U/P	00	Anti draft setting : Disable
	01	Anti draft setting : Enable
SILENT	00	Infrared sensor setting (Motion sensor setting) : Disable
	01	Infrared sensor setting (Motion sensor setting) : Enable
HI POWER	00	Infrared sensor control (Motion sensor control) : Disable
	01	Infrared sensor control (Motion sensor control) : Power control only
	02	Infrared sensor control (Motion sensor control) : Auto OFF only
	03	Infrared sensor control (Motion sensor control) : Power control and Auto OFF
ON TIMER	00	Cooling fan residual-period running : Disable
	01	Cooling fan residual-period running : 0.5 hours
	02	Cooling fan residual-period running : 2 hours
	03	Cooling fan residual-period running : 6 hours
OFF TIMER	00	Heating fan residual-period running : Disable
	01	Heating fan residual-period running : 0.5 hours
	02	Heating fan residual-period running : 2 hours
	03	Heating fan residual-period running : 6 hours
NIGHT SETBACK	00	Remote control signal receiver LED : Brightness High
	01	Remote control signal receiver LED : Brightness Low
	02	Remote control signal receiver LED : OFF

* Refer to service manual.

5 Receiver

1 Control plural indoor units with one remote control

Up to 16 indoor units can be connected.

1. Connect the XY terminal with 2 cores wire. As for the size, refer to the following note.
2. For Packaged air-conditioner series, set the indoor unit address with SW2 on the indoor unit PCB from [0] to [F] so as not to duplicate.

Restrictions on the thickness and length of wire (Maximum total extension 600m.)

Standard	Within	0.3 mm ² × 100m
	Within	0.5 mm ² × 200m
	Within	0.75mm ² × 300m
	Within	1.25mm ² × 400m
	Within	2.0 mm ² × 600m

For the shop series

For VRF series, set the indoor unit address with SW1, SW2 and SW5-2 on the indoor unit PCB from [000] to [127] so as not to duplicate.

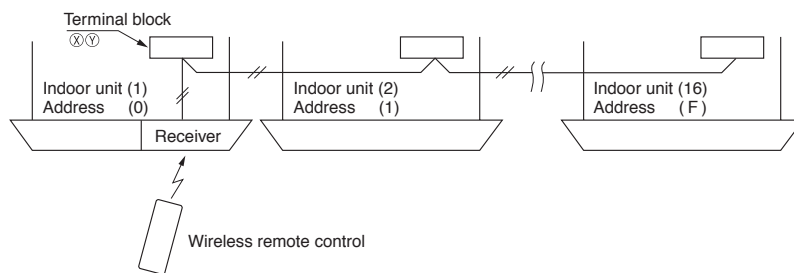

For the building air-conditioning and gas heat pump series

Set the indoor unit and outdoor unit numbers by manually specifying the addresses. Use the rotary switches SW1 and SW2 provided on the indoor unit PCB (printed circuit board) to set the indoor unit numbers so that they are not duplicated.

Master/Slave setting when using plural remote control

Up to two receivers can be installed in one indoor unit group.

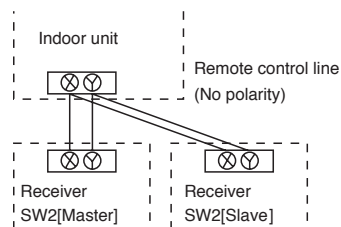

Switch	Setting	Function
SW2	ON	Master
	OFF	Slave

Wireless remote control's operable area

1. Standard reachable area of the signal
[condition] Illuminance at the receiver: 300lux
(when no lighting is installed within 1m of the receiver in an ordinary office.)

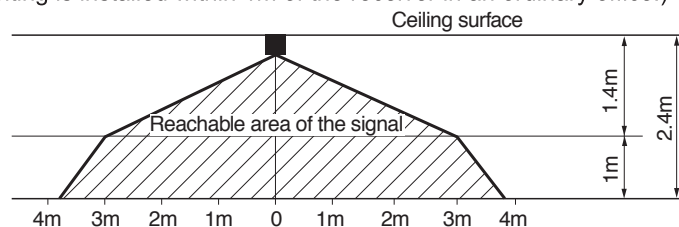

⑤ Receiver (continued)

2. Correlation between illuminance at the receiver and reachable area of the signal in a plain view. The drawing in the right shows the correlation between the reachable area of the signal and illuminance at the receiver when the remote control is operated at 1.0m high under the condition of ceiling height of 2.4m. When the illuminance becomes double, the area is narrowed down to two thirds.

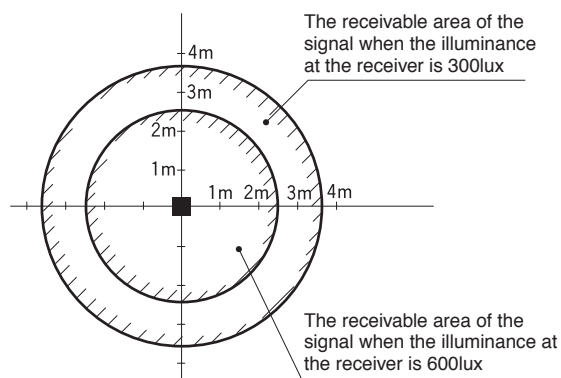

3. Installation tips when several receivers are installed close
 Minimum distance between the indoor units which can avoid cross communication is 5m under the condition of 300lux of illuminance at the receiver.
 (When no lighting is installed within 1m of the receiver in an ordinary office)

Backup switch

A backup switch is provided on the receiver. Even when the operation from the wireless remote control is not possible (due to flat batteries, control lost, or control failure), still it possible to operate as temporary means. Press the switch directly when operating it.

1. The air-conditioner starts the operation with the condition of Auto mode, 23°C of set point, High fan speed and horizontal louver position.
2. The air-conditioner stops the operation when the switch is pressed when in operation.

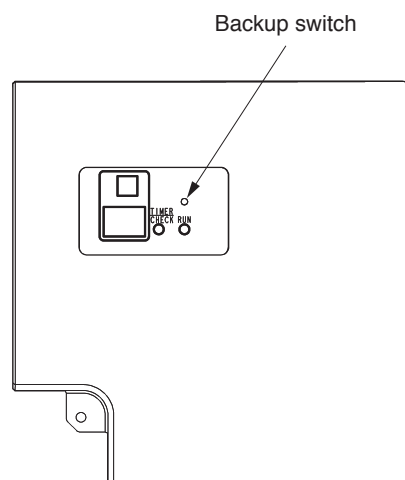

Cooling test run operation

- After safety confirmation, turn on the power.
- Transmit a cooling operation command with the wireless remote control unit, while the backup switch on the receiver is depressed.
- If the backup switch on the receiver is pressed during a test run, it will end the test run.
- If you cannot operate the unit properly during a test run, please check wiring by consulting with inspection guides.

How to read the 2-digit display

On the receiver of a wireless kit, a two-digit (7-segment) display is provided.

1. An indication will be displayed for one hour after power on.
2. An indication will be displayed for 3.5 seconds after transmitting a "STOP" command from the wireless remote control or the operation of the backup switch to stop the unit.
3. An indication appearing in (1) or (2) above will go off as soon as the unit starts operation.
4. When there are no error records to indicate, addresses of all the connected units are displayed.
5. When there are some error records remaining, the error records are displayed.
6. Error records can be cleared by transmitting a "STOP" command from the wireless remote control, while the backup button is pressed.

3.1.2 FDTC series (RCN-TC-5AW-E2)

Safety precautions

• Please read this manual carefully before starting installation work to install the unit properly. All of the following are important information to be observed strictly.

 **WARNING** Failure to follow these instructions properly may result in serious consequences such as death, severe injury, etc.













 **CAUTION** Failure to follow these instructions properly may cause injury or property damage. It could have serious consequences depending on the circumstances.

• The following symbols are used in the text.

	Never do.		Always follow the instructions given.
---	-----------	---	---------------------------------------

• Keep this manual at a safe place where you can consult with whenever necessary. Show this manual to installers when moving or repairing the unit. When the ownership of the unit is transferred, this manual should be given to the new owner.

WARNING

-  • **Consult your dealer or a professional contractor to install the unit.**
Improper installation made on your own may cause electric shocks, fire or dropping of the unit.
-  • **Installation work should be performed properly according to this installation manual.**
Improper installation work may result in electric shocks, fire or break-down.
-  • **Be sure to use accessories and specified parts for installation work.**
Use of unspecified parts may result in drop, fire or electric shocks.
-  • **Install the unit properly to a place with sufficient strength to hold the weight.**
If the place is not strong enough, the unit may drop and cause injury.
-  • **Be sure to have the electrical wiring work done by qualified electrical installer, and use exclusive circuit.**
Power source with insufficient and improper work can cause electric shock and fire.
-  • **Shut OFF the main power source before starting electrical work.**
Otherwise, it could result in electric shocks, break-down or malfunction.
-  • **Do not modify the unit.**
It could cause electric shocks, fire, or break-down.
-  • **Be sure to turn OFF the power circuit breaker before repairing/inspecting the unit.**
Repairing/inspecting the unit with the power circuit breaker turned ON could cause electric shocks or injury.
-  • **Do not install the unit in appropriate environment or where inflammable gas could generate, flow in, accumulate or leak.**
If the unit is used at places where air contains dense oil mist, steam, organic solvent vapor, corrosive gas (ammonium, sulfuric compound, acid, etc) or where acidic or alkaline solution, special spray, etc. are used, it could cause electric shocks, break-down, smoke or fire as a result of significant deterioration of its performance or corrosion.
-  • **Do not install the unit where water vapor is generated excessively or condensation occurs.**
It could cause electric shocks, fire, or break-down.
-  • **Do not use the unit in a place where it gets wet, such as laundry room.**
It could cause electric shocks, fire, or break-down.
-  • **Do not operate the unit with wet hands.**
It could cause electric shocks.

⚠ WARNING



• **Do not wash the unit with water.**
It could cause electric shocks, fire, or break-down.



• **Use the specified cables for wiring, and connect them securely with care to protect electronic parts from external forces.**
Improper connections or fixing could cause heat generation, fire, etc.



• **When installing the unit at a hospital, telecommunication facility, etc., take measures to suppress electric noises.**
It could cause malfunction or break-down due to hazardous effects on the inverter, private power generator, high frequency medical equipment, radio communication equipment, etc. The influences transmitted from the remote control to medical or communication equipment could disrupt medical activities, video broadcasting or cause noise interference.



• **Do not leave the remote control with its PCB case removed.**
If dew, water, insect, etc. enter through the hole, it could cause electric shocks, fire or break-down.

⚠ CAUTION



• Do not install the wireless kit at the following places in order to avoid malfunction. It could cause break-down or deformation of remote control.

(1) Places exposed to direct sunlight	(8) Places where the receiver is influenced by fluorescent lamp (especially inverter type) or sunlight
(2) Places near heat-generating devices	(9) Places where the receiver is affected by infrared rays of any other communication devices
(3) High humidity places	(10) Places where some object may obstruct the communication with the remote control
(4) Hot surface or cold surface enough to generate condensation	
(5) Places exposed to oil mist or steam directly	
(6) Uneven surface	
(7) Places affected by the direct air flow of the AC unit	

① Accessories

Please make sure that you have all of the following accessories.

① Receiver		1	⑤ Bracket mounting screw		1
② PCB		1	⑥ Wiring (For communication)		1
③ PCB mounting support		2	⑦ Wiring (For receiving)		1
④ Bracket (Sheet metal)		1	⑧ Installation manual		1
			⑨ Parts set		1

① Wireless remote control (RCN-E2)		1
② Remote control holder		1
③ Screw for holder		2
④ AAA dry cell battery (LR03)		2
⑤ User's manual		1

② Preparation before installation

Setting of PCB

Accessory PCB has the following switches to set the functions. Default setting is shown with mark.

SW1	Prevents interference during multiple setting	<input type="checkbox"/> ON : Normal	<input type="checkbox"/> OFF : Remote
SW2	Receiver master/slave setting	<input type="checkbox"/> ON : Master	<input type="checkbox"/> OFF : Slave
SW3	Buzzer	<input type="checkbox"/> ON : Valid	<input type="checkbox"/> OFF : Invalid
SW4	Auto restart	<input type="checkbox"/> ON : Valid	<input type="checkbox"/> OFF : Invalid

② Preparation before installation (continued)

To change setting

1. Change the setting of switches on the accessory PCB.

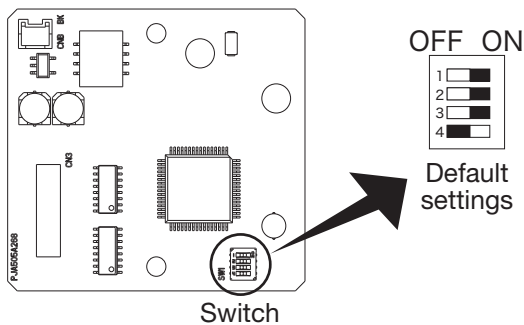

Master/Slave setting when using multiple remote controls

Up to two receivers or wired remote controls can be installed on one indoor unit group. In such occasion, it is necessary to change the setting to slave on either one.

To change the setting on the receiver, refer to the instruction manual of the receiver.

2. When SW1 is turned to OFF position, change the wireless remote control setting.

For the method of changing the setting, refer to **Setting to avoid mixed communication** of

④ Wireless remote control

*For the receivable area of the signal, refer to **⑤ Receiver**.

③ How to install the receiver

It is possible to install the receiver by replacing the corner lid on the panel.

Preparation before installation

- ① Remove the inlet grille according to the installation manual of the panel.
- ② Remove the corner lid at the refrigerant pipe side.
- ③ Loosen screws (2 pcs) on the control box of the unit.
- ④ Slide the control lid in the arrow direction, and remove it.

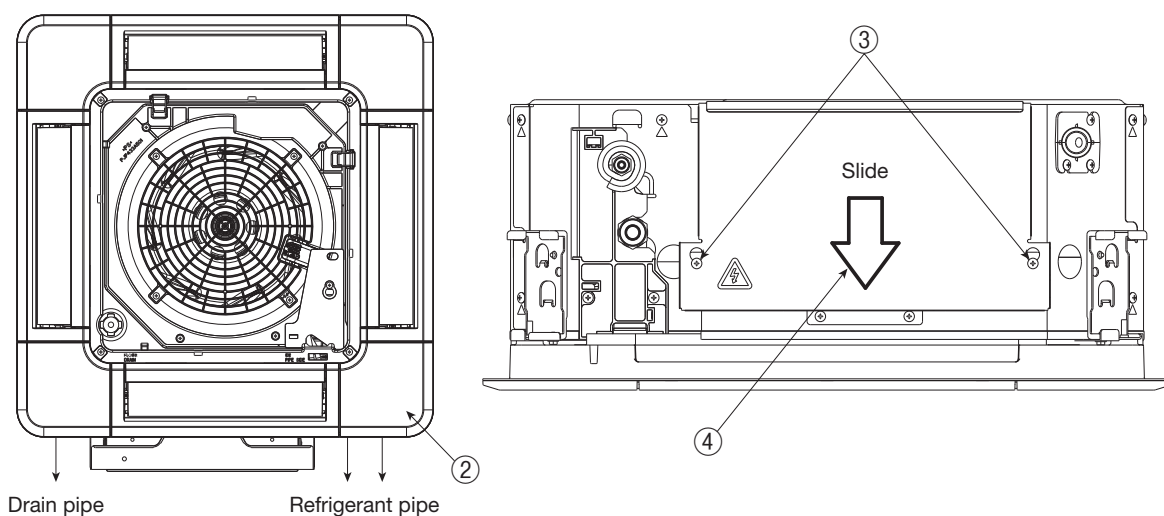

③ How to install the receiver(continued)

Installation of the receiver

- ① Connect the wire connector (Communication) to CNB on PCB.
- ② Connect the wire connector (Receiver) to CN3 on PCB.
- ③ Install the PCB mounting supports on the bracket (Sheet metal).
- ④ Install PCB on the PCB mounting supports.
- ⑤ Insert the bracket (Sheet metal) in one side of control box, and fix the other side with screws as shown in the figure.
- ⑥ Connect round terminals of wires (Communication) to the terminal block (X, Y) in the control box. The wires have no polarity.
- ⑦ Fix wires with bands as shown in the figure.
- ⑧ Cut off the half-blanks on the panel (at 4 places) as shown in the figure.
- ⑨ Pass the wiring (Communication) through the opening on the panel.
- ⑩ Connect connectors of the wiring (Communication) and the receiver.
- ⑪ Install the receiver on the panel according to the installation manual of the panel.
- ⑫ Install the control box lid with care not to pinch wires, and fix with screws (2 pcs).

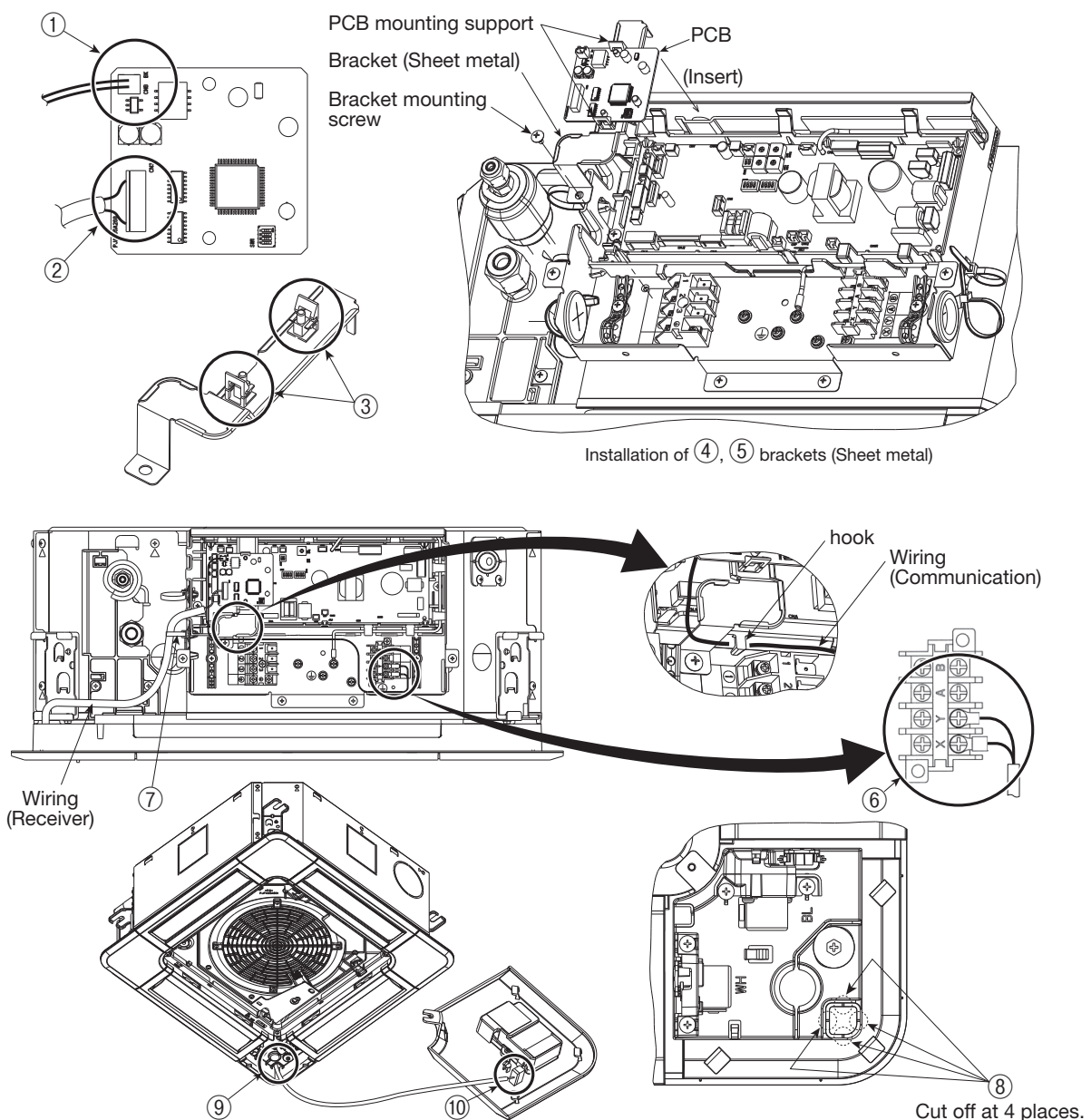

④ Wireless remote control

Installation tips for the remote control holder

Fix the remote control holder using the screws supplied with this product.

* Precautions for installing the holder

- Adjust the position so that it is upright.
- Ensure that the screw heads are not protruding.
- Do not attach the holder on plaster wall.

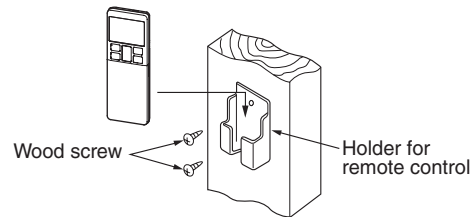

How to insert batteries

1. Detach the back lid.
2. Insert the batteries. (two AAA batteries)
3. Reattach the back lid.

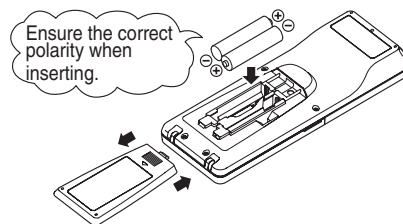

Setting to avoid mixed communication

1. Detach the back lid, and remove the batteries.
2. Cut off the switching wire in the battery compartment using nippers.
3. Insert the batteries, and attach the back lid.

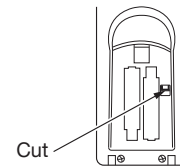

Changing the remote control setting

How to change the Auto Run setting

The Auto Run mode is not available on the building air-conditioning and gas heat pump series (excluding the cooling/heating free multi system).

When using the remote control to operate those models, set the remote control to disable the Auto Run mode.

To disable the Auto Run mode, press the **ACL** switch while holding down the **MODE** button, or insert batteries while holding down the **MODE** button.

* Note: Once the batteries are removed, the setting is reset to the factory default. When the batteries are removed, repeat the steps described above.

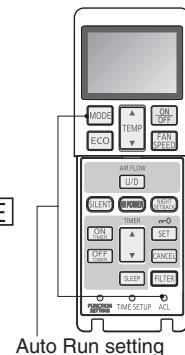

Indoor function settings

1. How to set indoor functions
 - ① Press the ON/OFF button to stop the unit.
 - ② Press the desired one of the buttons shown item 2. while holding down the FUNCTION SETTING switch.
 - ③ Use the selection buttons ▲ and ▼ to change the setting.
 - ④ Press the SET button.

The buzzer on the remote control signal receiver beeps twice, and the LED lamp flashes four times at two-second intervals.

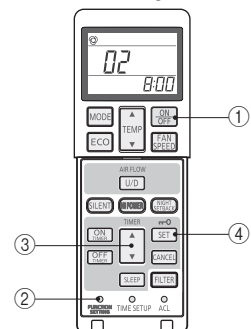

④ Wireless remote control (continued)

2. Setting details

The following functions can be set.

Button	Number indicator	Function setting
FAN SPEED	00	Fan speed setting : Standard
	01	Fan speed setting : Setting 1 *
	02	Fan speed setting : Setting 2 *
MODE	00	Room heating temperature adjustment : Disable
	01	Room heating temperature adjustment : +1°C
	02	Room heating temperature adjustment : +2°C
	03	Room heating temperature adjustment : +3°C
FILTER	00	Filter sign display : OFF
	01	Filter sign display : 180 hours
	02	Filter sign display : 600 hours
	03	Filter sign display : 1000 hours
	04	Filter sign display : Operation stop after 1000 hours have elapsed
U/P (Up/Down)	00	Anti draft setting : Disable
	01	Anti draft setting : Enable
SILENT	00	Infrared sensor setting (Motion sensor setting) : Disable
	01	Infrared sensor setting (Motion sensor setting) : Enable
HI POWER	00	Infrared sensor control (Motion sensor control) : Disable
	01	Infrared sensor control (Motion sensor control) : Power control only
	02	Infrared sensor control (Motion sensor control) : Auto OFF only
	03	Infrared sensor control (Motion sensor control) : Power control + Auto OFF
ON TIMER	00	Cooling fan residual-period running : Disable
	01	Cooling fan residual-period running : 0.5 hours
	02	Cooling fan residual-period running : 2 hours
	03	Cooling fan residual-period running : 6 hours
OFF TIMER	00	Heating fan residual-period running : Disable
	01	Heating fan residual-period running : 0.5 hours
	02	Heating fan residual-period running : 2 hours
	03	Heating fan residual-period running : 6 hours
NIGHT SETBACK	00	Remote control signal receiver LED : Brightness High
	01	Remote control signal receiver LED : Brightness Low
	02	Remote control signal receiver LED : OFF

* Refer to service manual.

⑤ Receiver

1 Control multiple indoor units with one remote control

Up to 16 indoor units can be connected.

1. Connect the XY terminal with 2 cores wire. As for the size, refer to the note on the right.
2. For Packaged air-conditioner series, set the indoor unit address with SW2 on the indoor unit PCB from [1] to [F] so as not to duplicate.

Restrictions on the thickness and length of wire (Maximum length is 600m.)

Standard	Within	0.3 mm ² × 100m
	Within	0.5 mm ² × 200m
	Within	0.75mm ² × 300m
	Within	1.25mm ² × 400m
	Within	2.0 mm ² × 600m

For the shop series

For VRF series, set the indoor unit address with SW1, SW2 and SW5-2 on the indoor unit PCB from [000] to [127] so as not to duplicate.

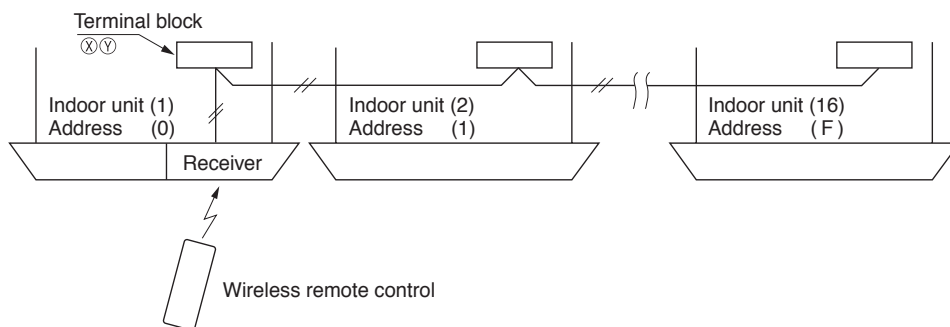

For the building air-conditioning and gas heat pump series

Set the indoor unit and outdoor unit numbers by manually specifying the addresses.

Use the rotary switches SW1 and SW2 provided on the indoor unit PCB (printed circuit board) to set the indoor unit numbers so that they are not duplicated.

Master/Slave setting when using multiple remote control

Up to two receivers can be installed in one indoor unit group.

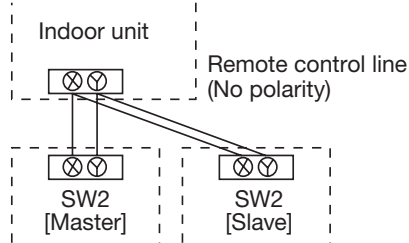

Switch	Setting	Function
SW2	ON	Master
	OFF	Slave

Wireless remote control's operable area

1. Standard reachable area of the signal

[Condition] Illuminance at the receiver: 300lux

(When no lighting is installed within 1m of the receiver in an ordinary office)

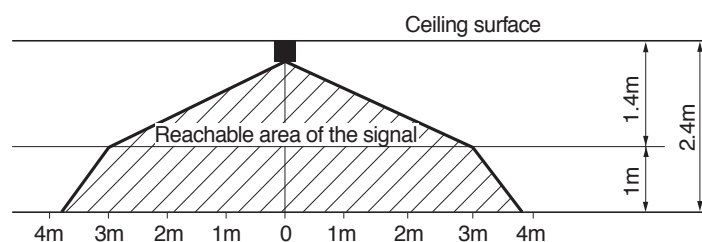

⑤ Receiver (continued)

2. Correlation between illuminance at the receiver and reachable area of the signal in a plain view.

The drawing in the right shows the correlation between the reachable area of the signal and illuminance at the receiver when the remote control is operated at 1m high under the condition of ceiling height of 2.4m. When the illuminance becomes double, the area is narrowed down to two thirds.

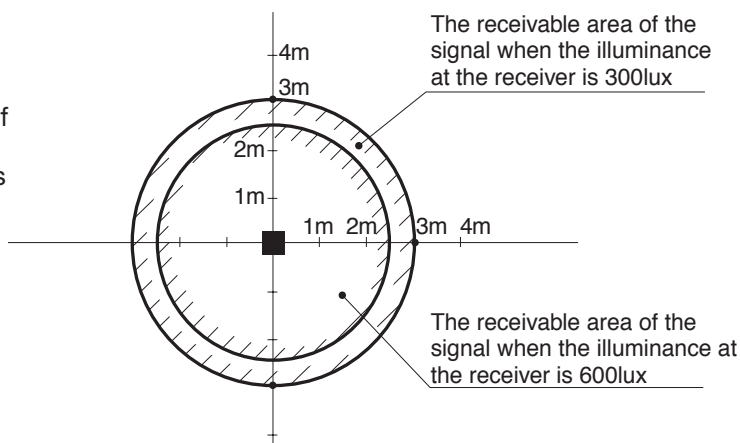

3. Installation tips when several receivers are installed close to one another.

Minimum distance between the indoor units which can avoid cross communication is 5m under the condition of 300lux of illuminance at the receiver.

(When no lighting is installed within 1m of the receiver in an ordinary office)

Backup switch

A backup switch is provided on the receiver section of the panel surface.

When operation from the wireless remote control unit is not possible (due to flat batteries, a mislaid unit, a unit failure), you can use it as an emergency means. You should operate this switch manually.

1. If pressed while the air-conditioner is in a halt, it will cause the air-conditioner to start operation in the automatic mode (In case of cooling only, it is in the cooling mode).
Wind speed: Hi fan, Temperature setting: 23°C, Louver: horizontal
2. If pressed while the air-conditioner is in operation, it will stop the air-conditioner.

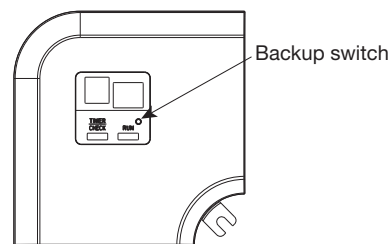

Cooling test run operation

- After safety confirmation, turn on the power.
- Transmit a cooling operation command with the wireless remote control unit, while the backup switch on the receiver is pressed.
- If the backup switch on the receiver is pressed during a test run, it will end the test run.
- If you cannot operate the unit properly during a test run, please check wiring by consulting with inspection guides.

How to read the two-digit display

On the receiver of a wireless kit, a two-digit (7-segment) display is provided.

1. An indication will be displayed for one hour after power on.
2. An indication will be displayed for 3.5 seconds after transmitting a "STOP" command from the wireless remote control or the operation of the backup switch to stop the unit.
3. An indication appearing in (1) or (2) above will go off as soon as the unit starts operation.
4. When there are no error records to indicate, addresses of all the connected units are displayed.
5. When there are some error records remaining, the error records are displayed.
6. Error records can be cleared by transmitting a "STOP" command from the wireless remote control, while the backup button is pressed.

3.1.3 FDU,FDUM series (RCN-KIT4-E2)

PJZ012D112 













Safety precautions

- Please read this manual carefully before starting installation work to install the unit properly. Every one of the followings is important information to be observed strictly.
 - ⚠ **WARNING** Failure to follow these instructions properly may result in serious consequences such as death, severe injury, etc.
 - ⚠ **CAUTION** Failure to follow these instructions properly may cause injury or property damage. It could have serious consequences depending on the circumstances.
- The following pictograms are used in the text.

	Never do.		Always follow the instructions given.
---	-----------	---	---------------------------------------

- Keep this manual at a safe place where you can consult with whenever necessary. Show this manual to installers when moving or repairing the unit. When the ownership of the unit is transferred, this manual should be given to a new owner.

WARNING

-  • **Consult your dealer or a professional contractor to install the unit.**
Improper installation made on your own may cause electric shocks, fire or dropping of the unit.
-  • **Installation work should be performed properly according to this installation manual.**
Improper installation work may result in electric shocks, fire or break-down.
-  • **Be sure to use accessories and specified parts for installation work.**
Use of unspecified parts may result in drop, fire or electric shocks.
-  • **Install the unit properly to a place with sufficient strength to hold the weight.**
If the place is not strong enough, the unit may drop and cause injury.
-  • **Be sure to have the electrical wiring work done by qualified electrical installer, and use exclusive circuit.**
Power source with insufficient and improper work can cause electric shock and fire.
-  • **Shut OFF the main power source before starting electrical work.**
Otherwise, it could result in electric shocks, break-down or malfunction.
-  • **Do not modify the unit.**
It could cause electric shocks, fire, or break-down.
-  • **Be sure to turn OFF the power circuit breaker before repairing/inspecting the unit.**
Repairing/inspecting the unit with the power circuit breaker turned ON could cause electric shocks or injury.
-  • **Do not install the unit in appropriate environment or where inflammable gas could generate, flow in, accumulate or leak.**
If the unit is used at places where air contains dense oil mist, steam, organic solvent vapor, corrosive gas (ammonium, sulfuric compound, acid, etc) or where acidic or alkaline solution, special spray, etc. are used, it could cause electric shocks, break-down, smoke or fire as a result of significant deterioration of its performance or corrosion.
-  • **Do not install the unit where water vapor is generated excessively or condensation occurs.**
It could cause electric shocks, fire, or break-down.
-  • **Do not use the unit in a place where it gets wet, such as laundry room.**
It could cause electric shocks, fire, or break-down.
-  • **Do not operate the unit with wet hands.**
It could cause electric shocks.

⚠ WARNING



• **Do not wash the unit with water.**
It could cause electric shocks, fire, or break-down.



• **Use the specified cables for wiring, and connect them securely with care to protect electronic parts from external forces.**
Improper connections or fixing could cause heat generation, fire, etc.



• **When installing the unit at a hospital, telecommunication facility, etc., take measures to suppress electric noises.**
It could cause malfunction or break-down due to hazardous effects on the inverter, private power generator, high frequency medical equipment, radio communication equipment, etc.
The influences transmitted from the remote control to medical or communication equipment could disrupt medical activities, video broadcasting or cause noise interference.



• **Do not leave the remote control with its PCB case removed.**
If dew, water, insect, etc. enters through the hole, it could cause electric shocks, fire or break-down.

⚠ CAUTION



- Do not install the wireless kit at the following places in order to avoid malfunction. It could cause break-down or deformation of remote control.

(1) Places exposed to direct sunlight	(8) Places where the receiver is influenced by the fluorescent lamp (especially inverter type) or sunlight
(2) Places near heat devices	(9) Places where the receiver is affected by infrared rays of any other communication devices
(3) High humidity places	(10) Places where some object may obstruct the communication with the remote control
(4) Hot surface or cold surface enough to generate condensation	
(5) Places exposed to oil mist or steam directly	
(6) Uneven surface	
(7) Places affected by the direct air flow of the AC unit	

① Accessories

Please make sure that you have all of the following accessories.

① Receiver		1		① Wireless remote control (RCN-E2)		1
② Wiring (3m)		1		② Remote control holder		1
③ Parts set (A)		1		③ Screw for holder		2
④ Parts set (B)		1		④ AAA dry cell battery (LR03)		2
⑤ Parts set (C)		1		⑤ User's manual		1
⑥ Installation manual		1		① Screw for receiver		2
				② Fixing band		1
				③ Clamp		5
				④ Screw for clamp		5
				① Receiver installation bracket		1
				② Screw for the bracket		2
				③ Installation fitting		2

② Preparation before installation

Setting on site

PCB on the receiver has the following switches to set the function. Default setting is shown with mark.

SW1	Prevents interference during plural setting	ON : Normal	OFF : Customized
SW2	Receiver master/slave setting	ON : Master	OFF : Slave
SW3			
SW4	Auto restart	ON : Valid	OFF : Invalid

② Preparation before installation (continued)

To change setting

1. Remove one screws located on the under of the receiver and detach the board.
2. Change the setting by the switch on PCB.

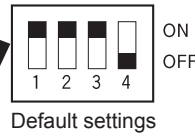
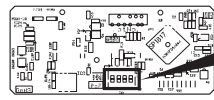
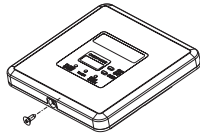

3. When SW1 is turned to OFF position, change the wireless remote control setting. For the method of changing the setting, refer to **Setting to avoid mixed communication** of **④ Wireless remote control**.

*The receivable area of the signal refer to **⑤ Receiver**.

Master/Slave setting when using plural remote controls

Up to two receiver or wired remote control can be installed in one indoor unit group.

When two receiver or wired remote control are used, it is necessary to change SW on the PCB to set it as slave.

③ How to install the receiver

The following two methods can be used to install the receiver onto a ceiling or a wall. Select a method according to the installation position.

- <Installation position>** (A) Direct installation onto the ceiling with wood screws.
(B) Installation with accessory's bracket

(1) Drilling of the ceiling (ceiling opening)

Drill the receiver installation holes with the dimensions shown right at the ceiling position where wires can be connected.

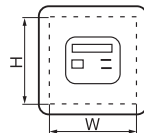

(A) Direct installation onto the ceiling with wood screws.	88mm(H)×101mm(W)
(B) Installation with enclosed bracket	108mm(H)×108mm(W)

(2) Wiring connection of receiver

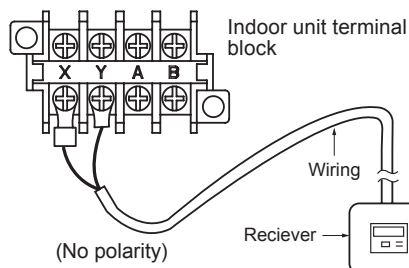

⚠ Caution

Do not connect the wiring to the power source of the terminal block. If it is connected, printed board will be damaged.

(3) Installation of the receiver

Remove the screw on the side of the receiver and split it into the upper case and lower case. Install the receiver with one of the two installation methods (A) to (C) shown below.

(A) Direct installation onto the ceiling with screws

▷ Use this installation method when the ceiling is wooden, and there is no problem for strength in installing directly with wood screws.

- ① Put through the wiring from the back side to the hole of the lower case.
- ② Fit the lower case into the ceiling opening. Make sure that the clearance between the convex part of the back of the lower case and the ceiling opening must be as equal as possible on both sides.
- ③ Using the two installation holes shown right, fix the lower case onto the ceiling with the enclosed wood screws. (The other four holes are not used.)
- ④ Connect the wiring with the wiring from the upper case by the connector.

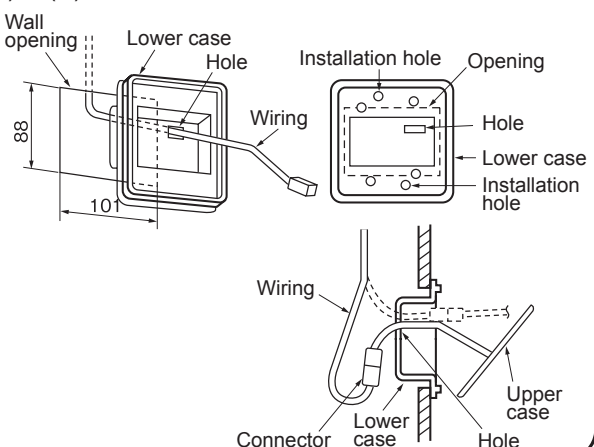

③ How to install the receiver(continued)

- ⑤ Take out the connector to the backside from the hole of the lower case putting through the wiring at ①.
- ⑥ Fit the upper case and the lower case, and tighten the screws.

(B) Installation with enclosed bracket

Use this method when installaing onto a gypsum board (7 to 18mm), etc.

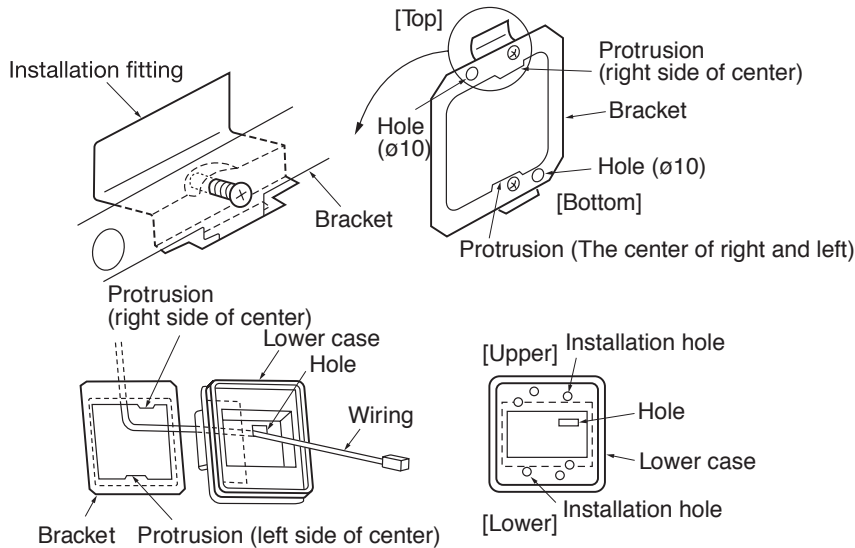

- ① Catch the two protrusion of the enclosed bracket onto the fitting as shown above, and temporarily fix with the screws. (The bracket has an Upper/Lower and front/back orientation. Confirm the Upper/Lower protrusion positions and the positional relation of the ø10 holes on the bracket and the installation hole on the lower case with the above drawing.)
- ② Insert the end of the installation fitting into the back of the ceiling from the opening, and tighten the screws to fix the bracket onto the ceiling.
- ③ Pass the wiring from the rear side through the hole on the lower case.
- ④ Fit the lower case onto the bracket, and fix the lower case to the bracket using the two installation holes shown above. (The other four holes are not used.)
- ⑤ Follow step ① to ⑥ for (A) to complete the installation.

③ How to install the receiver (continued)

(C) Exposed installation

Use the following procedure when installing the case with the wiring exposed.

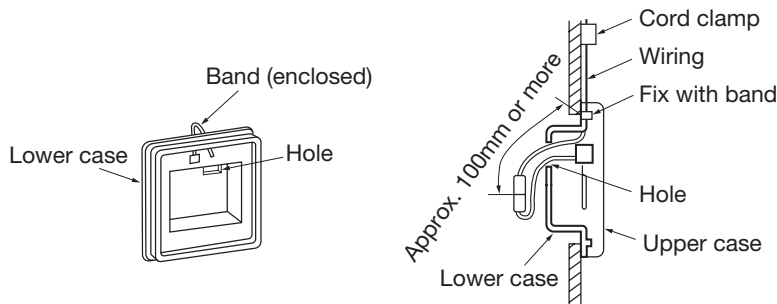

- ① Cut off the thin section on the side of the upper case with a pair of nippers or a knife, and remove the burrs with a file, etc. (The wiring is passed through this section.)
- ② Pass the enclosed band through the wiring outlet hole on the lower case.
- ③ Use one of the light detection adaptor installation methods (A) or (B) explained in section 3, and fix the lower case onto the wall. Do not pass the wiring through the hole on the lower case.
- ④ Fix the wiring using the band while leaving the wiring length from the band fixing section to the end of the wiring connector at 100mm or more.
- ⑤ Connect the wiring with the wiring protruding from the upper case using a connector.
- ⑥ Pass the connected connector and the excess wiring through the hole on the lower case.
- ⑦ Fit the upper case onto the lower case, and tighten the screws.
- ⑧ Adequately fix the wiring with the enclosed cord clamp.

④ Wireless remote control

Installation tips for the remote control holder

Fix the remote control holder using the screws supplied with this product.

* Precautions for installing the holder

- Adjust the position so that it is upright.
- Ensure that the screw heads are not protruding.
- Do not attach the holder on plaster wall.

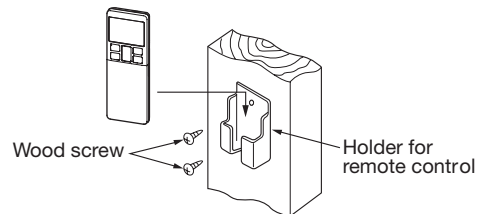

How to insert batteries

1. Detach the back lid.
2. Insert the batteries. (two AAA batteries)
3. Reattach the back lid.

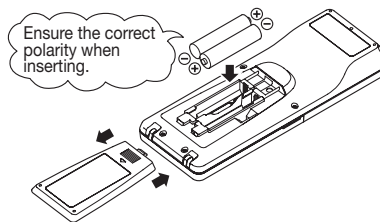

Setting to avoid mixed communication

1. Detach the back lid, and remove the batteries.
2. Cut off the switching wire in the battery compartment using nippers.
3. Insert the batteries, and attach the back lid.

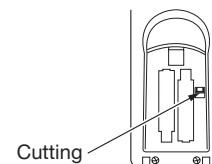

④ Wireless remote control (continued)

Changing the wireless remote control setting

How to change the Auto Run setting

The Auto Run mode is not available on the building air-conditioner and gas heat pump series (excluding the cooling/heating free multi system).

When using the wireless remote control to operate those models, set the wireless remote control to disable the Auto Run mode.

To disable the Auto Run mode, press the **ACL** switch while holding down the **MODE** button, or insert batteries while holding down the **MODE** button.

* Note: Once the batteries are removed, the setting is reset to the factory default. When the batteries are removed, repeat the steps described above.

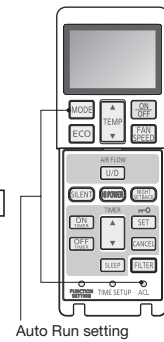

Auto Run setting

Indoor function settings

1. How to set indoor functions

- ① Press the ON/OFF button to stop the unit.
 - ② Press the desired one of the buttons shown below while holding down the FUNCTION SETTING switch.
 - ③ Use the selection buttons, ▲ and ▼, to change the setting.
 - ④ Press the SET button.
- The buzzer on the wireless remote control signal receiver beeps twice, and the LED lamp flashes four times at two-second intervals.

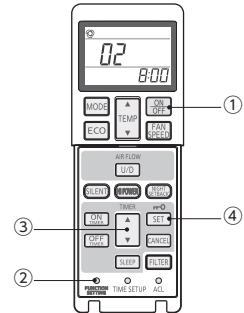

2. Setting details

The following functions can be set.

Button	Number indicator	Function setting	Button	Number indicator	Function setting
FAN SPEED	00	Fun speed setting : Standard	ON TIMER	00	Cooling fan residual-period running : Disable
	01	Fun speed setting : Setting 1 *		01	Cooling fan residual-period running : 0.5 hours
	02	Fun speed setting : Setting 2 *		02	Cooling fan residual-period running : 2 hours
MODE	00	Room heating temperature adjustment : Disable	OFF TIMER	03	Cooling fan residual-period running : 6 hours
	01	Room heating temperature adjustment : +1°C		00	Heating fan residual-period running : Disable
	02	Room heating temperature adjustment : +2°C		01	Heating fan residual-period running : 0.5 hours
	03	Room heating temperature adjustment : +3°C		02	Heating fan residual-period running : 2 hours
FILTER	00	Filter sign display : OFF	NIGHT SETBACK	03	Heating fan residual-period running : 6 hours
	01	Filter sign display : 180 hours		00	Remote control signal receiver LED : Brightness High
	02	Filter sign display : 600 hours		01	Remote control signal receiver LED : Brightness Low
	03	Filter sign display : 1000 hours		02	Remote control signal receiver LED : OFF
U/P	04	Filter sign display : Operation stop after 1000 hours have elapsed	* Refer to service manual.		
	00	Anti draft setting : Disable			
SILENT	01	Anti draft setting : Enable			
	00	Infrared sensor setting (Motion sensor setting) : Disable			
HI POWER	01	Infrared sensor setting (Motion sensor setting) : Enable			
	00	Infrared sensor control (Motion sensor control) : Disable			
	01	Infrared sensor control (Motion sensor control) : Power control only			
	02	Infrared sensor control (Motion sensor control) : Auto OFF only			
	03	Infrared sensor control (Motion sensor control) : Power control and Auto OFF			

⑤ Receiver

1 Control plural indoor units with one remote control

Up to 16 indoor units can be connected.

1. Connect the XY terminal with 2 cores wire. As for the size, refer to the following note.
2. For Packaged air-conditioner series, set the indoor unit address with SW2 on the indoor unit PCB from [0] to [F] so as not to duplicate.

Restrictions on the thickness and length of wire (Maximun total extension 600m.)

Standard	Within	Thickness	Length
	0.3 mm ²	× 100m	
	0.5 mm ²	× 200m	
	0.75mm ²	× 300m	
	1.25mm ²	× 400m	
	2.0 mm ²	× 600m	

⑤ Receiver (continued)

For the shop series

For VRF series, set the indoor unit address with SW1, SW2 and SW5-2 on the indoor unit PCB from [000] to [127] so as not to duplicate.

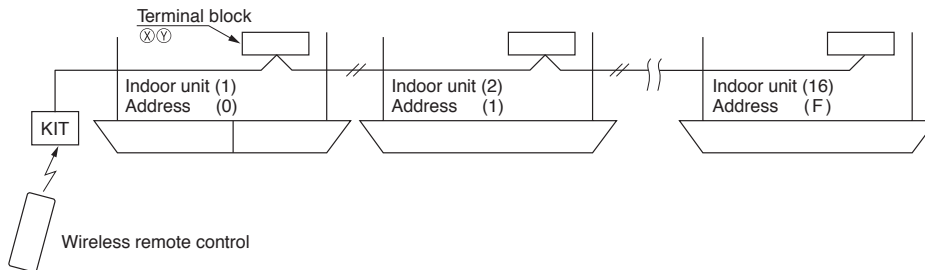

For the building air-conditioner and gas heat pump series

Set the indoor unit and outdoor unit numbers by manually specifying the addresses. Use the rotary switches SW1 and SW2 provided on the indoor unit PCB (printed circuit board) to set the indoor unit numbers so that they are not duplicated.

Master/Slave setting when using plural remote control

Up to two receivers can be installed in one indoor unit group.

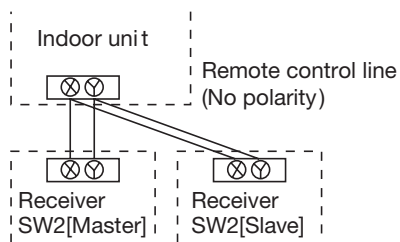

Switch	Setting	Function
SW2	ON	Master
	OFF	Slave

When installed on ceiling

1. Standard reachable area of the signal

[Condition] Illuminance at the receiver : **300lux** (when no lighting is installed within 1m of the receiver in an ordinary office.)

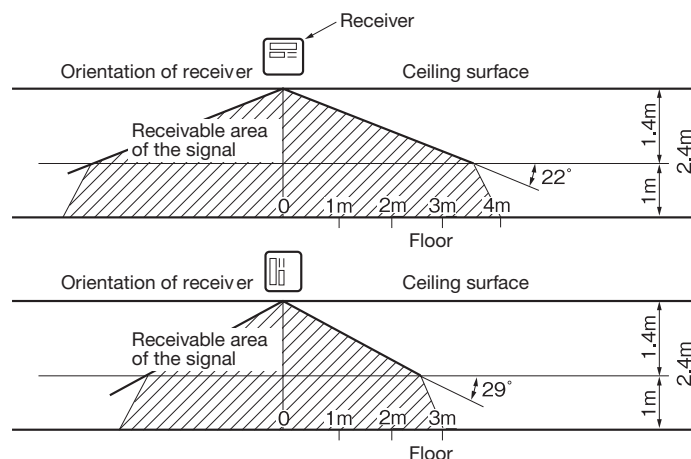

2. Correlation between illuminance at the receiver and reachable area of the signal in a plain view.

[Condition] Correlation between the reachable area of the signal and illuminance at the receiver when the wireless remote control is operated at 1m high under the condition of ceiling height of 2.4m. When the illuminance becomes double, the area is narrowed down to two third.

⑤ Receiver (continued)

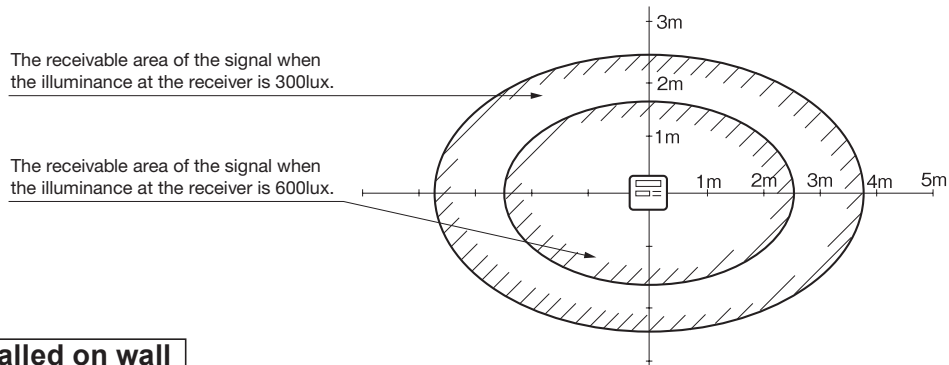

When installed on wall

[Condition] Illuminance at the receiver : 800lux.

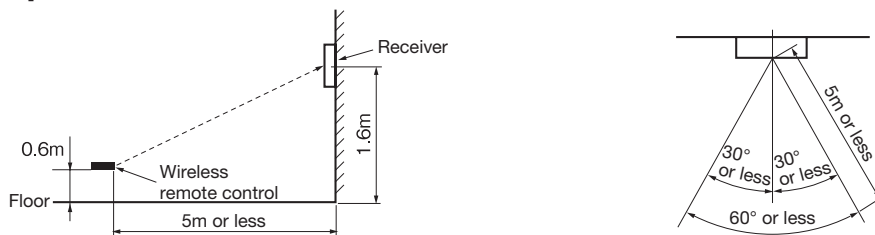

Backup switch

A backup switch is provided on the receiver section of the panel surface. When operation from the wireless remote control unit is not possible (due to flat batteries, a mislaid unit, a unit failure), you can use it as an emergency means. You should operate this switch manually.

1. If pressed while the air-conditioner is in a halt, it will cause the air-conditioner to start operation in the automatic mode (in the case of cooling only, in the cooling mode). Wind speed: Hi fan, Temperature setting: 23°C, Louver: horizontal
2. If pressed while the air-conditioner is in operation, it will stop the air-conditioner.

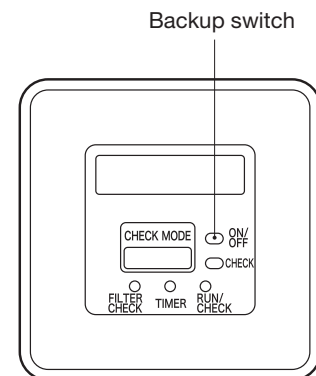

Cooling test run operation

- After safety confirmation, turn on the power.
- Transmit a cooling operation command with the wireless remote control unit, while the backup switch on the receiver is depressed.
- If the backup switch on the receiver is pressed during a test run, it will end the test run.
- If you cannot operate the unit properly during a test run, please check wiring by consulting with inspection guides.

How to read the 6-digit display

A 6-digit indicator (7-segment indicator) is provided on the receiver section.

1. An indication will be displayed for one hour after power on.
2. An indication appears for 3.5 seconds when a "Stop" command is sent from the wireless remote control unit while the air-conditioner is not running.
3. An indication appearing in (1) or (2) above will go off as soon as the unit starts operation.
4. When there are no error records to indicate, addresses are displayed for all of the connected units.
5. When there are some error records remaining, the error records are displayed.
6. Error records can be cleared by transmitting a "Stop" command from the wireless remote control unit, while the backup switch is depressed.

3.1.4 FDE series (RCN-E-E3)

Safety precautions

• Please read this manual carefully before starting installation work to install the unit properly. Every one of the followings is important information to be observed strictly.

 **WARNING** Failure to follow these instructions properly may result in serious consequences such as death, severe injury, etc.

 **CAUTION** Failure to follow these instructions properly may cause injury or property damage. It could have serious consequences depending on the circumstances.

• The following pictograms are used in the text.



Never do.



Always follow the instructions given.

• Keep this manual at a safe place where you can consult with whenever necessary. Show this manual to installers when moving or repairing the unit. When the ownership of the unit is transferred, this manual should be given to a new owner.

WARNING



• **Consult your dealer or a professional contractor to install the unit.**
Improper installation made on your own may cause electric shocks, fire or dropping of the unit.



• **Installation work should be performed properly according to this installation manual.**
Improper installation work may result in electric shocks, fire or break-down.



• **Be sure to use accessories and specified parts for installation work.**
Use of unspecified parts may result in drop, fire or electric shocks.



• **Install the unit properly to a place with sufficient strength to hold the weight.**
If the place is not strong enough, the unit may drop and cause injury.



• **Be sure to have the electrical wiring work done by qualified electrical installer, and use exclusive circuit.**
Power source with insufficient and improper work can cause electric shock and fire.



• **Shut OFF the main power source before starting electrical work.**
Otherwise, it could result in electric shocks, break-down or malfunction.



• **Do not modify the unit.**
It could cause electric shocks, fire, or break-down.



• **Be sure to turn OFF the power circuit breaker before repairing/inspecting the unit.**
Repairing/inspecting the unit with the power circuit breaker turned ON could cause electric shocks or injury.



• **Do not install the unit in appropriate environment or where inflammable gas could generate, flow in, accumulate or leak.**
If the unit is used at places where air contains dense oil mist, steam, organic solvent vapor, corrosive gas (ammonium, sulfuric compound, acid, etc) or where acidic or alkaline solution, special spray, etc. are used, it could cause electric shocks, break-down, smoke or fire as a result of significant deterioration of its performance or corrosion.



• **Do not install the unit where water vapor is generated excessively or condensation occurs.**
It could cause electric shocks, fire, or break-down.







• **Do not use the unit in a place where it gets wet, such as laundry room.**
It could cause electric shocks, fire, or break-down.



• **Do not operate the unit with wet hands.**
It could cause electric shocks.

⚠ WARNING

-  • **Do not wash the unit with water.**
It could cause electric shocks, fire, or break-down.
-  • **Use the specified cables for wiring, and connect them securely with care to protect electronic parts from external forces.**
Improper connections or fixing could cause heat generation, fire, etc.
-  • **When installing the unit at a hospital, telecommunication facility, etc., take measures to suppress electric noises.**
It could cause malfunction or break-down due to hazardous effects on the inverter, private power generator, high frequency medical equipment, radio communication equipment, etc.
The influences transmitted from the remote control to medical or communication equipment could disrupt medical activities, video broadcasting or cause noise interference.
-  • **Do not leave the remote control with its PCB case removed.**
If dew, water, insect, etc. enters through the hole, it could cause electric shocks, fire or break-down.



⚠ CAUTION

-  • **Do not install the wireless kit at the following places in order to avoid malfunction.**
It could cause break-down or deformation of remote control.

(1) Places exposed to direct sunlight	(8) Places where the receiver is influenced by the fluorescent lamp (especially inverter type) or sunlight.
(2) Places near heat devices	(9) Places where the receiver is affected by infrared rays of any other communication devices.
(3) High humidity places	(10) Places where some object may obstruct the communication with the remote control
(4) Hot surface or cold surface enough to generate condensation	
(5) Places exposed to oil mist or steam directly	
(6) Uneven surface	
(7) Places affected by the direct air flow of the AC unit.	

① Accessories

Please make sure that you have all of the following accessories.

① Receiver		1			
② Parts set		1	→	① Wireless remote control (RCN-E2)	1
③ Installation manual		1		② Remote control holder	1
④ Wiring		1		③ Screw for holder	2
				④ AAA dry cell battery (LR03)	2
				⑤ User's manual	1

② Preparation before installation

Setting on site

PCB on the receiver has the following switches to set the function.
Default setting is shown with mark.

SW1	Prevents interference during plural setting	ON : <input type="checkbox"/> Normal OFF : <input type="checkbox"/> Customized
SW2	Receiver master/slave setting	ON : <input type="checkbox"/> Master OFF : <input type="checkbox"/> Slave
SW3	Buzzer	ON : <input type="checkbox"/> Valid OFF : <input type="checkbox"/> Invalid
SW4	Auto restart	ON : <input type="checkbox"/> Valid OFF : <input type="checkbox"/> Invalid

② Preparation before installation (continued)

To change setting

1. Remove four screws located on the back of the receiver and detach the board.
2. Change the setting by the switch on PCB.

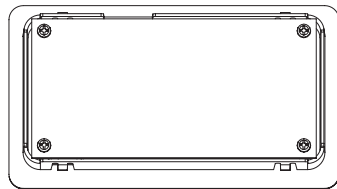

Receiver backside

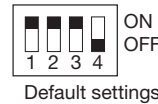
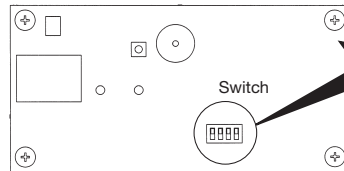

Default settings

Master/Slave setting when using plural remote controls

Up to two receiver or wired remote control can be installed in one indoor unit group. When two receiver or wired remote control are used, it is necessary to change SW on the PCB to set it as slave.

3. When SW1 is turned to OFF position, change the wireless remote control setting. For the method of changing the setting, refer to **Setting to avoid mixed communication** of

⑤ Wireless remote control

*The receivable area of the signal refer to **⑥ Receiver**.

③ How to install the receiver

The receiver can be installed by replacing with a cover of the panel.

CAUTION: When installing the receiver after unit has been fixed, injury due to falling may result because of working at high place.

- ① **Remove the cover**
Insert a flat-blade screwdriver into the dented part (2 places), and wrench slightly so as not to damage panel surface.
- ② **Connect the wiring**
Connect wiring of the receiver to the wiring in the back.

ATTENTION: Do not remove the clamp fixed the wiring.

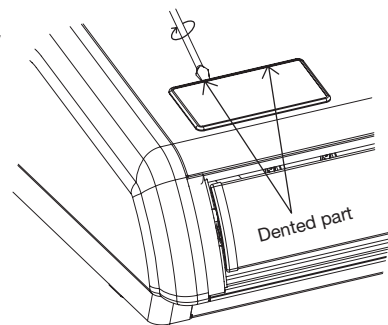
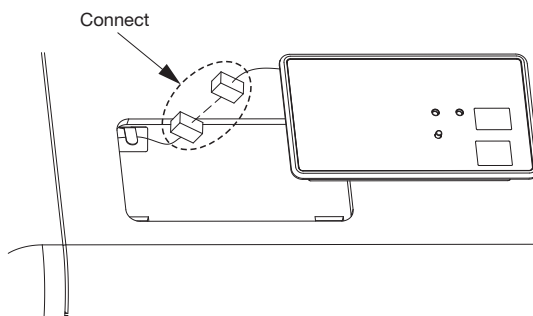

Place the connectors under the panel

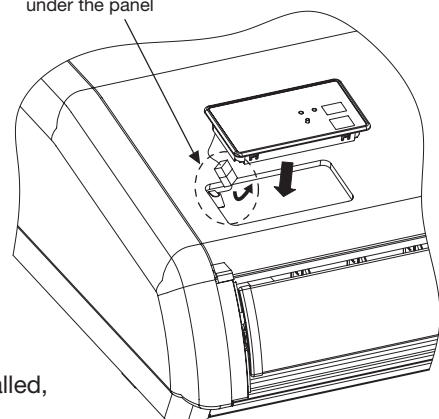

- ③ **Installation of the receiver**
Check direction of the receiver, and fix to the panel.

CAUTION: Connect the connectors before installing the receiver. In case of connecting after the receiver had been installed, it will be necessary to remove the panel.

④ How to connect the wiring for control box

Connect the attached wiring to the signal terminal block primary side XY (for grill side) in the control box, and connect to the CNL connector (3P white) from the receiver .

* This installation is unnecessary for indoor unit that have wiring is already connected from the signal terminal block to the receiver.

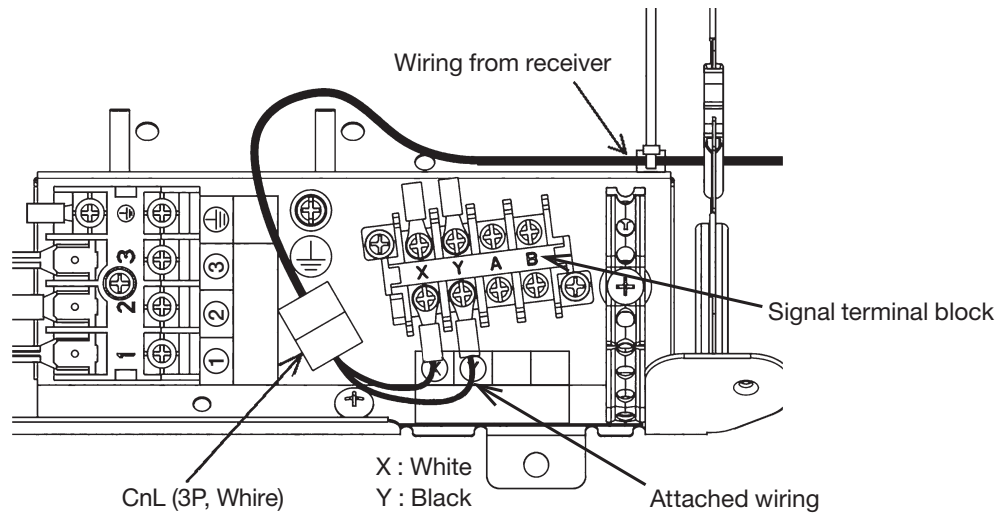

5 Wireless remote control

Installation tips for the remote control holder

Fix the remote control holder using the screws supplied with this product.

* Precautions for installing the holder

- Adjust the position so that it is upright.
- Ensure that the screw heads are not protruding.
- Do not attach the holder on plaster wall.

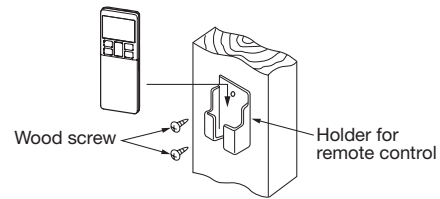

How to insert batteries

1. Detach the back lid.
2. Insert the batteries. (two AAA batteries)
3. Reattach the back lid.

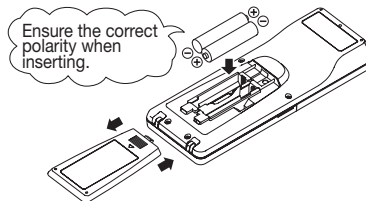

Setting to avoid mixed communication

1. Detach the back lid, and remove the batteries.
2. Cut off the switching wire in the battery compartment using nippers.
3. Insert the batteries, and attach the back lid.

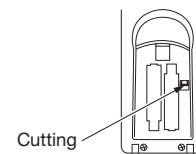

Changing the remote control setting

How to change the Auto Run setting

The Auto Run mode is not available on the building air conditioning and gas heat pump series (excluding the cooling/heating free multi system).

When using the remote control to operate those models, set the remote control to disable the Auto Run mode.

To disable the Auto Run mode, press the **[ACL]** switch while holding down the **[MODE]** button, or insert batteries while holding down the **[MODE]** button.

* Note: Once the batteries are removed, the setting is reset to the factory default. When the batteries are removed, repeat the steps described above.

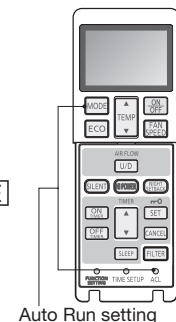

Auto Run setting

Indoor function settings

1. How to set indoor functions

- ① Press the ON/OFF button to stop the unit.
- ② Press the desired one of the buttons shown item 2. while holding down the FUNCTION SETTING switch.
- ③ Use the selection buttons, ▲ and ▼, to change the setting.
- ④ Press the SET button.

The buzzer on the remote control signal receiver beeps twice, and the LED lamp flashes four times at two-second intervals.

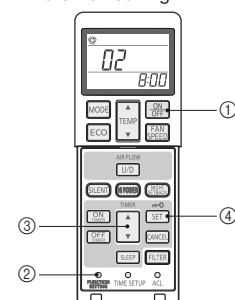

⑤ Wireless remote control (continued)

2. Setting details

The following functions can be set.

Button	Number indicator	Function setting
FAN SPEED	00	Fan speed setting : Standard
	01	Fan speed setting : Setting 1 *
	02	Fan speed setting : Setting 2 *
MODE	00	Room heating temperature adjustment : Disable
	01	Room heating temperature adjustment : +1°C
	02	Room heating temperature adjustment : +2°C
	03	Room heating temperature adjustment : +3°C
FILTER	00	Filter sign display : OFF
	01	Filter sign display : 180 hours
	02	Filter sign display : 600 hours
	03	Filter sign display : 1000 hours
	04	Filter sign display : Operation stop after 1000 hours have elapsed
U/P (Up/Down)	00	Anti draft setting : Disable
	01	Anti draft setting : Enable
SILENT	00	Infrared sensor setting (Motion sensor setting) : Disable
	01	Infrared sensor setting (Motion sensor setting) : Enable
HI POWER	00	Infrared sensor control (Motion sensor control) : Disable
	01	Infrared sensor control (Motion sensor control) : Power control only
	02	Infrared sensor control (Motion sensor control) : Auto OFF only
	03	Infrared sensor control (Motion sensor control) : Power control + Auto OFF
ON TIMER	00	Cooling fan residual-period running : Disable
	01	Cooling fan residual-period running : 0.5 hours
	02	Cooling fan residual-period running : 2 hours
	03	Cooling fan residual-period running : 6 hours
OFF TIMER	00	Heating fan residual-period running : Disable
	01	Heating fan residual-period running : 0.5 hours
	02	Heating fan residual-period running : 2 hours
	03	Heating fan residual-period running : 6 hours
NIGHT SETBACK	00	Remote control signal receiver LED : Brightness High
	01	Remote control signal receiver LED : Brightness Low
	02	Remote control signal receiver LED : OFF

* Refer to service manual.

⑥ Receiver

1 Control plural indoor units with one remote control

Up to 16 indoor units can be connected.

1. Connect the XY terminal with 2 cores wire. As for the size, refer to the following note.
2. For Packaged air conditioner series, set the indoor unit address with SW2 on the indoor unit PCB from [1] to [F] so as not to duplicate.

Restrictions on the thickness and length of wire (Maximun total extension 600m.)

Standard	Within	0.3 mm ² × 100m
	Within	0.5 mm ² × 200m
	Within	0.75mm ² × 300m
	Within	1.25mm ² × 400m
	Within	2.0 mm ² × 600m

For the shop series

For VRF series, set the indoor unit address with SW1, SW2 and SW5-2 on the indoor unit PCB from [000] to [127] so as not to duplicate.

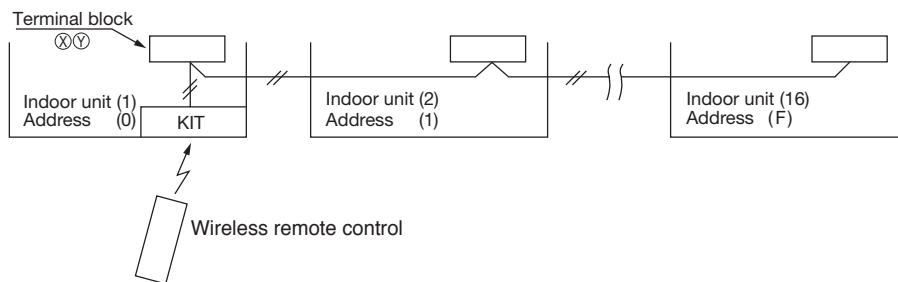

For the building air-conditioning and gas heat pump series

Set the indoor unit and outdoor unit numbers by manually specifying the addresses.

Use the rotary switches SW1 and SW2 provided on the indoor unit PCB (printed circuit board) to set the indoor unit numbers so that they are not duplicated.

Master/Slave setting when using plural remote control

Up to two receivers can be installed in one indoor unit group.

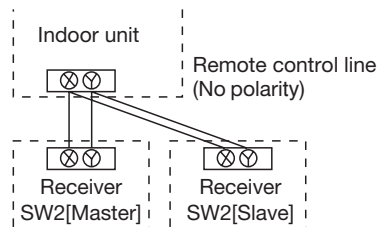

Switch	Setting	Function
SW2	ON	Master
	OFF	Slave

⑥ Receiver (continued)

Wireless remote control's operable area

1. Standard signal receiving range

[Condition]

Illuminance at the receiver area: 300 lux.

(When no lighting fixture is located within 1 m of indoor unit in an ordinary office)

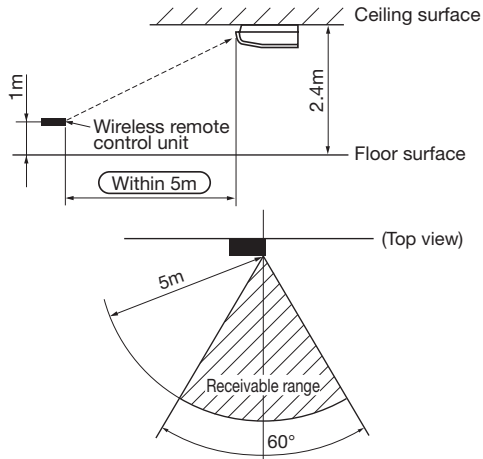

2. Points for attention in connecting a plural number of indoor units

[Condition]

Illuminance at the receiver area: 300 lux.

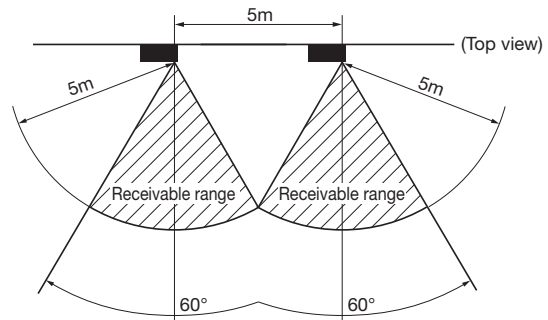

Backup switch

A backup switch is provided on the receiver section of the panel surface.

When operation from the wireless remote control unit is not possible (due to flat batteries, a mislaid unit, a unit failure), you can use it as an emergency means. You should operate this switch manually.

1. If pressed while the air-conditioner is in a halt, it will cause the air-conditioner to start operation in the automatic mode (in the case of cooling only, in the cooling mode).
Wind speed: Hi fan, Temperature setting: 23°C, Louver: horizontal.
2. If pressed while the air-conditioner is in operation, it will stop the air-conditioner.

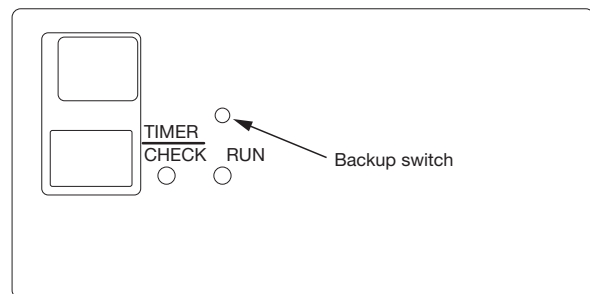

Cooling test run operation

- After safety confirmation, turn on the power.
- Transmit a cooling operation command with the wireless remote control unit, while the backup switch on the receiver is depressed.
- If the backup switch on the receiver is pressed during a test run, it will end the test run.
- If you cannot operate the unit properly during a test run, please check wiring by consulting with inspection guides.

How to read the two-digit display

A two-digit indicator (7-segment indicator) is provided on the receiver section.



1. An indication will be displayed for one hour after power on.
2. An indication appears for 3.5 seconds when a "Stop" command is sent from the wireless remote control unit while the air-conditioner is not running.
3. An indication appearing in (1) or (2) above will go off as soon as the unit starts operation.
4. When there are no error records to indicate, addresses are displayed for all of the connected units.
5. When there are some error records remaining, the error records are displayed.
6. Error records can be cleared by transmitting a "Stop" command from the wireless remote control unit, while the backup switch is depressed.

3.2 MOTION SENSOR KIT

3.2.1 FDT series (LB-T-5W-E)

PJF012D036 



WARNING

- Connect the wiring to the PCB in the control box on the indoor unit and hold the wiring securely so as not to apply unexpected stress on the PCB.
Loose connection or hold will cause abnormal heat generation or fire. 
- Make sure the power source is turned off when electric wiring work.
Otherwise, electric shock, malfunction and improper running may occur. 

CAUTION

- Do not install the motion sensor kit at the following places in order to avoid malfunction.

(1) Places exposed to direct sunlight (2) Places near heat devices (3) High humidity places (4) Hot surface or cold surface enough to generate condensation (5) Places exposed to oil mist or steam directly (6) Places affected by the direct air flow of the Indoor unit	(7) Places where the motion sensor is influenced by the fluorescent lamp or sunlight (8) Places where the motion sensor is affected by infrared rays of any other communication devices (9) Places where some object may obstruct the motion sensor
---	---



- Do not leave the motion sensor without the cover.
In case the cover needs to be detached, protect the motion sensor with a packaging or bag.
In order to keep it away from water and dust. 

Attention

- Instruct the customer how to operate it correctly referring to the instruction manual.
- For the installation method of the air-conditioner itself, refer to the installation manual enclosed in the package.

① Accessories

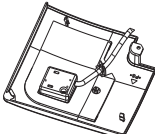
Please make sure that you have the motion sensor.

Motion sensor		1
---------------	---	---

② Installing the motion sensor

It is possible to install the motion sensor by replacing with a corner lid on the panel.

Aim of the detectable scope

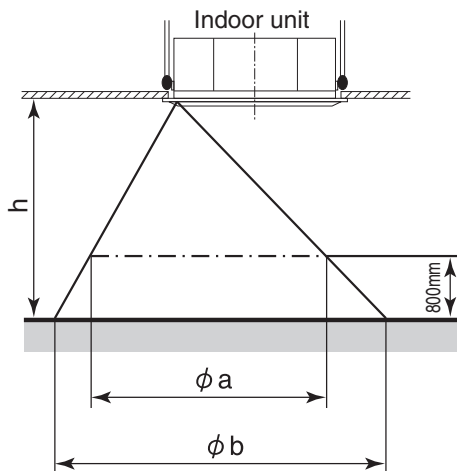

Hight of the ceiling	h[m]	2.7	3.5	4.0
Detectable scope①	φ a[m]	about 4.5	about 6.4	about 7.6
Detectable scope②	φ b[m]	about 6.4	about 8.3	about 9.5

Preparation before installation

- ① Install the panel onto the indoor unit according to the installation manual for the panel.
- ② Remove the inlet grille.
- ③ Remove the corner lid (A) located on the panel.
- ④ Loosen 2 screws for the control lid. (It is unnecessary to remove the screws.)
- ⑤ Slide the control lid, and open and remove it.

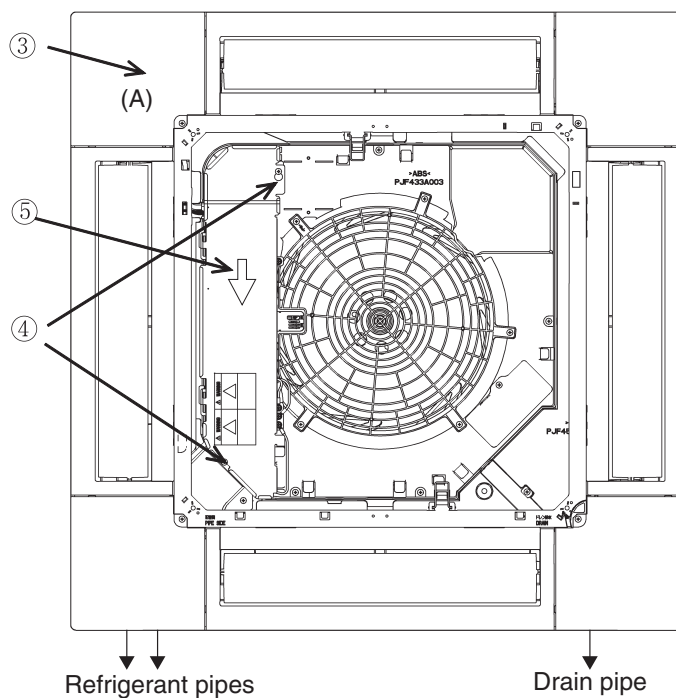

Installation of the motion sensor

- ① Loosen the bolts which fix the panel, and make a gap between the panel and the indoor unit.
- ② Pass the wiring of the motion sensor through the opening of the panel.
- ③ Hang the wiring on the hook which is on the panel's inside.
- ④ Pass the wiring through the opening of the control box.
- ⑤ Connect the connector to CNL(3P,Black) on PWB in the control box.
- ⑥ Tighten the bolts which fix the panel.
- ⑦ Install the motion sensor on the panel.
- ⑧ Fix the motion sensor by the screw.
- ⑨ Reinstall the control lid, and tighten 2 screws.

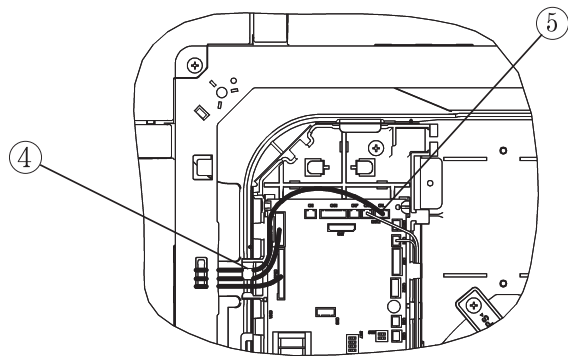
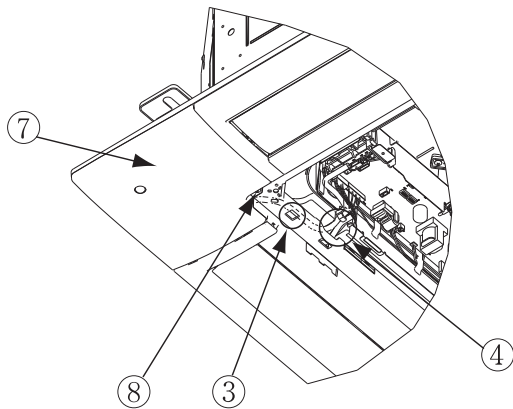
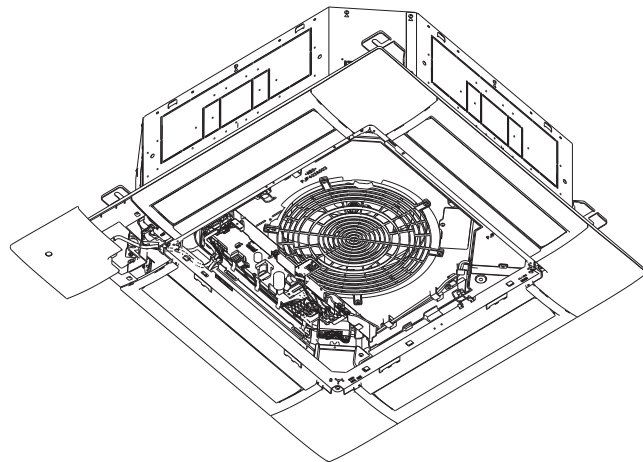
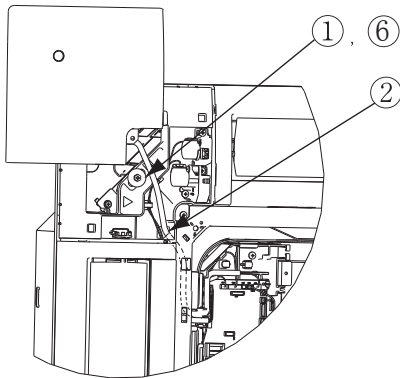

③ Setting the motion sensor

The motion sensor will not function if it is only installed.

Set the function of the motion sensor by the wired or wireless remote control.

Refer to the manual instruction of each remote control for the setting procedure.

Note: It is not possible to set by the following remote control models or older.

Wired: RC-EX1A, RC-E5, RCH-E3

Wireless: RCN-E1R

PJF012D504

3.2.2 FDTC series (LB-TC-5W-E)

⚠ WARNING

- Connect the wiring to the PCB in the control box on the indoor unit and fix the wiring securely so as not to apply unexpected stress on the PCB. Loose connection or fixing will cause abnormal heat generation or fire. ⚠
- Make sure the power source is turned off during electrical wiring work. Otherwise, electric shock, malfunction and abnormal operation may occur. ⚠

⚠ CAUTION

- Do not install the motion sensor kit at the following places in order to avoid malfunction.

<ul style="list-style-type: none"> (1) Places exposed to direct sunlight (2) Places near heat-generating devices (3) High humidity places (4) Hot surface or cold surface enough to generate condensation (5) Places directly exposed to oil mist or steam (6) Places affected by the direct air flow of the indoor unit (7) Places where the motion sensor may be influenced by fluorescent lamp or sunlight 	<ul style="list-style-type: none"> (8) Places where the motion sensor may be affected by infrared rays of any other communication devices (9) Places where some object may obstruct the motion sensor (10) Places where there may be impact on the motion sensor (11) Places with strong radio wave or static electricity (12) Dusty place where the motion sensor lens may become tainted or be damaged
--	---

⊘
- Do not leave the motion sensor without the cover. In case the cover needs to be detached, protect the motion sensor with a packaging or bag in order to keep it away from water and dust. ⊘

Attention

- Instruct the customer how to operate the motion sensor kit correctly by referring to the instruction manual.
- For the installation method of the air-conditioner itself, refer to the installation manual enclosed in the package.

① Accessories

Please make sure that all components are in the package.

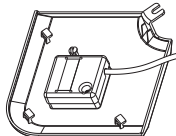
Motion sensor		1
---------------	---	---

② Installing the motion sensor

It is possible to install the motion sensor by replacing the corner lid on the panel.

The detectable area

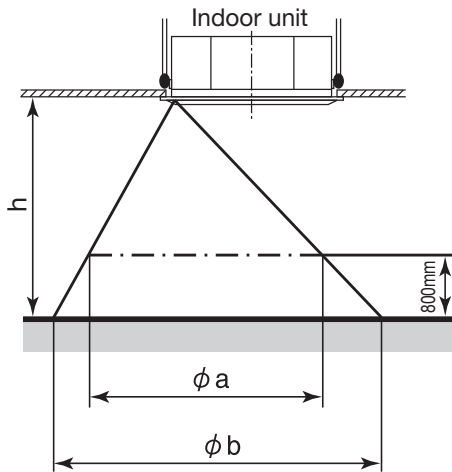

Height of the ceiling	h[m]	2.7	3.5	4.0
Detectable area①	φ a[m]	about 4.5	about 6.4	about 7.6
Detectable area②	φ b[m]	about 6.4	about 8.3	about 9.5

Preparation before installation

- ① Remove the inlet grille according to the installation manual of the panel.
- ② Remove the corner lid at the drain pipe side.
- ③ Loosen screws (2 pcs) on the control box of the unit. (It is not necessary to remove the screws.)
- ④ Slide the control lid in the arrow direction, and remove it.

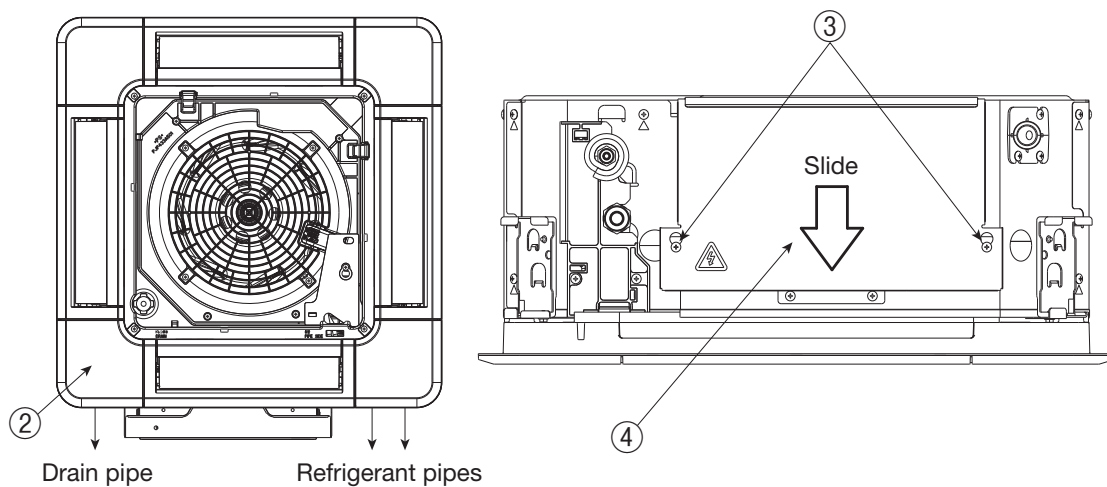

Installation of the motion sensor

- ① Cut the half blanking (4 sections) of the panel as shown in the following figure.
- ② Pass the motion sensor wiring through the opening of the panel.
- ③ Connect the wiring connector to CNL (3P, black) on the PCB in the control box.
- ④ Fix the wiring with a band as shown below.
- ⑤ Install the motion sensor on the panel according to the installation manual of the panel.
- ⑥ Install the control lid with care not to pinch the wiring, and reinstall the control lid with screws (2 pcs.).

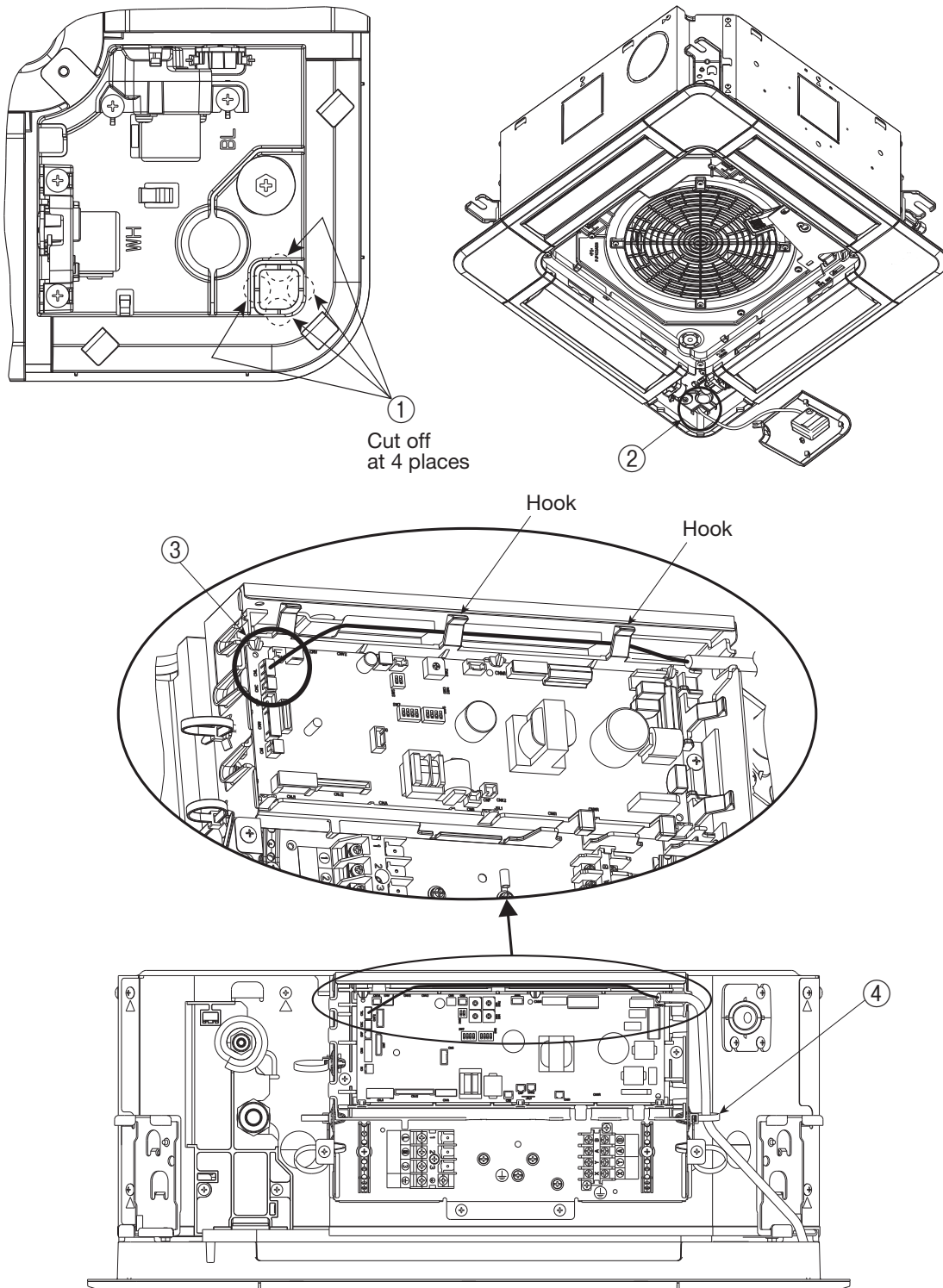

③ Setting the motion sensor



The motion sensor will not function if it is only installed.
Set the function of the motion sensor by the wired or wireless remote control.
Refer to the manual instruction of each remote control for the setting procedure.

Note: It is not possible to set by the following remote control models or older ones.
Wired: RC-EX1A, RC-E5, RCH-E3
Wireless: RCN-E1R

PJZ012D122 

3.2.3 FDU, FDUM series (LB-KIT)

WARNING

- Connect the wiring to the PCB in the control box on the indoor unit and hold the wiring securely so as not to apply unexpected stress on the PCB. Loose connection or hold will cause abnormal heat generation or fire. 
- Make sure the power source is turned off when electric wiring work. Otherwise, electric shock, malfunction and improper running may occur. 

CAUTION

- Do not install the motion sensor kit at the following places in order to avoid malfunction.





<ul style="list-style-type: none"> (1) Places exposed to direct sunlight (2) Places near heat devices (3) High humidity places (4) Hot surface or cold surface enough to generate condensation (5) Places exposed to oil mist or steam directly (6) Places affected by the direct air flow of the Indoor unit (7) Places where the motion sensor is influenced by the fluorescent lamp or sunlight 	<ul style="list-style-type: none"> (8) Places where the motion sensor is affected by infrared rays of any other communication devices (9) Places where some object may obstruct the motion sensor (10) Place that the motion sensor have a shock (11) Place with the strong radio wave or Static electricity (12) Place that motion sensor lens become tainted or have damaged. Dusty place (13) Place where it runs in parallel with strong voltage lines such as power source wiring
---	--
- Do not leave the motion sensor without the cover. In case the cover needs to be detached, protect the motion sensor with a packaging or bag. In order to keep it away from water and dust. 

Attention

- This manual describes how to install the motion sensor kit.
- Instruct the customer how to operate it correctly referring to the instruction manual.
- For the installation method of the air-conditioner itself, refer to the installation manual enclosed in the package.

Accessories

Please make sure that all components are in the package.

Motion sensor	Wiring <1>	Wiring <2>	2 screws	Manual
	In case of CnL connector on the indoor unit PCB (FDT/FDK/FDTC) 	In case of CnL connector is not on the indoor unit PCB 		

※ Please prepare a relay wiring for connecting the motion sensor and indoor unit on site. (0.2 mm² or thicker, triplex (red, white and black) cable for communication, with the maximum length of 8 m.)

② Installing the motion sensor

- The recommended height is lower than 4000 mm for motion sensor. When the installation height is higher, motion detection accuracy might be reduced.
- Sensor will detect the object with a different temperature from the surrounding.
- Motion sensor is more sensitive to motions in the direction of ⇄ mark.
- Sensor may not detect small children or infants with little motion.
- Although motion sensor can be installed on a wall, it is recommended to install it on the ceiling plane.
- If the sensor is installed on the wall, the sensing distance in the front direction is about 5 m, covering the angle of about 100 degrees.

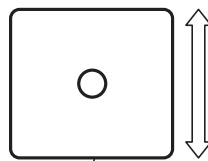

Side of screws for fixing the case

The detectable area

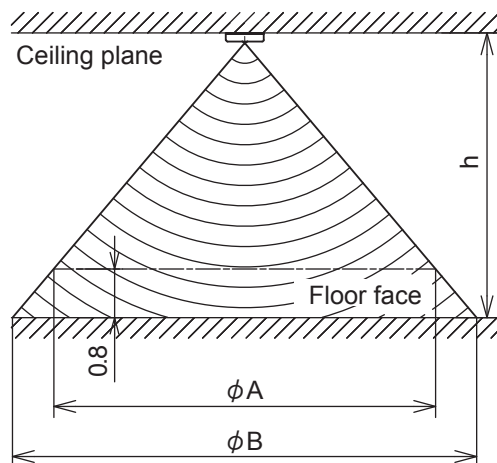

Height of the ceiling	h (m)	2.7	3.5	4.0
Detectable area	ϕA (m)	4.5	6.4	7.6
Detectable area	ϕB (m)	6.4	8.3	9.5

Installing the motion sensor

There are the following 3 methods to install the motion sensor on the ceiling plane or wall surface (hereinafter called "ceiling plane"). Select the method according to the installation position.

<How to install>

- Direct installation by screws to the ceiling plane with the wiring in the ceiling space.
- Direct installation by screws to the ceiling plane with the wiring in the room.
- Installation with switch box (prepare at the site)

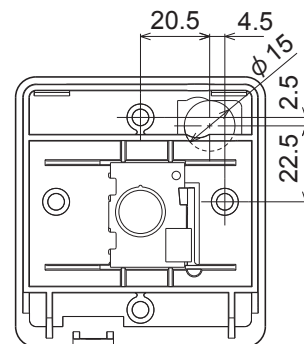

Positional relation for pulling out relay wiring hole and installing holes.

Option (A)

►Select this method if the ceiling plane has sufficient strength to install the motion sensor directly with screws.

- ① Prepare a relay wiring on site and lay out the wiring in advance.
- ② Remove the screw at the side of the motion sensor and slide the upper case in the direction of the arrow.
- ③ Pull the wiring of the motion sensor as below.

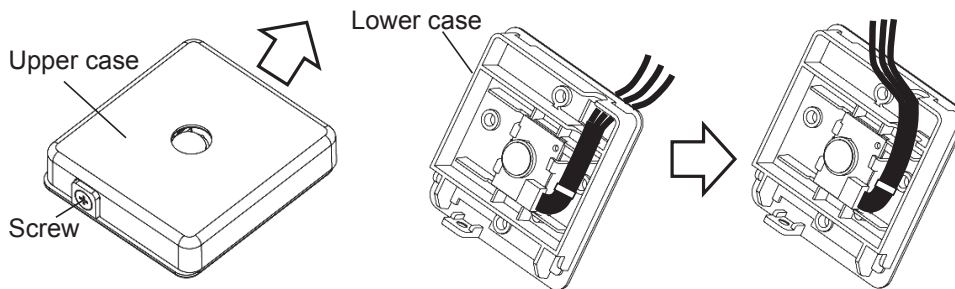
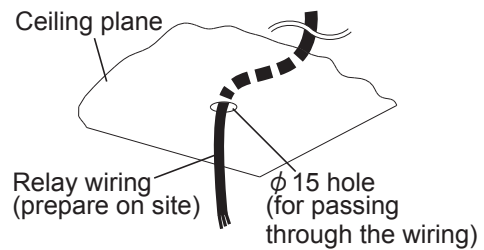

- ④ Pass the relay wiring through the hole on the lower case.
- ⑤ When fixing the lower case to the ceiling plane, tighten it in 2 locations of the installing holes (4 locations) with the attached screws.

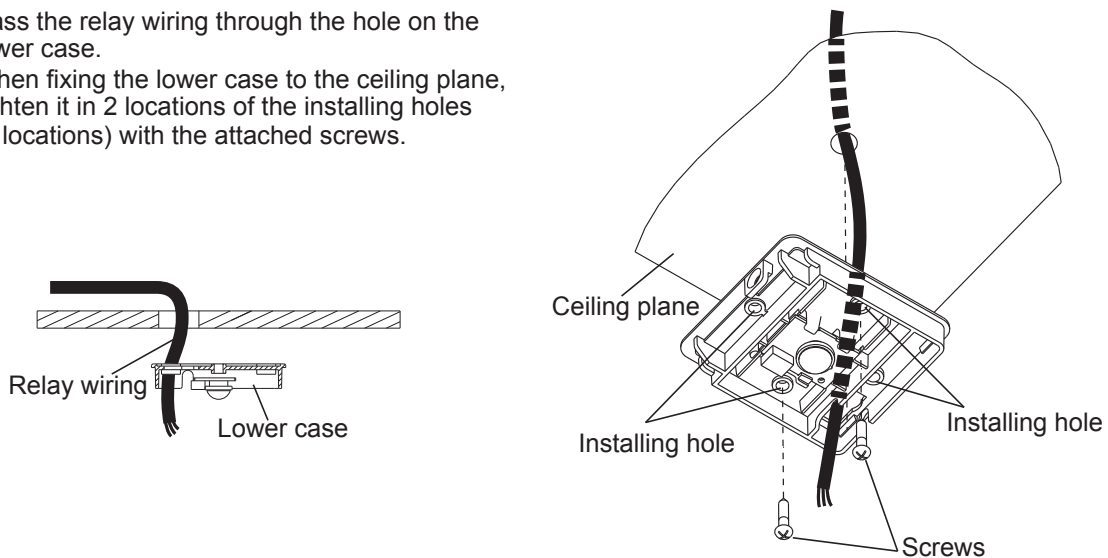

- ⑥ Using a crimping terminal, etc., connect the same color to the relay wiring (prepare on site) and the wiring of motion sensor.



- ⑦ Place the connecting part inside of the ceiling space.
- ⑧ Seal the wiring hole on the lower case with putty.
- ⑨ Taking care not to pinch the wirings, slip the upper case into the lower case, and tighten the screws.

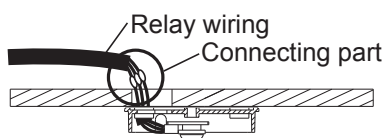

Caution:
In order to prevent tracking, be sure to perform construction so as not to clog up the connecting part with dust, etc.

Option (B)

► Select this method if the ceiling plane has sufficient strength to install the motion sensor directly with screws.

- ① Remove the screw at the side of the motion sensor and slide the upper case in the direction of the arrow.
(The same as ② of Option (A))
- ② Pull the wiring of the motion sensor toward the side. Cut off the thinner part of the upper case.

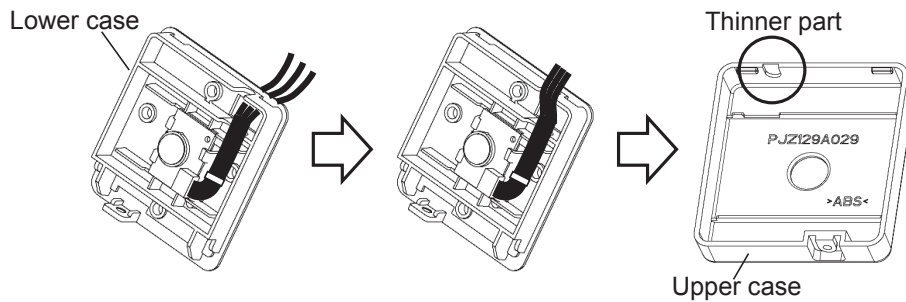

- ③ When fixing the lower case to the ceiling plane, tighten it in 2 locations of the installing holes (4 locations) with the attached screws. (The same as ⑤ of Option (A))
- ④ Using a crimping terminal, etc., connect the same color to the relay wiring (prepare on site) and the wiring of motion sensor.
(The same as ⑥ of Option (A))
- ⑤ Taking care not to pinch the wirings, slip the upper case into the lower case, and tighten the screws.
(The same as ⑨ of Option (A))
- ⑥ Seal the cut part at Step ② with putty.

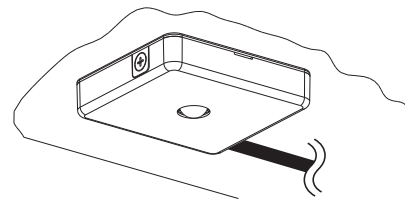

Option (C)

- ① Set up the switch box and relay wiring (prepare on site) in advance.
Seal the relay wiring inlet with putty.

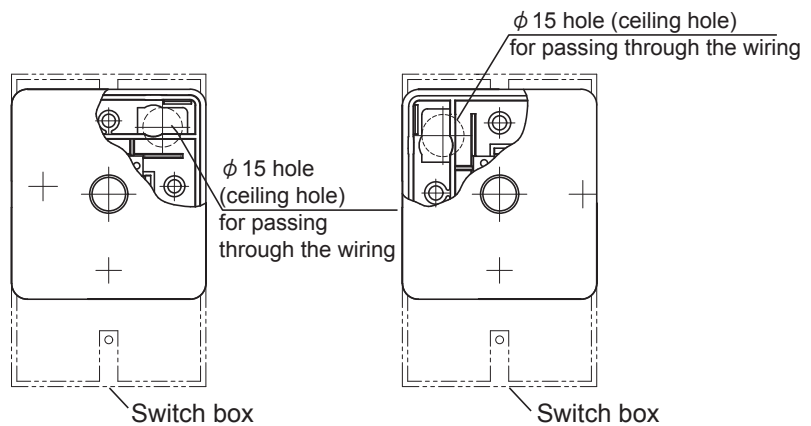

Positional relation for the switch box and installing holes

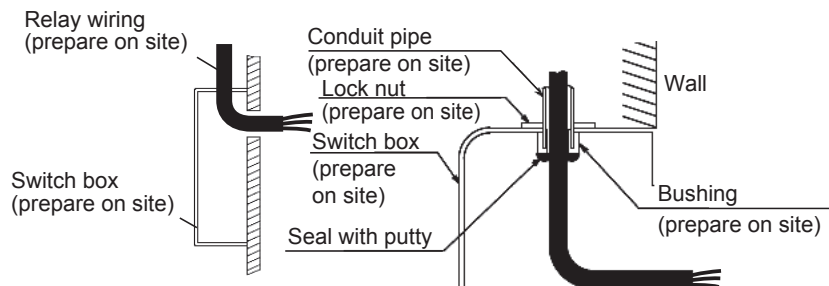

- ② Remove the screw at the side of the motion sensor and slide the upper case in the direction of the arrow. (The same as ② of Option (A))
- ③ Pull the wiring of the motion sensor. (The same as ③ of Option (A))
- ④ Pass the relay wiring through the hole on the lower case from switch box.

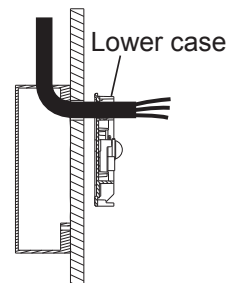

- ⑤ Fix the lower case to switch box using the installing hole (1 place).

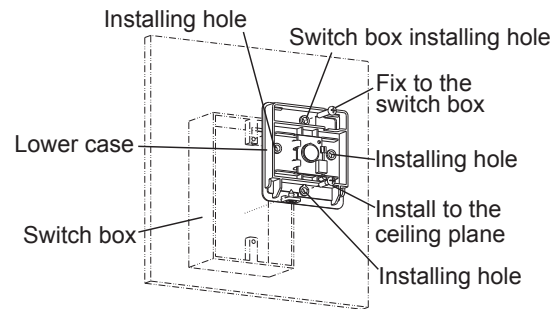

- ⑥ Connect the same color to the relay wiring (prepare on site) and the wiring of motion sensor. (The same as ⑥ of Option (A))

- ⑦ Place the connecting part between switch box and the hole of the lower case through passed the wiring at step ④ .

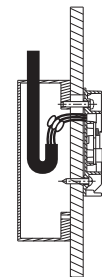

- ⑧ Taking care not to pinch the wirings, slip the upper case into the lower case, and tighten the screws. (The same as ⑧ of Option (A))

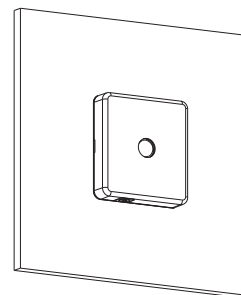



Wiring connection in the control box of indoor unit

CAUTION: Attached wirings to the motion sensor vary depending on the model of the indoor unit. Make sure your model before installing.

<In case of the CnL connector is on the indoor unit PCB (FDT/FDK/FDTC)>

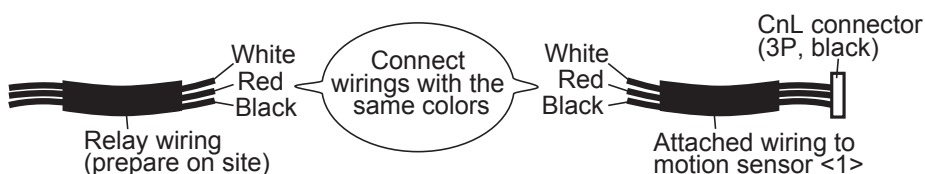

- ① Connect the same color to the relay wiring (prepare on site) and the attached wiring <1>.
- ② Remove the control box cover from the indoor unit.
- ③ Connect CnL connector (3P, black) to the PCB.



PFA012D633 

3.2.4 FDE series (LB-E)

WARNING

- Connect the wiring to the PCB in the control box on the indoor unit and hold the wiring securely so as not to apply unexpected stress on the PCB.
Loose connection or hold will cause abnormal heat generation or fire. 
- Make sure the power source is turned off when electric wiring work.
Otherwise, electric shock, malfunction and improper running may occur. 

CAUTION

- Do not install the motion sensor kit at the following places in order to avoid malfunction.



<ul style="list-style-type: none"> (1) Places exposed to direct sunlight (2) Places near heat devices (3) High humidity places (4) Hot surface or cold surface enough to generate condensation (5) Places exposed to oil mist or steam directly (6) Places affected by the direct air flow of the Indoor unit (7) Places where the motion sensor is influenced by the fluorescent lamp or sunlight 	<ul style="list-style-type: none"> (8) Places where the motion sensor is affected by infrared rays of any other communication devices (9) Places where some object may obstruct the motion sensor (10) Place that the motion sensor have a shock (11) Place with the strong radio wave or Static electricity (12) Place that motion sensor lens become tainted or have damaged. Dusty place
---	--
- Do not leave the motion sensor without the cover.
In case the cover needs to be detached, protect the motion sensor with a packaging or bag.
In order to keep it away from water and dust. 

Attention

- This manual describes how to install the motion sensor kit.
- Instruct the customer how to operate it correctly referring to the instruction manual.
- For the installation method of the air-conditioner itself, refer to the installation manual enclosed in the package.

① Accessories

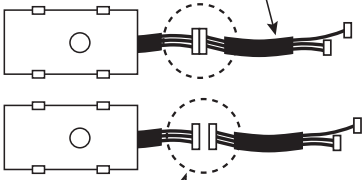
Please make sure that all components are in the package.

Motion sensor (※)	Manual
<p>Attached wiring to the motion sensor kit</p>  <div style="border: 1px solid black; padding: 5px; margin-top: 10px;"> <p>※ Wiring from the motion sensor and the attached wiring to the motion sensor kit have been connected when shipped from the factory. Remove the connector at the position of ○ mark and connect it to the attached wiring to the indoor unit before use.</p> </div>	

② Installing the motion sensor

- It is possible to install the motion sensor by replacing the indoor unit.
- The recommended height is lower than 4000 mm for motion sensor. When the installation height is higher, motion detection accuracy might be reduced.
- Sensor will detect the object with a different temperature from the surrounding.
- Sensor may not detect small children or infants with little motion.
- Use the separate motion sensor so that person's activity can be detected when the detectable area differs from the person's activity area.
- Use the separate motion sensor when using both wireless remote control and motion sensor together.

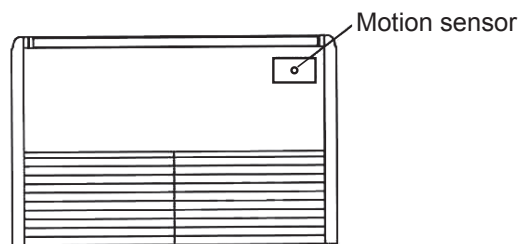

The detectable area

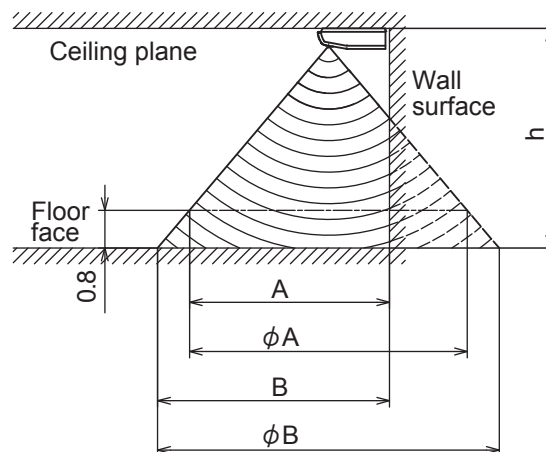

Height of the ceiling	h (m)	2.7	3.5	4.0
Detectable area	A (m)	2.9	3.9	4.5
Detectable area	φ A (m)	4.5	6.4	7.6
Detectable area	B (m)	3.9	4.8	5.4
Detectable area	φ B (m)	6.4	8.3	9.5

Installing the motion sensor (before installing the unit)

Motion sensor can be installed by replacing with a cover of the panel.

CAUTION: Install the motion sensor before installing the unit.

When installing the motion sensor after unit has been fixed, injury due to falling may result because of working at high place.

- ① Remove the connector that connects the motion sensor and the wiring.

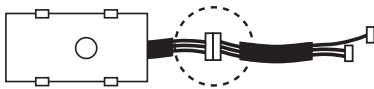

- ② Insert a tool into the dented part (2 places) of the panel cover, and wrench slightly not to damage the paintwork of the panel to remove the cover.
- ③ Connect the wiring from the panel's hole (attached to the indoor unit, color of the wiring: white, red and black, connector: 3P, white) to the wiring from the motion sensor. Make sure to install the motion sensor in the correct direction.

CAUTION: Do not remove the clamp fixed the wiring.

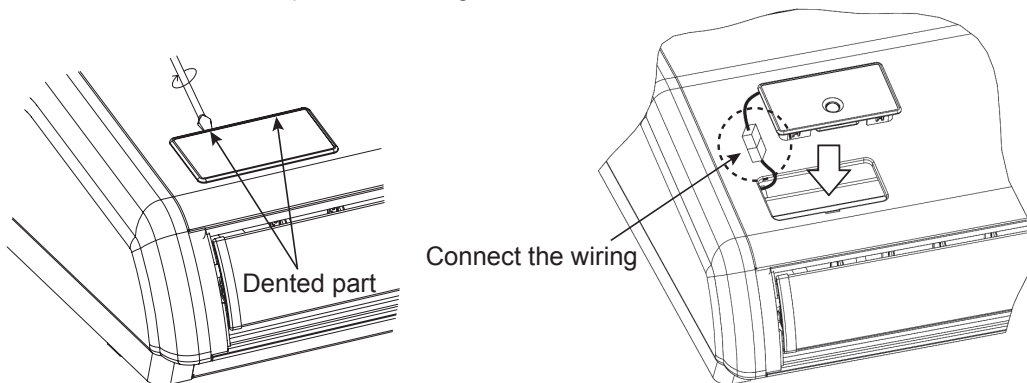

- ④ Install the motion sensor
Place the connector under the panel and install it to the panel with careful attention to the direction of the motion sensor.

CAUTION: Connect the connectors before installing the motion sensor.

In case of connecting after the motion sensor has been installed, it will be necessary to remove the panel.

Wiring connection in the control box

- ① Connect the wiring from the motion sensor (attached to the indoor unit, color of the wiring: white, red and black, connector: 3P, white) to the attached wiring to the motion sensor kit.
- ② Fix the wiring with clips (6 places).
- ③ Connect CnG connector (4P, blue) to the PCB.
- ④ Connect CnV2 connector (4P, black) to the PCB.

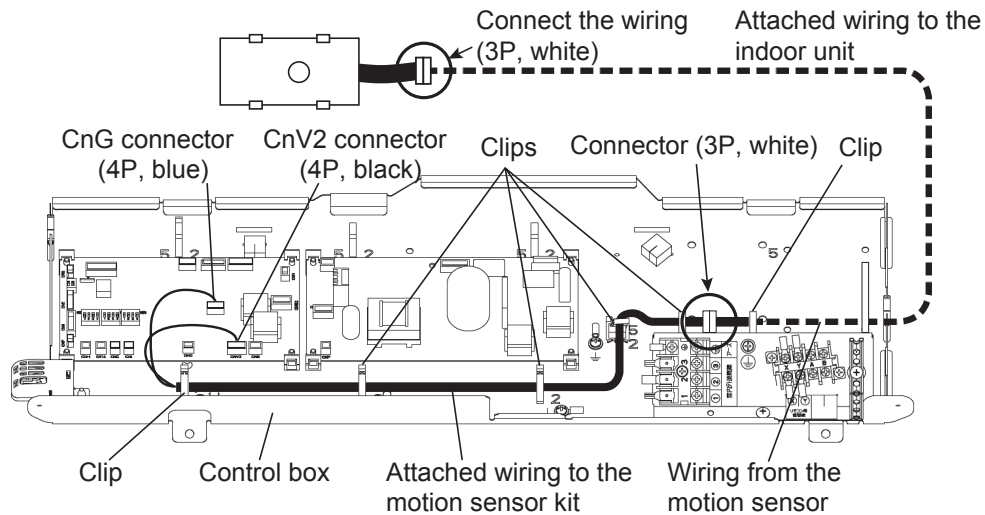

③ Setting the motion sensor

The motion sensor will not function if it is only installed.

Set the function of the motion sensor by the wired or wireless remote control. Refer to the manual instruction of each remote control for the setting procedure.

Note: It is not possible to set by the following remote control models or older.

Wired: RC-EX1A, RC-E5, RCH-E3

Wireless: RCN-E1R

3.2.5 User's manual

SAFETY PRECAUTIONS

⚠ WARNING

- **If a child, person with disease or other persons needed for assist uses this product, people around the person should take sufficient care.** !
 A halt of the air-conditioner due to abnormal situation or motion sensor's control may cause a feeling of sickness or accident.

ATTENTION

- The sensor may not detect a person near the border of detection range.
- Installation near an object with a different temperature from the surrounding may cause a false detection of human.
- Due to correction of temperature setting, some people may feel chilly.

This product uses infrared sensor to detect person's activity level to support control of air-conditioner. Please set the control you like from the remote control.

Indoor unit control	Detective situation	Description of control	Display of eco touch remote control
① Power control	Activity level is large	Lower the indoor temperature setting for comfort.	Power control ON
	Activity level is small	Raise the indoor temperature setting for energy-saving.	Power control ON
② Auto-off	No one is detected for 1 hour	Stop operation and stand by	In auto-off mode
	No one is detected for 12 hours	Stop operation	-
① + ②	Any combination of the above	Any of the above	Any of the above
All disabled (default setting)	-	Standard control	-

If the sensor is disconnected or defective, the control will be set as if it no detects (or less) activity level.

Refer to the next section for setting method.

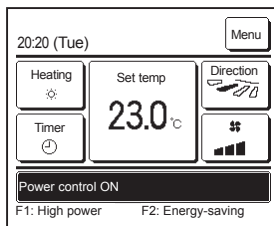

- When power control is enabled
 The amount of human motion is detected by a motion sensor to adjust the Set temp.
 During power control, "Power control ON" will be displayed on the message display.

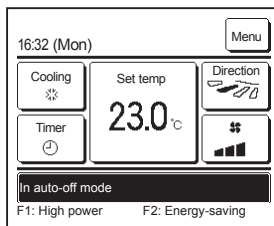

- When auto-off is enabled
 The unit will enter the "Operation wait" state when an hour has elapsed since the last time a human presence was detected and will be in "Complete stop" state after another 12 hours.
 "Operation wait"...The unit stops but will resume operation when human presence is detected. When the unit is in "Complete stop", "In auto-off mode" will be displayed on the message display.
 "Complete stop"...When auto-off is enabled, the unit stops. The unit will not resume operation even when human presence is detected.
 The message "In auto-off mode" will disappear from the message display, and the operation lamp will turn off.

Control setting (from eco touch remote control)

- Refer to the installation manual for eco touch remote control to activate the infrared sensor (motion sensor).

TOP screen **Menu** ⇒ **Service setting** ⇒ **Installation settings** ⇒ **Service password**

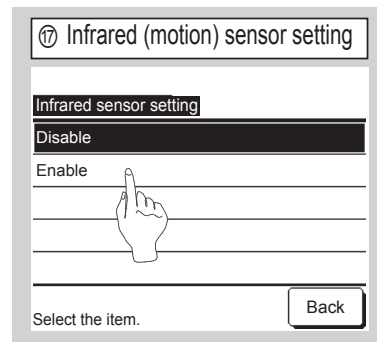
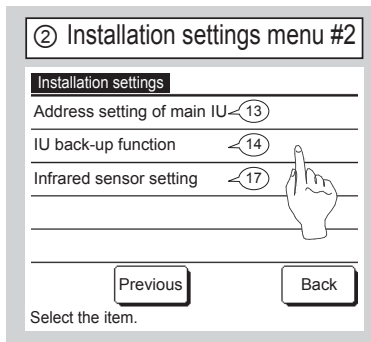
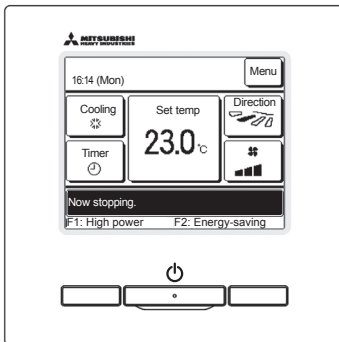

- Refer to the installation manual for eco touch remote control to set control mode.
 - Infrared sensor (motion sensor) control (for IUs with motion sensors)
Presence of humans and the amount of motion are detected by a motion sensor to perform various controls.
 - When the R/C is set as the sub R/C, the infrared sensor (motion sensor) control cannot be set.

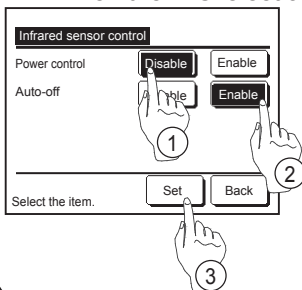

Tap the **Menu** button on the TOP screen and select **Energy-saving setting** ⇒ **Infrared sensor control** or **Motion sensor control**.

The Infrared sensor control screen and contents of the current settings are displayed.

- ① Enable/disable power control.
- ② Enable/disable auto-off.
- ③ After you set each item, tap the **Set** button.
The display returns to the Energy-saving setting menu screen.

Control setting (from wireless remote control)

- Refer to the installation manual for wireless remote control to enable motion sensor in **Indoor function settings**

Indoor function settings

1. How to set indoor functions

- ① Press the ON/OFF button to stop the unit.
- ② Press the desired one of the buttons shown item 2. while holding down the FUNCTION SETTING switch.
- ③ Use the selection buttons, ▲ and ▼, to change the setting.
- ④ Press the SET button.

The buzzer on the remote control signal receiver beeps twice, and the LED lamp flashes four times at two-second intervals.

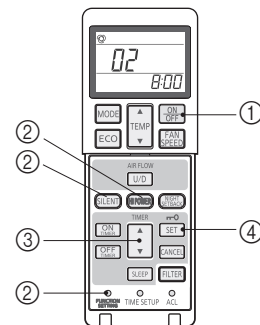

2. Setting details

Button	Number indicator	Function setting
SILENT	00	Infrared sensor setting (Motion sensor setting) : Disable
	01	Infrared sensor setting (Motion sensor setting) : Enable
HI POWER	00	Infrared sensor control (Motion sensor control) : Disable
	01	Infrared sensor control (Motion sensor control) : Power control only
	02	Infrared sensor control (Motion sensor control) : Auto OFF only
	03	Infrared sensor control (Motion sensor control) : Power control and Auto OFF

3.3 SIMPLE WIRED REMOTE CONTROL (RCH-E3)

Note:

Following functions of FDU indoor unit series are not able to be set with this simple wired remote control (RCH-E3).
 1. 4-fan speed setting (P-Hi/Hi/Me/Lo) → 3-fan speed setting (Hi/Me/Lo)

Names and functions of sections

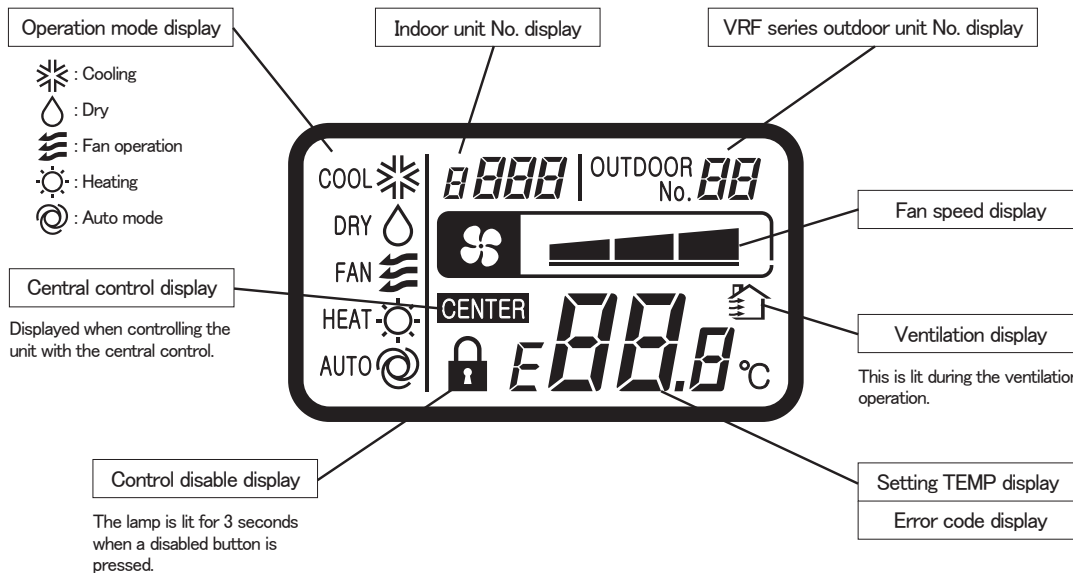
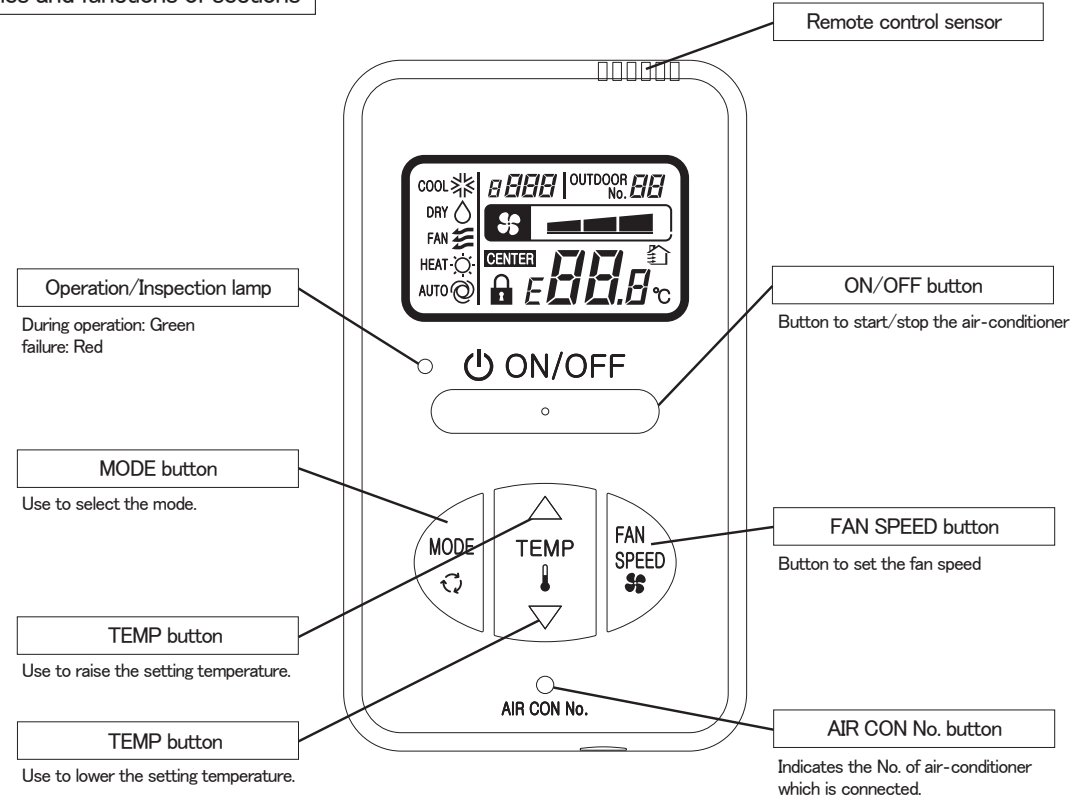

Installation of remote control

Do not install the remote control at the following places in order to avoid malfunction.

- (1) Places exposed to direct sunlight
- (2) Places near heat devices
- (3) High humidity places
- (4) Hot surface or cold surface enough to generate condensation
- (5) Places exposed to oil mist or steam directly
- (6) Uneven surface

PJZ000Z272

Remote control installation dimensions

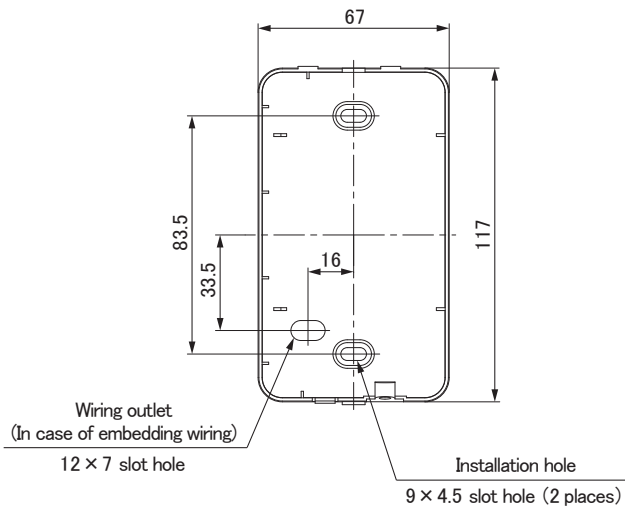

Note: Installation screw for remote control
M4 screw (2 pieces)

In case of embedding wiring

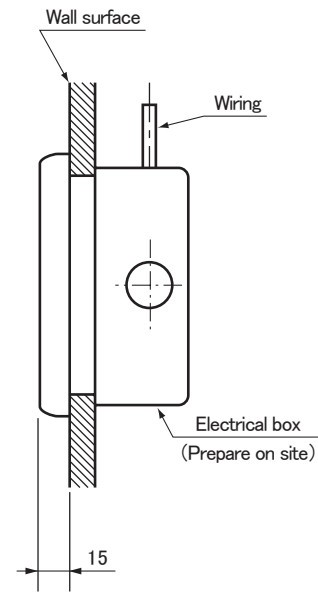

In case of exposing wiring

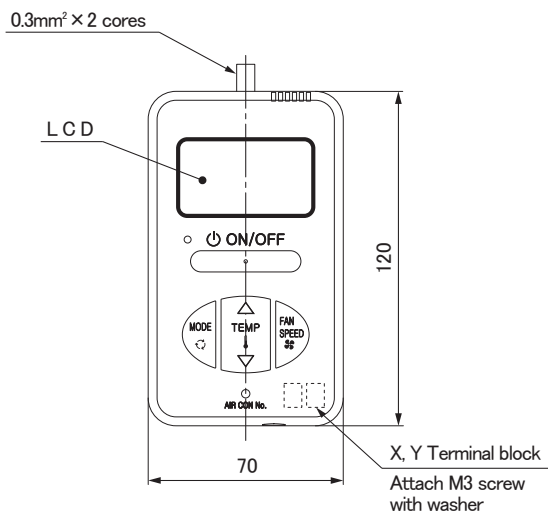

The remote control wiring can be extracted from the upper center. After the thin part in the upper side of the remote control upper case is scraped with a nipper or knife, remove burr with a file.

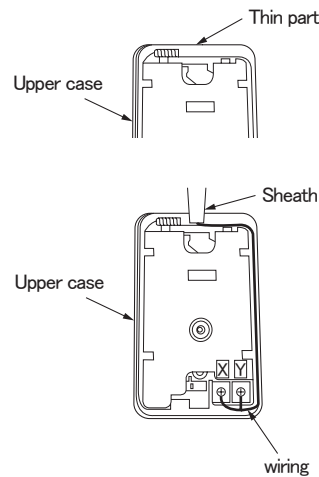

The peeling length of each wiring is as follows:

X wiring : 160mm
Y wiring : 150mm

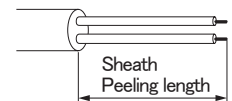

Wiring specifications

- (1) Wiring of remote control should use 0.3mm² × 2 cores wires or cables. (on-site configuration)
- (2) Maximum prolongation of remote control wiring is 600m.
If the prolongation is over 100m, change to the size below.
But, the wiring in the remote control case should be 0.3mm² (recommended) to 0.5mm².
Change the wire size outside of the case according to wire connecting. Waterproof treatment is necessary at the wire connecting section. Be careful about contact failure.

Unit:mm

Length	Wiring thickness
100 to 200m	0.5mm ² × 2 cores
Under 300m	0.75mm ² × 2 cores
Under 400m	1.25mm ² × 2 cores
Under 600m	2.0mm ² × 2 cores

Adapted to **RoHS** directive

Simple Remote Control Installation Manual

PJZ012D069

Read together with indoor unit's installation manual.

WARNING

- **Fasten the wiring to the terminal securely and hold the cable securely so as not to apply unexpected stress on the terminal.**
Loose connection or hold will cause abnormal heat generation or fire.
- **Make sure the power source is turned off when electric wiring work.**
Otherwise, electric shock, malfunction and improper running may occur.

CAUTION

- **Do not install the remote control at the following places in order to avoid malfunction.**
 - (1) Places exposed to direct sunlight
 - (2) Places near heat devices
 - (3) High humidity places
 - (4) Hot surface or cold surface enough to generate condensation
 - (5) Places exposed to oil mist or steam directly
 - (6) Uneven surface
- **Do not leave the remote control without the upper case.**
In case the upper case needs to be detached, protect the remote control with a packaging box or bag in order to keep it away from water and dust.

Accessories	Remote control, wood screw (φ 3.5 × 16) 2 pieces
Prepare on site	Remote control cord (2 cores) (Refer to [2. Installation and wiring of remote control]) [In case of embedding cord] Electrical box, M4 screw (2 pieces) [In case of exposing cord] Cord clamp (if needed)

1. Installation procedure

In case of embedding cord

- (1) **Make certain to remove** the screw on the bottom surface of the remote control.
- (2) Remove the upper case of the remote control. Insert a flat-blade screwdriver to a concave portion of the bottom surface of the remote control and slightly twist it, and the case is removed.
- (3) Pre-bury the electrical box and remote control cord.
- (4) Prepare two M4 screws (recommended length: 12 – 16mm), and install the lower case to the electrical box. Do not use a screw whose screw head is larger than the height of the wall around the screw hole.

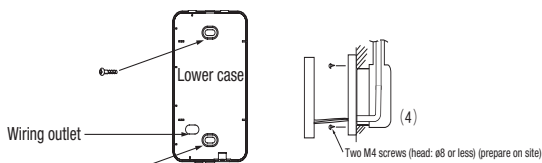

- (5) Connect the remote control cord to the terminal block. Connect the terminals (X and Y) of the remote control and the terminals (X and Y) of the indoor unit. (No polarity of X and Y)
- (6) Mount the upper case for restoring to its former state so as not to crimp the remote control cord, and secure with the removed screw.

In case of exposing cord

- (1) **Make certain to remove** a screw on the bottom surface of the remote control.
- (2) Remove the upper case of the remote control. Insert a flat-blade screwdriver to a concave portion of the bottom surface of the remote control and slightly twist it, and the case is removed.
- (3) The remote control cord can be extracted from the upper center. After the thin part in the upper side of the remote control upper case is scraped with a nipper or knife, remove burr with a file.
- (4) The lower case of the remote control is mounted to a flat wall with two accessory wood screws.
- (5) Connect the remote control cord to the terminal block. Connect the terminals (X and Y) of the remote control and the terminals (X and Y) of the indoor unit. (No polarity of X and Y)
The wiring route is as shown in the right.

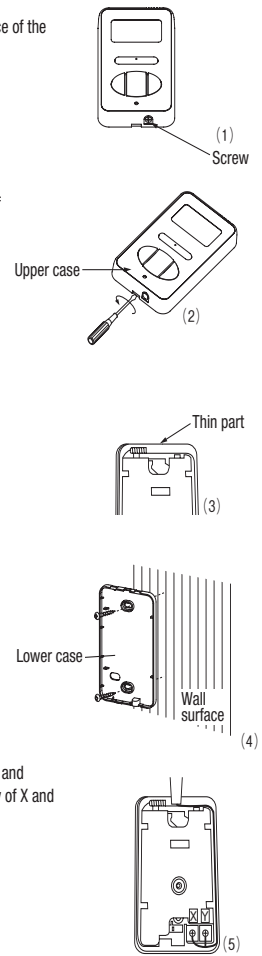

The wiring in the remote control case should be 0.3 mm² (recommended) to 0.5 mm² at maximum.

Further, peel off the sheath.

The peeling length of each wiring is as follows:

X wiring : 160mm
Y wiring : 150mm

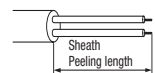

- (6) Mount the upper case for restoring to its former state so as not to crimp the remote control cord, and secure with the removed screw.
- (7) In the case of exposing installation, secure the remote control cord to the wall surface with a cord clamp so as not to loosen the remote control cord.

2. Installation and wiring of remote control

- (1) Wiring of remote control should use 0.3mm² × 2 cores wires or cables. (on-site configuration)
- (2) Maximum prolongation of remote control wiring is 600 m. If the prolongation is over 100m, change to the size below. But, the wiring in the remote control case should be 0.3mm² (recommended) to 0.5mm². Change the wire size outside of the case according to wire connecting. Waterproof treatment is necessary at the wire connecting section. Be careful about contact failure.

100 - 200m ······ 0.5mm² × 2 cores
Under 300m ······ 0.75mm² × 2 cores
Under 400m ······ 1.25mm² × 2 cores
Under 600m ······ 2.0mm² × 2 cores

3. Master/ slave setting when more than one remote control are used

- (1) Up to two remote controls can be connected to one unit (or one group) of indoor unit.

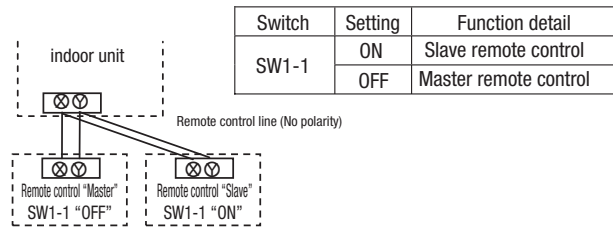

Switch	Setting	Function detail
SW1-1	ON	Slave remote control
	OFF	Master remote control

- (2) Set the switch SW1-1 of the slave remote control is "Slave" (ON). The factory default is set as "Master" (OFF).

(Note) • The remote control temperature sensor enabled setting can be set only to the master remote control.

- Install the master remote control at the position to detect room temperature.
- The air-conditioner operation follows the last operation of the remote control in case of the master / slave setting.

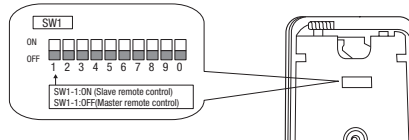

4. The indication when power source is supplied

- (1) At the time of turning the power source on, after the light is on for the first 2 seconds, the display becomes as shown below.

The number displayed on the upper side of LCD in the remote control is the software number, and this is not an error code.

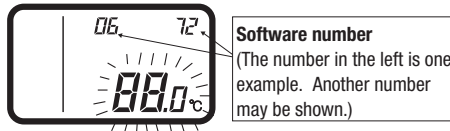

- (2) Then, "88.0 °C" blinks on the remote control until the communication between the remote control and the indoor unit is established.
- (3) In the case of connecting one remote control with one unit (or one group) of indoor unit, make certain to set the master remote control (factory default). If the slave remote control is set, a communication cannot be established.
- (4) If a state where the communication between the remote control and the indoor unit cannot be established continues about for 30 minutes, "E" is displayed. Confirm the wiring of the indoor unit and the outdoor unit and master/slave setting of the remote control.



5. Confirmation method for return air temperature

Return air temperature can be confirmed by the remote control operation.

- (1) Press **AIR CON No.** button for over 5 seconds.

"88" blinks on the temperature setting indicator.
("88" blinks for approximately 2 seconds while data is read.)



Then, the return air temperature is displayed.

(Example) return air temperature: "27 °C" (blinking)

(Note) For the return air temperature, in the normal case, the return air temperature of the indoor unit is displayed; however, in the case that the remote control temperature sensor is effective, detected temperature by the remote control temperature sensor is displayed.

- (2) Press **ON/OFF** button.
End.

[In the case that the remote temperature sensor is ineffective and plural indoor units are connected to one remote control.]

- (1) Press **AIR CON No.** button for over 5 seconds.

indoor unit No. indicator: "U 000" (blinking)
(Among the connected indoor units, the lowest number is displayed.)



- (2) Press **TEMP Δ** or **TEMP ∇** button.
Select the indoor unit No.

- (3) Press **MODE** button.
Decider the indoor unit No.

(Example) indoor unit No. indicator: "U 000"

"88" blinks on the temperature setting indicator. (blinking for approximately 2 to 10 seconds while data is read) Then, the return air temperature is displayed. When **AIR CON No.** is pressed, return to the indoor unit selection display (example, "U 000").

- (4) Press **ON/OFF** button.
End.

6. Function setting

Each function of the remote control and the indoor unit is automatically set to the initial setting, which is the standard use, on the occasion of connecting the remote control with the indoor unit. In the case of the standard use, the setting change is unnecessary. However, if you would like to change the initial setting "○", change the setting for only the item of the function number. **Record the setting contents and stored them.**

(1) Function setting item by switch on PCB

Switch No.	Setting	Setting detail	Initial setting
SW1-1	ON	Slave remote control	
	OFF	Master remote control	○
SW1-2	ON	Remote control temperature sensor enabled	
	OFF	Remote control temperature sensor disabled	○
SW1-3	ON	"MODE" button prohibited	
	OFF	"MODE" button enabled	○
SW1-4	ON	"ON/OFF" button prohibited	
	OFF	"ON/OFF" button enabled	○

Switch No.	Setting	Setting detail	Initial setting
SW1-5	ON	"TEMP" button prohibited	
	OFF	"TEMP" button enabled	○
SW1-6	ON	"FAN SPEED" button prohibited	※ Note 1
	OFF	"FAN SPEED" button enabled	※ Note 1
SW1-7	ON	Auto restart function enabled	
	OFF	Auto restart function disabled	○
SW1-8, 9, 0	OFF	Not used	

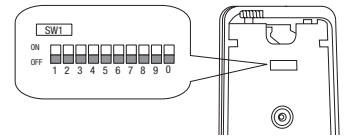

- As for the slave remote control, function setting is impossible other than SW1-1.
- In the indoor unit with only one fan speed, "FAN SPEED" button cannot be enabled.

(2) Function setting item by button operation

Classification	Function No.	Function	Setting No.	Setting	Initial setting	Remarks
Remote control function	01	Indoor unit fan speed	01	Fan speed: three steps	※ Note 1	The fan speed is three steps, ㊦㊦㊦ - ㊦㊦㊦ - ㊦㊦.
			02	Fan speed: two steps (Hi-Lo)	※ Note 1	The fan speed is two steps, ㊦㊦㊦ - ㊦㊦.
			03	Fan speed: two steps (Hi-Me)		The fan speed is two steps, ㊦㊦㊦ - ㊦㊦.
			04	Fan: one step	※ Note 1	The fan speed is fixed to one step.
	03	Remote control thermostat at the time of cooling	01	Remote control temperature sensor: no offset	○	
			02	Remote control temperature sensor: +3.0 °C		At the time of cooling, in the case of remote control temperature sensor enabled, offset temperature at +3.0°C.
			03	Remote control temperature sensor: +2.0 °C		At the time of cooling, in the case of remote control temperature sensor enabled, offset temperature at +2.0°C.
			04	Remote control temperature sensor: +1.0 °C		At the time of cooling, in the case of remote control temperature sensor enabled, offset temperature at +1.0°C.
			05	Remote control temperature sensor: -1.0 °C		At the time of cooling, in the case of remote control temperature sensor enabled, offset temperature at -1.0°C.
			06	Remote control temperature sensor: -2.0 °C		At the time of cooling, in the case of remote control temperature sensor enabled, offset temperature at -2.0°C.
			07	Remote control temperature sensor: -3.0 °C		At the time of cooling, in the case of remote control temperature sensor enabled, offset temperature at -3.0°C.
	04	Remote control thermostat at the time of heating	01	Remote control temperature sensor: no offset	○	
			02	Remote control temperature sensor: +3.0 °C		At the time of heating, in the case of remote control temperature sensor enabled, offset temperature at +3.0°C.
			03	Remote control temperature sensor: +2.0 °C		At the time of heating, in the case of remote control temperature sensor enabled, offset temperature at +2.0°C.
			04	Remote control temperature sensor: +1.0 °C		At the time of heating, in the case of remote control temperature sensor enabled, offset temperature at +1.0°C.
			05	Remote control temperature sensor: -1.0 °C		At the time of heating, in the case of remote control temperature sensor enabled, offset temperature at -1.0°C.
			06	Remote control temperature sensor: -2.0 °C		At the time of heating, in the case of remote control temperature sensor enabled, offset temperature at -2.0°C.
			07	Remote control temperature sensor: -3.0 °C		At the time of heating, in the case of remote control temperature sensor enabled, offset temperature at -3.0°C.
	05	Ventilator setting	01	No ventilator connection	○	
			02	Ventilator links air-conditioner		In case of Single split series, by connecting ventilator device to CNT of the indoor printed circuit board (in case of VRF series, by connecting it to CND of the indoor printed circuit board), the operation of ventilator device is linked with the operation of indoor unit.
	06	"Auto" operation setting	01	"Auto" operation enabled	※ Note 1	
02			"Auto" operation disabled	※ Note 1	"Auto" operation disabled	
07	Operation permission/prohibition	01	Disabled	○		
		02	Enabled		Operation permission/prohibition control is enabled.	
08	External input	01	Level input	○		
		02	Pulse input			
09	Fan speed setting	01	Standard	※ Note 2		
		02	High speed 1	※ Note 2		
		03	High speed 2	※ Note 2		
10	Fan remaining operation at the time of cooling	01	No remaining operation	○	After cooling stopped, no fan remaining operation	
		02	0.5 hours		After cooling stopped, fan remaining operation for 0.5 hours	
		03	1 hour		After cooling stopped, fan remaining operation for 1 hour	
		04	6 hours		After cooling stopped, fan remaining operation for 6 hours	
11	Fan remaining operation at the time of heating	01	No remaining operation	○	After heating stopped or after heating thermostat OFF, no fan remaining operation	
		02	0.5 hours		After heating stopped or after heating thermostat OFF, fan remaining operation for 0.5 hours	
		03	2 hours		After heating stopped or after heating thermostat OFF, fan remaining operation for 2 hours	
		04	6 hours		After heating stopped or after heating thermostat OFF, fan remaining operation for 6 hours	
12	Setting temperature offset at the time of heating	01	No offset	○		
		02	Setting temperature offset + 3.0 °C		The setting temperature at the time of heating is offset by +3.0 °C.	
		03	Setting temperature offset + 2.0 °C		The setting temperature at the time of heating is offset by +2.0 °C.	
		04	Setting temperature offset + 1.0 °C		The setting temperature at the time of heating is offset by +1.0 °C.	
13	Heating fan controller	01	Low fan speed	※ Note 1	At the time of heating thermostat OFF, operate with low fan speed.	
		02	Setting fan speed		At the time of heating thermostat OFF, operate with the setting fan speed.	
		03	Intermittent operation	※ Note 1	At the time of heating thermostat OFF, intermittently operate.	
		04	Fan off		At the time of heating thermostat OFF, a fan will be stopped. When the remote control thermostat is enabled, automatically set to "Fan off". Do not set at the time of the indoor unit temperature sensor.	
14	Return air temperature offset	01	No offset	○		
		02	Return air temperature offset +2.0 °C		Offset the return air temperature of the indoor unit by +2.0 °C.	
		03	Return air temperature offset +1.5 °C		Offset the return air temperature of the indoor unit by +1.5 °C.	
		04	Return air temperature offset +1.0 °C		Offset the return air temperature of the indoor unit by +1.0 °C.	
		05	Return air temperature offset -1.0 °C		Offset the return air temperature of the indoor unit by -1.0 °C.	
		06	Return air temperature offset -1.5 °C		Offset the return air temperature of the indoor unit by -1.5 °C.	
		07	Return air temperature offset -2.0 °C		Offset the return air temperature of the indoor unit by -2.0 °C.	

Note 1: The symbol "※" in the initial setting varies depending upon the indoor unit and the outdoor unit to be connected, and this is automatically determined as follows:

Switch No. / Function No.	Function	Setting	Product model
SW1-6	"FAN SPEED" button	"FAN SPEED" button prohibited	Product model whose indoor fan speed is only one step
		"FAN SPEED" button enabled	Product model whose indoor fan speed is two steps or three steps
Remote control function 01	Indoor unit fan speed	Fan speed: three steps	Product model whose indoor unit fan speed is three steps
		Fan speed: two steps (Hi-Lo)	Product model whose indoor unit fan speed is two steps
		Fan speed: two steps (Hi-Me)	Product model whose indoor unit fan speed is only one step
Remote control function 06	"Auto" operation setting	"Auto" operation enabled	Product model where "Auto" mode is selectable
		"Auto" operation disabled	Product model without "Auto" mode
Indoor unit function 13	Heating fan control	Low fan speed	Product model except FDUS
		Intermittent operation	FDUS

Note 2: Fan speed of "High speed" setting

Fan speed setting	Indoor unit fan speed setting		
	㊦㊦㊦ - ㊦㊦㊦ - ㊦㊦	㊦㊦㊦ - ㊦㊦	㊦㊦㊦ - ㊦㊦
Standard	Hi - Mid - Lo	Hi - Lo	Hi - Mid
High speed 1・2	UHi - Hi - Mid	UHi - Mid	UHi - Hi

Initial setting of some indoor unit is "High speed".

Note 3: As for plural indoor unit, set indoor functions to each master and slave indoor unit. But only master indoor unit is received the setting change of indoor unit function "07 Operation permission/prohibition" and "08 External input".

7. How to set functions by button operation

- (1) Stop air-conditioner, and simultaneously press **AIR CON No.** and **MODE** buttons at the same time for over three seconds.
The function number "01" blinks in the upper right.

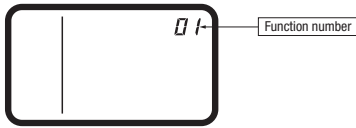

- (2) Press **TEMP▲** or **TEMP▼** button.
Select the function number.
- (3) Press **MODE** button.
Decide the function number.

- (4) [In the case of selecting the remote control function (01-06)]
- ① The current setting number of the selected function number blinks (Example)
Function number: "01" (lighting)
Setting number: "01" (blinking)

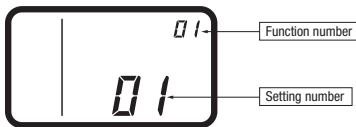

- ② Press **TEMP▲** or **TEMP▼** button.
Select the setting number.

- ③ Press **MODE** button.
The setting is completed.

Light is on for approximately 3 to 20 seconds while data of the decided function No. and setting No. is transmitted.

(Example)
Function number: "01" (lighting for 3 to 20 seconds)
Setting number: "01" (lighting for 3 to 20 seconds)

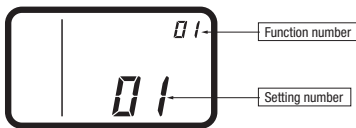

Then, the screen goes back to the function number blinking indication (1), if the setting is sequentially conducted, continue with the same procedures. If the setting is finished, proceed to (5).

- (5) Press **ON/OFF** button.
The setting is completed.

- Even if **ON/OFF** button is pressed during setting, the setting is ended. However, any details where the setting has not been completed will be ineffective.
- The setting contents are stored in the control, and even if the power failure occur, this will not be lost.

[Confirmation method for current setting]

According to the operation, the "setting number" displayed first after selecting "function number" and pressing **MODE** button is the currently set content. (However, in the case of selecting "U ALL" (all units), the setting number of the lowest number among the indoor units is displayed.)

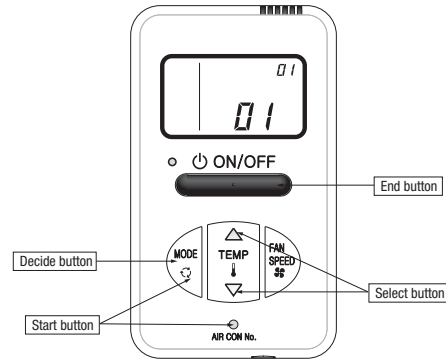

[In the case of selecting the indoor unit function (07-14)]

- ① "88" blinks on the temperature setting indicators.
(blinking for approximately 2 to 10 seconds while data are read)

After that, the current setting number of the selected function number blinks.
(Example)

Function number: "07" (lighting)
Setting number: "01" (blinking)

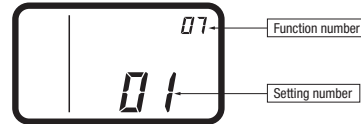

Proceed to ②.

[Note]

a. In the case of connecting one remote control to plural indoor units, the display will be as follows:

Indoor unit No. display: "U 000" (blinking)
(Display the lowest number among the connected indoor units.)

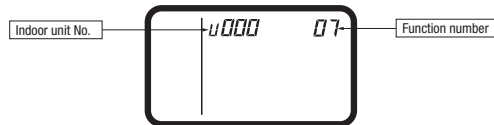

b. Press **TEMP▲** or **TEMP▼** button.

Select the indoor unit No. to be set.
If "U ALL" is selected, the same setting can be set to all units.

c. Press **MODE** button.

Decide the indoor unit No.
"88" blinks on the temperature setting indicators. (blinking for 2 to 10 seconds while data is read)

When **AIR CON No.** button is pressed, go back to the indoor unit selection display (for example, "U 000" blinking).

- ② Press **TEMP▲** or **TEMP▼** button.
Select the setting number

③ Press **MODE** button.

The setting is completed.
Light is on for approximately 3 to 20 seconds while data of the decided function No. and setting No. is transmitted.

(Example)
Indoor unit No.: "U 000" (lighting for 3 to 20 seconds)
Function number: "07" (lighting for 3 to 20 seconds)
Setting number: "01" (lighting for 3 to 20 seconds)

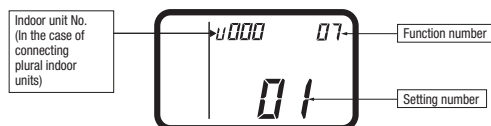

Then, the screen goes back to the function number blinking indication (1), if the setting is sequentially conducted, continue with the same procedures. If the setting is finished, proceed to (5).

3.4 OA SPACER (FDTC series)

This manual describes the installation methods for OA spacer (TC-OAS-E2) and the duct joint (TC-OAD-E).
 ◎ This OA spacer is designed for assembling on the indoor unit (FDTC Series), not for be using independently.

PJZ012D125





Application model	FDTC15-56KXZE1 FDTC25-60VH
-------------------	-------------------------------

- ◎ Prepare the duct (size: ø75) and the booster fan at site.
- ◎ For the installation of indoor unit, refer to the installation manual attached to the indoor unit.

SAFETY PRECAUTIONS

- Read the "SAFETY PRECAUTIONS" carefully first of all and then strictly follow it during the installation work in order to protect yourself.

⚠ WARNING

- **Installation should be performed by the specialist.**
If you install the unit by yourself, it may lead to serious trouble such as water leakage, electric shock, fire, and injury due to overturn of the unit. 
- **Install the system correctly according to these installation manuals.**
Improper installation may cause explosion, injury, water leakage, electric shock, and fire. 
- **Use the genuine accessories and the specified parts for installation.**
If parts unspecified by our company are used it could cause water leakage, electric shock, fire, and injury due to overturn of the unit. 
- **Turn off the power source during servicing or inspection work.**
If the power is supplied during servicing or inspection work, it could cause electric shock and injury by the operating fan. 
- **Shut off the power before electrical wiring work.**
It could cause electric shock, unit failure and improper running. 







⚠ CAUTION

- **Do not install and use the unit where corrosive gas (such as sulfuric acid gas etc.) or flammable gas (such as thinner, petroleum etc.) may be generated or accumulated, or volatile flammable substances are handled.**
It could cause the corrosion of heat exchanger, breakage of plastic parts etc. And inflammable gas could cause fire. 





① Before installation

- Confirm the following parts are included:

OA spacer (TC-OAS-E2)

Spacer	Bracket 1	Bracket 2	Bracket 3	Bracket 4	Bolt
					
1	2	2	2	2	8

Duct joint (TC-OAD-E)

Duct Joint	Screw	Insulation 1 (120 × 54)	Insulation 2 (40 × 60)
			
1	6	1	2

② Prior study before installation (Usage limitation)

(1) Temperature conditions for OA spacer

- Adjust the temperature conditions of mixed air with outdoor air and indoor air within the usage range of suction air temperature for the air-conditioner.
- The usage temperature conditions of intake outdoor air and indoor air around the ducts are shown in the following table.
- If the temperature conditions of intake outdoor air do not meet, process the outdoor air before intaking.

Operation mode	Usage temperature conditions	
	Intake outdoor air	Indoor air around the ducts
In heating	5°C DB or higher	18.5°C WB or lower and 60% RH or lower
In cooling	29°C DB or lower and 80% RH or lower	20°C DB or higher

(2) Intake outdoor air volume

- Intake outdoor air volume is 3.0 m³/min at the maximum (when two sets of duct joints are used). Up to two sets of duct joint can be installed on OA spacer.
- In case one set of duct joint is installed: 1.5 m³/min max.
- In case two sets of duct joint is installed: 3.0 m³/min max.

(3) Selection of booster fan

- Select the booster fan based on the duct resistance plus the pressure loss at the duct joint. (See the figure)

(4) Other conditions

- Determine the capacity of air conditioner based on the calculation of air-conditioning load including the heat load of intake outdoor air.
- Install the filter for the intake outdoor air and the reverse flow prevention damper during the duct work at site.
- Insulate the duct and duct joint in order to prevent dewing.
- Interlock the operation of booster fan with ON/OFF operation of the indoor unit. (See Section 7.)

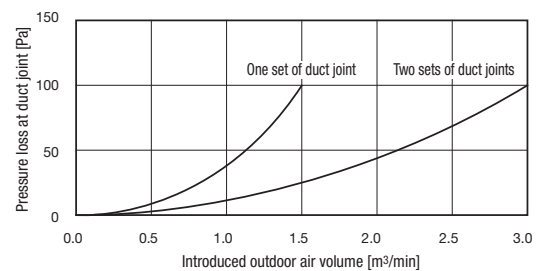
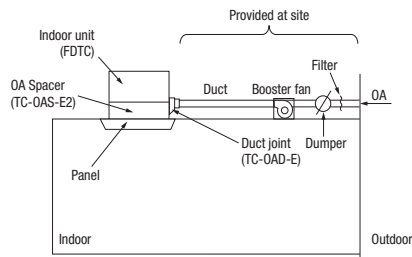
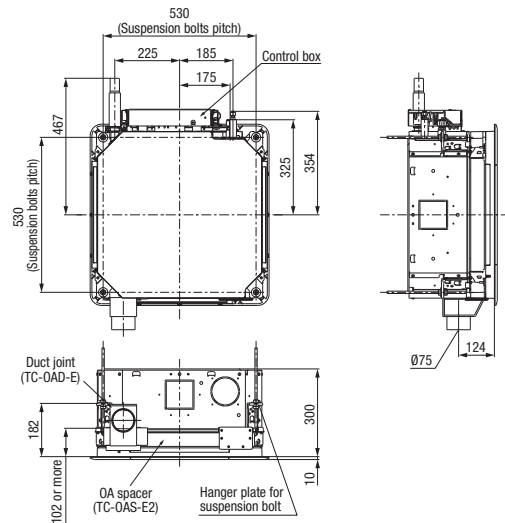

③ Installation of duct joint (TC-OAD-E) onto OA spacer

- There are two places where the duct joint can be installed.

When installing one duct joint

Install OA spacer at either one of two installation places on the duct joint.

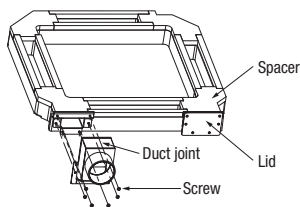

To install the duct joint, screw it in as shown at left.

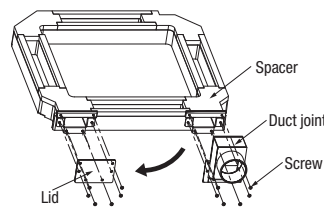

When installing the duct joint at the lid side, remove the lid and reinstall it at the other end before installing the duct joint.

When installing two duct joints

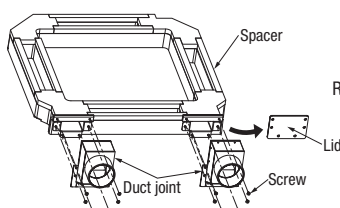

Remove the lid and then install two pieces of duct joint.

④ Installation of OA spacer on the indoor unit

OA spacer can be installed regardless whether the indoor unit has already been hanged or not.
(It is recommended to install before hanging the unit for convenience of installation.)

1-1. When installing OA spacer before hanging the indoor unit

- ① Placing OA spacer on the indoor unit, fix the brackets 1 and 2 (2 pieces each) with bolts.
Install OA spacer in the appropriate position that the duct joint side of OA spacer becomes opposite to the control box of indoor unit (FDTC).

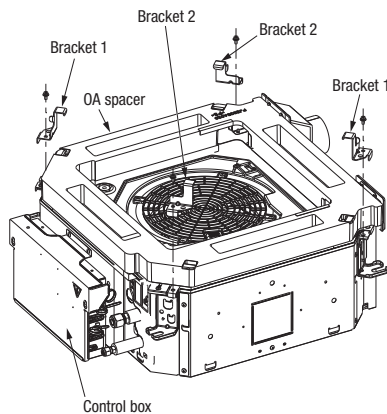

- ② Fix the brackets 3 and 4 (2 pieces each) with bolts.

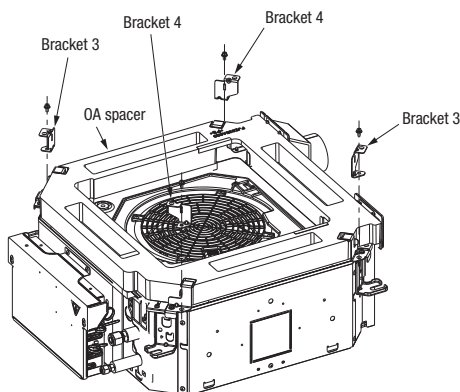

2. Applying insulation

Applying the insulation attached to duct joint set (TC-OAD-E)

- ① Applying the insulation 1 as shown in the figure.
- ② Applying the insulation 2 as shown in the figure.

* Be sure to cover the entire surface of sheet metal of the duct joint with the insulation.

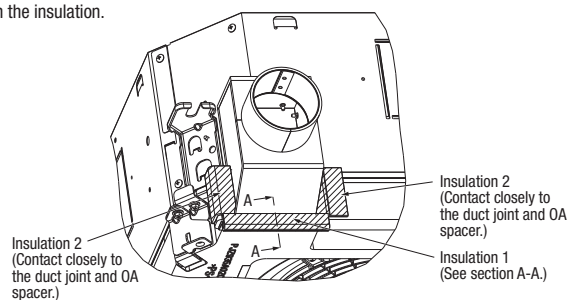
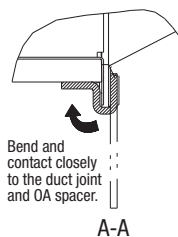

1-2. When installing OA spacer after hanging the indoor unit

- ① After hanging the indoor unit (*), fix the bracket 1 (2 pieces) temporarily with bolt by 2 turns as shown in the figure.
* For the height (position) of hanging the indoor unit, refer to Section 5.

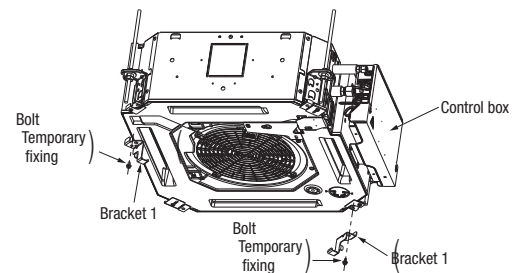

- ② Install OA spacer.
 - i. Install it in the way that the recess of OA spacer will fit on the bracket 1 fixed temporarily at the step ①.
 - ii. Tighten the bolt of bracket 1.
 - iii. Fix the bracket 2 with bolt. (Tighten up)

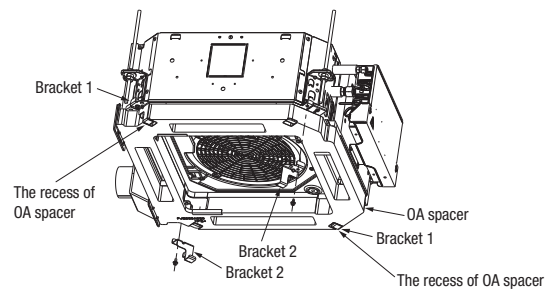

- ③ Fix the brackets 3 and 4 (2 pieces each) with bolts.

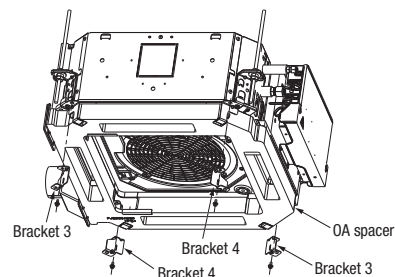

⑤ Installation of indoor unit

Work procedure

- This unit is designed for 2 × 2 grid ceiling.
If necessary, please detach the T bar temporarily before you install it.
If it is installed on a ceiling other than 2 × 2 grid ceiling, provide an inspection port on the control box side.
- Arrange the suspension bolt at the right position (530mm/530mm).
- Make sure to use four suspension bolts and fix them so as to be able to hold 500N load.
- Ensure that the lower end of the suspension bolt should be 102mm above the ceiling plane. Temporarily put the four lower nuts 182mm above the ceiling plane and the upper nuts on distant place from the lower nuts in order not to obstruct hanging the indoor unit or adjust the indoor unit position, and then hang the indoor unit.
- Adjust the indoor unit position after hanging it by inserting the level gauge (Packed together with the indoor unit.) attached on the package into the air supply port and checking if the gap between the ceiling plane and the indoor unit is appropriate. (*) In order to adjust the indoor unit position, adjust the lower nuts while the upper nuts are put on distant place. Confirm there is no backlash between the hanger plate for suspension bolt and the lower nut and washer.
* Use the level gauge only when OA spacer has been installed before hanging (④ 1-1 only).

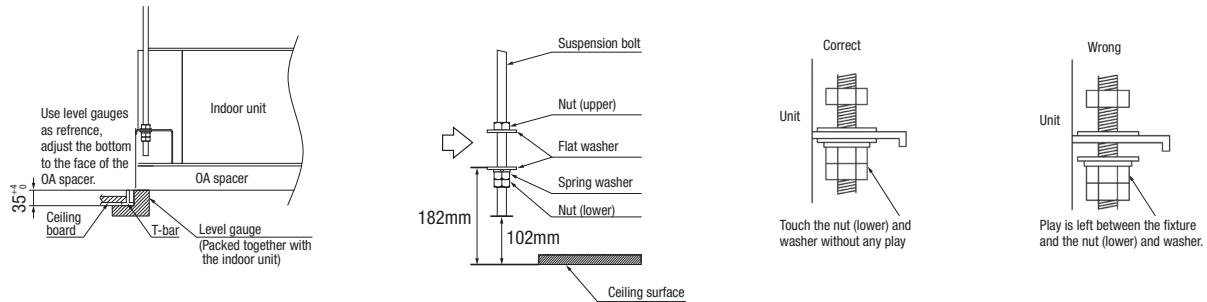

⑥ Installation of panel

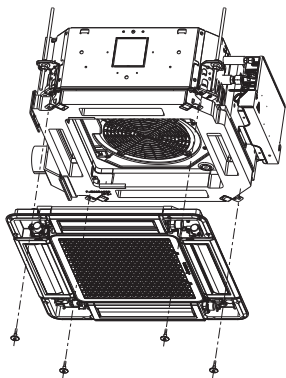

Tighten the panels to the brackets 3 and 4 with bolts.
For further details, refer to the installation manual of panel.
(Caution) Connect the connector of lower motor within the control box.

⑦ Interlocking with the indoor unit fan

- Connect the Single split series and the VRF series to CNT on the indoor PCB and to CND on the indoor PCB respectively. If a ventilation device is connected, be geared with the motion of indoor device (ON: DC12V output, OFF: 0V output), the ventilation device is operated/stopped.
- Set it at "VENT LINK" by selecting "No. 11 VENT LINK SET" from the functional setting by remote control. For details, refer to the "ELECTRIC WIRING WORK INSTRUCTION" of indoor unit.

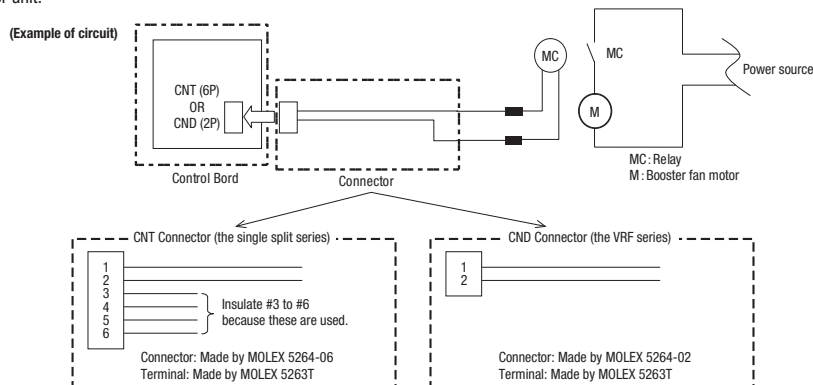

(Caution) Although the indoor unit fan stops during the defrosting or oil return operation, the booster fan is operating.
Use a total heat exchanger, if necessary.



3.5 DUCT JOINT (FDTC series)

PJZ012D073

● This product is used by assembling on the spacer (TC-OAS-E2)

1. Before installation

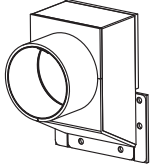
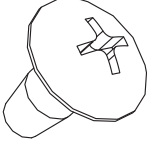
● Confirm the following parts are included:

Duct joint	Screw	Insulation 1 (120 × 54)	Insulation 2 (40 × 60)
			
1	6	1	2

2. Regarding the use of this product

- Fix the product on the spacer (TC-OAS-E2) as shown below.
- For the installation method, refer to the installation manual of the spacer.

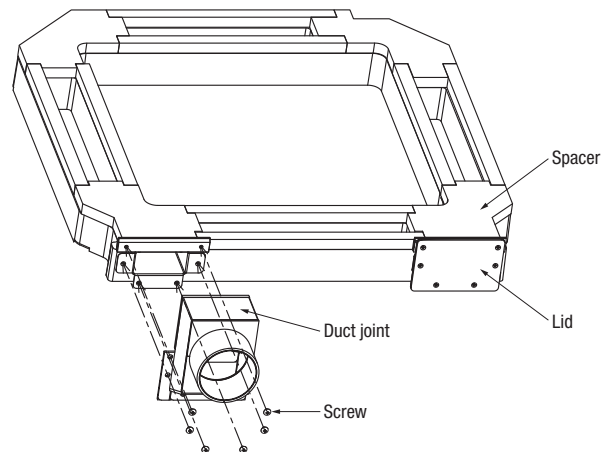

3.6 FILTER KIT (FDUM series)

PJZ012D076A 

This manual contains installation points and operating instructions for the filter kit manufactured by MHI. Carry out the work following the instructions below.

This manual also contains information on the usage after installation, so keep this manual properly with USER'S MANUAL provided with the indoor unit.



 **CAUTION**

- After unpacking, carry out this work on the ground.
- Do not carry out the work during operation, or there is a danger of being entangled in the rotating parts and getting injured.
- Clean the air filter regularly.
- Be sure to entrust qualified serviceman to performance on the air filter.
- Be sure to cut off the power and stop the unit before performing maintenance.

1. Table of filter kit parts No. and corresponding object models

	Small model	Medium model	Large model
Single type	40, 50	60, 71	100 - 140
Multi type	22 - 56	71, 90	112 - 160
Filter Kit	UM-FL1EF	UM-FL2EF	UM-FL3EF

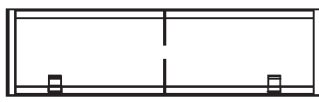
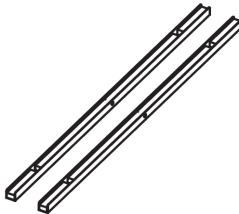
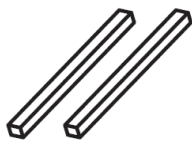
2. Parts list of filter kit

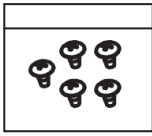
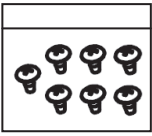
Filter	Rail	Insulation
		
1 pc.	2 pcs.	2 pcs.
Bracket	Parts set(screw)	
		
1 pc.	(small and medium model : 5 pcs.) 1 pc.	(large model : 7 pcs.)

3. Installation Points

(1) Stick the insulation on both inner sides of the duct, leaving no space up and down.

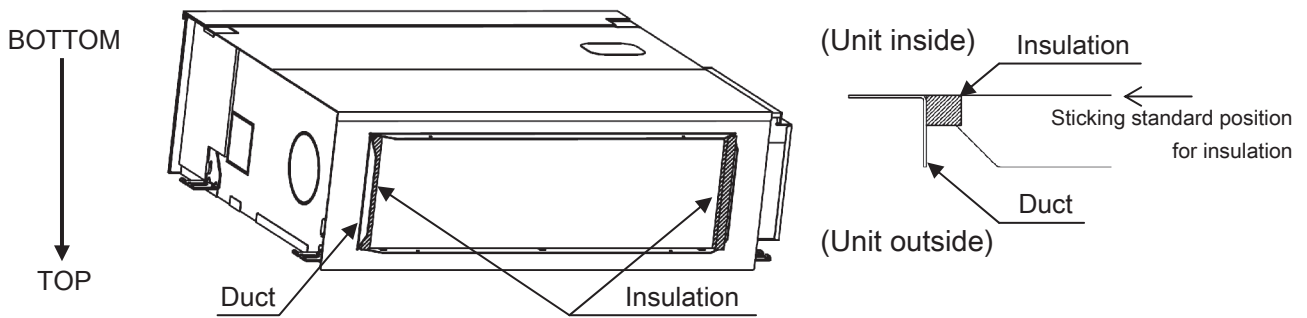

(*) After unpacking, bottom side of the unit is located at the upper side.

(2) Install the rail on both inner sides of the duct with the screw.

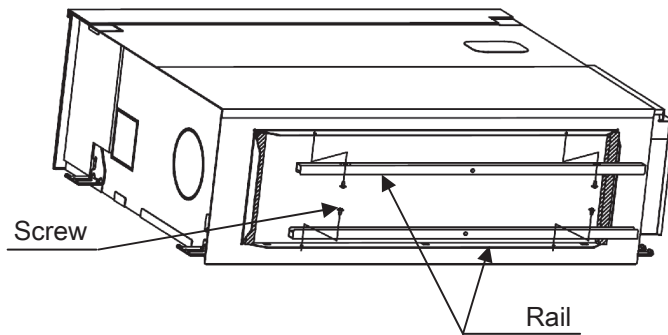

(3) Install the air filter on the rails.

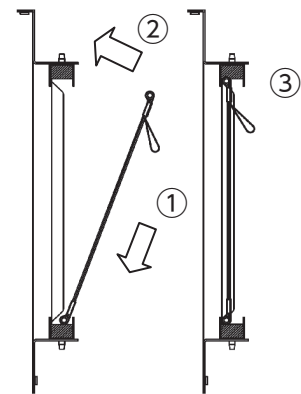
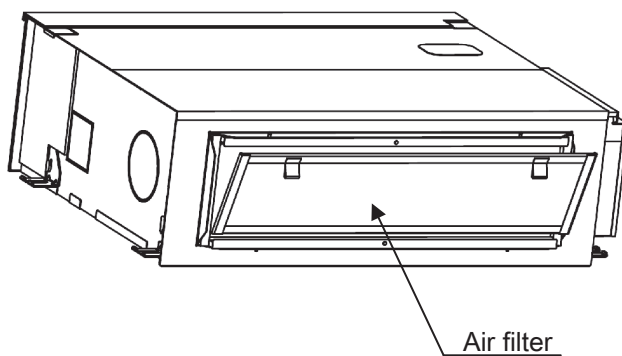

Installation procedure

(4) Install the bracket on the rail with the screw.

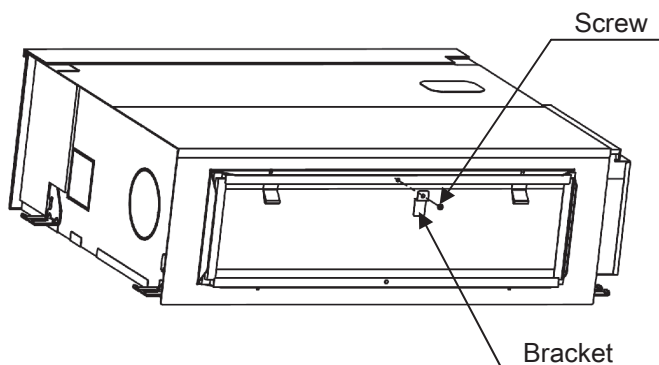

(**) When the unit is installed, bottom side of the unit is located at the lower side.

3.7 INTERFACE KIT (SC-BIKN2-E)

※ When RC-EX3A is connected, please use SC-BIKN2-E by all means.

RKZ012A099

Accessories included in package

Be sure to check all the accessories included in package.

No.	Part name	Quantity
①	Indoor unit's connection cable (cable length: 1.8m)	1
②	Wood screws (for mounting the interface: ø4x 25)	2
③	Tapping screws (for the cable clamp and the interface mounting bracket)	3
④	Interface mounting bracket	1
⑤	Cable clamp (for the indoor unit's connection cable)	1
⑥	CnT terminal connection cable (total cable length: 0.5m)	1

Safety precautions

Before use, please read these Safety precautions thoroughly before installation.

- All the cautionary items mentioned below are important safety related items to be taken into consideration, so be sure to observe them at all times.



Warning Incorrect installation could lead to serious consequences such as death, major injury or environmental destruction.

- Symbols used in these precautions



Always go along these instruction.

- After completed installation, carry out trial operation to confirm no anomaly, and ask the user to keep this installation manual in a good place for future reference.



Warnings



- **Installation must be carried out by a qualified installer.**
If you install it by yourself, it may cause an electric shock, fire and personal injury, as a result of a system malfunction.
- **Install it in full accordance with the installation manual.**
Incorrect installation may cause an electric shock, fire and personal injury.
- **Electrical work must be carried out by a qualified electrician in accordance with the technical standard for electrical equipment, the indoor wiring standard and this installation manual.**
Incorrect installation may cause an electric shock, fire and personal injury.
- **Use the specific cables for wiring. And connect all the cables to terminals or connectors securely and clamp them with cable clamps in order for external forces not to be transmitted to the terminals directly.**
Incomplete connection may cause malfunction, and lead to heat generation and fire.
- **Use the original accessories and specified components for installation.**
If the parts other than those prescribed by us are used, it may cause an electric shock, fire and personal injury.

Connecting the indoor unit's connection cable to the interface

- Remove the upper case of the interface.
 - Remove 2 screws from the interface casing before removal of upper casing.
- Connect the indoor unit's connection cable to the interface.
 - Connect the connector of the indoor unit connection cable to the connector on the interface's circuit board.
- Fix the indoor unit's connection cable with the cable clamp.
 - Cable can be brought in from the top or from the back.
 - Cut out the punch-outs for the connection cables running into the casing with cutter.
- Connect the indoor unit's connection cable to the indoor control PCB.
 - Connect the indoor unit's connection cable to the indoor control PCB securely.
 - Clamp the connection cable to the indoor control box securely with the cable clamp provided as an accessory.
 - Regarding the cable connection to the indoor unit, refer to the installation manual for indoor unit.

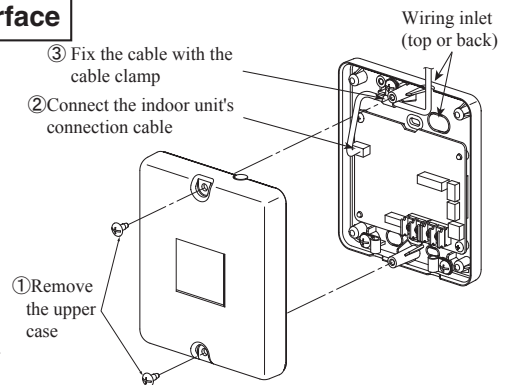

Name of each part of the interface

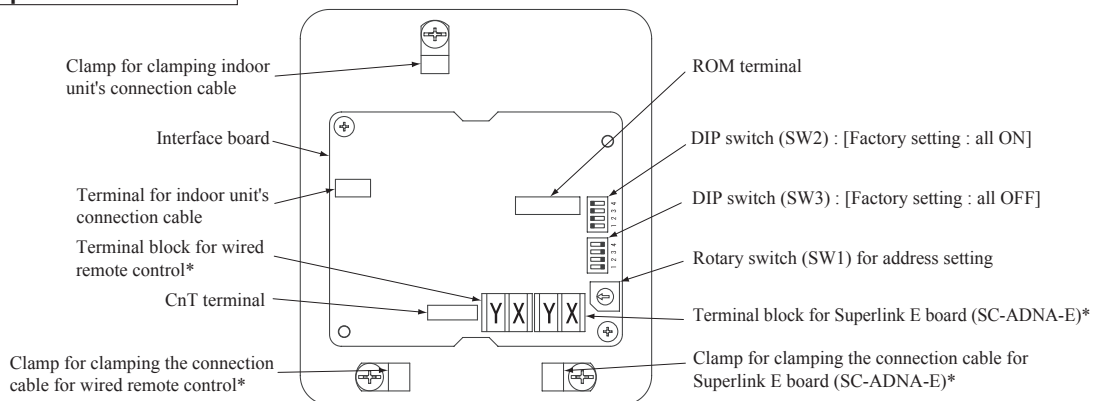

*Either the connection cables of Superlink E board (SC-ADNA-E) or of wired remote control is connectable.

Switch	Setting	Function	Switch	Setting	Function
SW2-1	ON**	CnT level input	SW2-3	ON**	External input (CnT input)
	OFF	CnT pulse input		OFF	Operation permission/prohibition (CnT input)
SW2-2	ON**	Wired remote control : Enable	SW2-4	ON**	Annual cooling : Enable***
	OFF	Wired remote control : Disable		OFF	Annual cooling : Disable***

** Factory setting

*** Indoor fan control at low outdoor air temperature in cooling

Installation of the interface

- Install the interface within the range of the connection cable length (approximately 1.3m) from the indoor unit.
 - Be sure not to extend the connection cable on site. If the connection cable is extended, malfunction may occur.
 - Fix the interface on the wall, pillar or the like.
- Don't install the interface and wired remote control at the following places.
- Places exposed to direct sunlight
 - Places near heating devices
 - High humidity places
 - Surfaces where are enough hot or cold to generate condensation
 - Places exposed to oil mist or steam directly
 - Uneven surface

Mounting the interface directly on a wall

- ① Mount the lower casing of the interface on a flat surface with wood screws provided as standard accessory.
- ② Mount the upper casing.

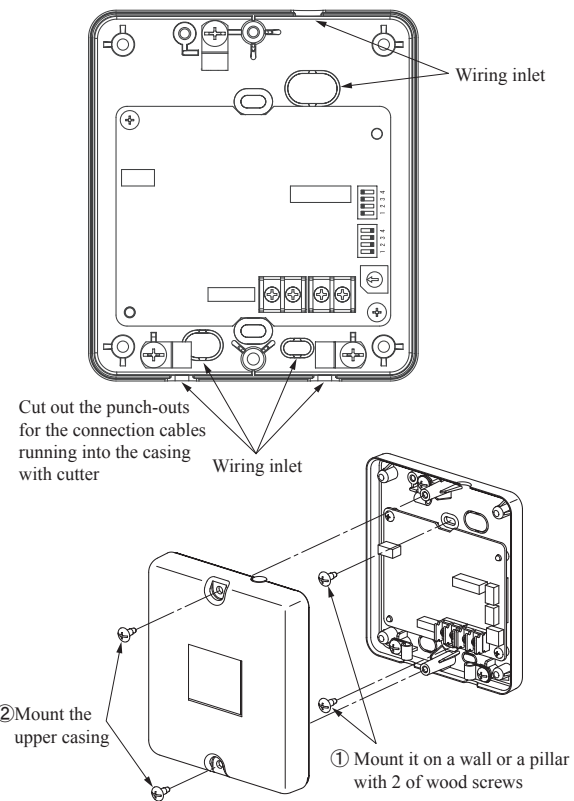

Recessing the interface in the wall

- ① Recess the electrical box (procured locally) and connection cables in the wall.
- ② Mount the lower casing of the interface to the electrical box with M4 screws (procured locally).
- ③ Mount the upper casing.

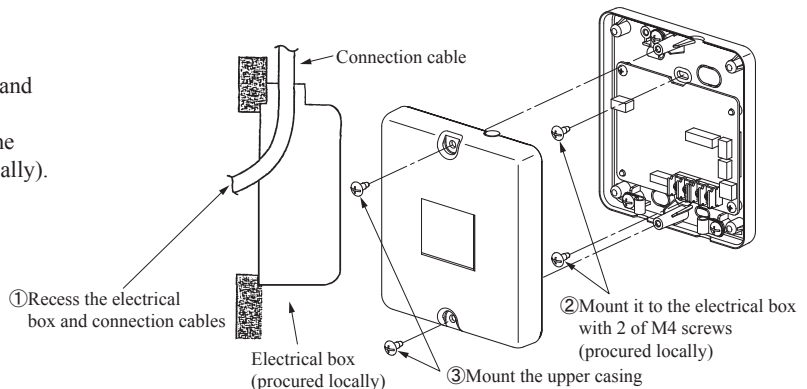

Mounting the interface with the mounting bracket

- ① Mount the upper casing.
- ② Mount the mounting bracket to the interface with tapping screws provided as standard accessory.
- ③ Mount the mounting bracket on wall or the like with wood screws provided as standard accessory.

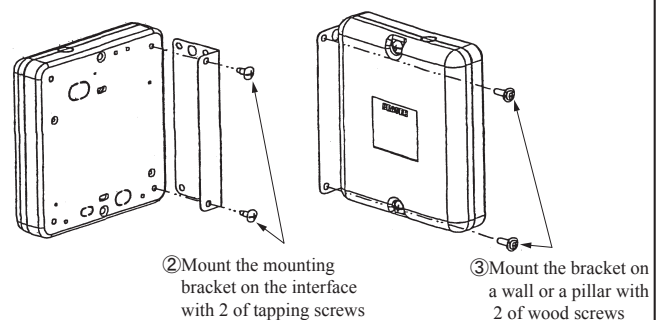

Installation check items

- Are the connection cables connected securely to the terminal blocks and connectors?
- Are the thickness and length of the connection cables conformed with the standard?

Functions of CnT connector

It is available to operate the air-conditioner and to monitor the operation status with the external control unit (remote display) by sending the input/output signal through CnT connector on the indoor control PCB.

- ① Connect a external remote control unit (procured locally) to CnT terminal.
- ② In case of the pulse input, switch OFF the DIP switch SW2-1 on the interface PCB.
- ③ When setting operation permission/prohibition mode, switch OFF the DIP switch SW2-3 on the interface PCB.

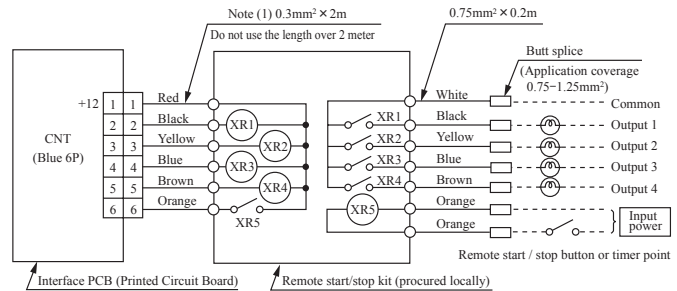

Input/Output	Function	Output signal		Content
		Relay	ON/OFF	
Output 1	Operation output	XR1	ON	During air-conditioner operation
Output 2	Heating output	XR2	ON	During heating operation
Output 3	Compressor operation output	XR3	ON	During compressor running
Output 4	Malfunction output	XR4	ON	During anomalous stop

- XR1-4 are for the DC 12V relay
- XR5 is a DC 12/24V or AC 220-240V relay
- CnT connector (local) maker, model

Connector	Molex	5264-06
Terminals	Molex	5263T

Input/Output	Function	SW2-1		SW2-3		Air-conditioner	Operation by remote control			
		Setting		Input signal						
		Setting	Setting	Level/Pulse	XR5					
Input	External control input	ON*	Level input	ON*	Level	OFF→ON	External input	ON	Allowed	
				OFF	Level	ON→OFF	Operation permission	OFF		
				ON→OFF	Operation prohibition	OFF	Not allowed			
		OFF	Pulse input	ON*	Pulse	OFF→ON	External input	OFF→ON	ON	Allowed
				OFF	Level	ON→OFF	Operation permission	ON		
				ON→OFF	Operation prohibition	OFF	Not allowed			

* Factory setting

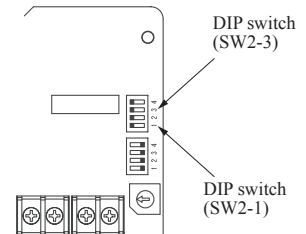

In case of the remote control (RC-EX3 or later model), the external outputs (1 – 4) and the external input can be changed using the function setting of remote control. For the setting method, refer to the installation manual. Also refer to the technical manual to know how it is adapted to the function setting for the external outputs and input, at the indoor unit side.

Connection of Superlink E board

Regarding the connection of Superlink E board, refer to the installation manual of Superlink E board.

For electrical work, power source for all of units in the Superlink system must be turned OFF.

- ① Switch ON the DIP switch SW2-2 (Factory setting: ON) on the interface PCB.

Caution: Wireless remote control attached to the indoor unit can be used in parallel, after connecting the wired remote control. However, some of functions other than the basic functions such as RUN/STOP, temperature setting, etc. may not work properly and may have a mismatch between the display and the actual behavior.

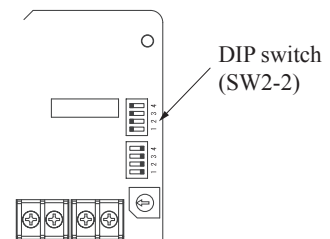

- ② Wiring connection between the interface and the Superlink E board.

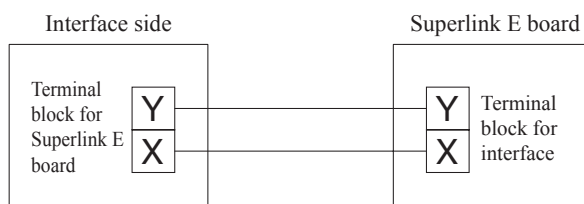

No.	Names of recommended signal wires
1	Shielded wire
2	Vinyl cabtyre round cord
3	Vinyl cabtyre round cable
4	Vinyl insulated wire vinyl sheathed cable for control

Within 200 m 0.5 mm² × 2 cores
 Within 300 m 0.75 mm² × 2 cores
 Within 400 m 1.25 mm² × 2 cores
 Within 600 m 2.0 mm² × 2 cores

- ③ Clamp the connection cables with cable clamps.

Connection of wired remote control

Regarding the connection of wired remote control, refer to the installation manual of wired remote control.

① Switch ON the DIP switch SW2-2 (Factory setting : ON) on the interface PCB.

Caution: Wireless remote control attached to the indoor unit can be used in parallel, after connecting the wired remote control. However, some of functions other than the basic functions such as RUN/STOP, temperature setting, etc. may not work properly and may have a mismatch between the display and the actual behavior.

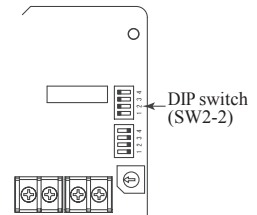

② Wiring connection between the interface and the wired remote control.

Installation and wiring of wired remote control

Ⓐ Install the wired remote control with reference to the attached installation manual of wired remote control.

Ⓑ 0.3mm² × 2 cores cable should be used for the wiring of wired remote control.

Ⓒ Maximum length of wiring is 600m.

If the length of wiring exceeds 100m, change the size of cable as mentioned below.

100m-200m: 0.5mm² × 2 cores, 300m or less: 0.75mm² × 2 cores, 400m or less: 1.25mm² × 2 cores, 600m or less: 2.0mm² × 2 cores

However, cable size connecting to the terminal of wired remote control should not exceed 0.5mm². Accordingly if the size of connection cable exceeds 0.5mm², be sure to downsize it to 0.5mm² at the nearest section of the wired remote control and waterproof treatment should be done at the connecting section in order to avoid contact failure.

Ⓓ Don't use the multi-core cable to avoid malfunction.

Ⓔ Keep the wiring of wired remote control away from grounding (Don't touch it to any metal frame of building, etc.).

Ⓕ Connect the connection cables to the terminal blocks of the wired remote control and the interface securely (No polarity).

③ Clamp the connection cables with cable clamps.

Control of multiple units by a single wired remote control

Multiple units (up to 16) can be controlled by a single wired remote control. In this case, all units connected with a single wired remote control will operate under the same mode and same setting temperature.

① Connect all the interface with 2 cores cables of wired remote control line.

② Set the address of indoor unit for remote control communication from "0" to "F" with the rotary switch SW1 on the interface PCB.

③ After turning the power ON, the address of indoor unit can be displayed by pressing [AIR CON No.] button on the wired remote control.

Make sure all indoor units connected are displayed in order by pressing [▲] or [▼] button.

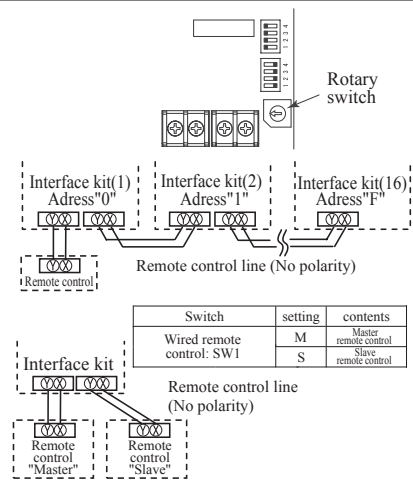

Master/Slave setting wired when 2 of wired remote control are used

Maximum two wired remote control can be connected to one indoor unit (or one group of indoor units)

① Set the DIP switch SW1 on the wired remote control to "Slave" for the slave remote control. (Factory setting : Master)

○ Caution : Remote control sensor of the slave remote control is invalid.

● When using the wireless remote control in parallel with the wired remote control;

Since temperature setting range of wired remote control is different from that of wireless remote control, please adjust the setting range of wired remote control to be the same setting range of wireless remote control by following procedure. (The set temperature may not be displayed correctly on the wireless remote control, unless change of temperature setting range is done.)

Changing procedure of temperature setting range is as follows.

How to set upper and lower limit of temperature setting range

1. Stop the air-conditioner, and press [○] (SET) and [◀] (MODE) button at the same time for 3 seconds or more.

The indication changes to "FUNCTION SET ▼"

2. Press [▼] button once, and change to the "TEMP RANGE ▲" indication.

3. Press [○] (SET) button, and enter the temperature range setting mode.

4. Confirm that the "Upper limit ▼" is shown on the display.

5. Press [○] (SET) button to fix.

6. ① Indication: "UPPER 28°C ▼ ▲"

② Select the upper limit value 30°C with temperature setting button [▲]. "UPPER 30°C ▼" (blinking)

③ Press [○] (SET) button to fix. "UPPER 30°C" (Displayed for two seconds)

After the fixed upper limit value displayed for two seconds, the indication will return to "UPPER LIMIT ▼".

7. Press [▼] button once, "LOWER LIMIT ▲" is selected, press [○] (SET) button to fix.

① Indication: "LOWER 20°C ▼ ▲"

② Select the lower limit value 18°C with temperature setting button [▼]. "LOWER 18°C ▲" (blinking)

③ Press [○] (SET) button to fix. "LOWER 18°C" (Displayed for two seconds)

After the fixed lower limit value displayed for two seconds, the indication will return to "LOWER LIMIT ▼".

8. Press [ON/OFF] button to finish.

Temperature setting range

Mode	Temperature setting range
Cooling, Heating, Dry, Auto	18-30°C

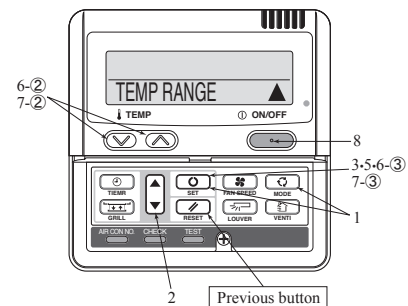

- It is possible to quit in the middle by pressing [ON/OFF] button, but the change of setting is incompleated.
- During setting, if pressing [RESET] button, it returns to the previous screen.

3.8 SUPERLINK E BOARD (SC-ADNA-E)

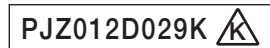

- Read and understand the instructions completely before starting installation.
- Refer to the instructions for both indoor and outdoor units.

Safety precautions

- Carefully read "Safety precautions" first. Follow the instructions for installation.
- Precautions are grouped into "Warning⚠" and "Caution⚠". The "Warning⚠" group includes items that may lead to serious injury or death if not observed. The items included in the "Caution⚠" group also may lead to serious results under certain conditions. Both groups are crucial for safety installation. Read and understand them carefully.
- After installation, conduct the test operation of the device to check for any abnormalities. Describe how to operate the device to the customer following the installation instruction manual. Instruct the customer to keep this installation instruction for future reference.

⚠Warning

- This device should be installed by the dealer where you purchase the device or a licensed professional shop. If the device is incorrectly installed by the customer, it may result in electric shock or fire.
- Install the device carefully following the installation instruction. If the device is incorrectly installed, it may result in electric shock or fire.
- Use the accessory parts and specified parts for installation. If any parts that do not match the specifications are used, it may result in electric shock or fire.
- A person with the electrical service certification should conduct the service based on the "Technical standards for electrical facilities", "Electrical Wiring Code", and the installation instruction. If the work is done incorrectly, it may result in electric shock or fire.
- Wiring should be securely connected using the specified types of wire. No external force on the wire should be applied to any terminals. If a secure connection is not achieved, it may result in electric shock or fire.



⚠Caution

- Provide ground connection.
The ground line should never be connected to the gas supply piping, the water supply piping, the lightning conductor rod, nor the telephone ground. If the grounding is improper, it may result in electric shock.
- Do not install the device in the following locations.
 1. Where there is mist/spray of oil or steam such as kitchens.
 2. Where there is corrosive gases such as sulfuric acid gas.
 3. Where there is a device generating electromagnetic waves.
These may interfere with the control system resulting in the device becoming uncontrollable.
 4. Where flammable volatile materials such as paint thinner and gasoline may exist or where they are handled. This may cause a fire.

1 Application

Indoor-to-outdoor three core communication specification type 3 (since October 2007)

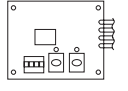
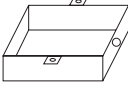
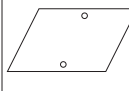
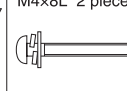
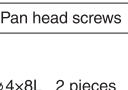
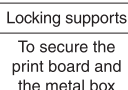
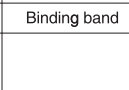
2 Accessories

SL E board 	Metal box 	Metal cover 	Screw for ground M4x8L 2 pieces 
Pan head screws φ4x8L 2 pieces 	Locking supports To secure the print board and the metal box Made of nylon 4 pieces 	Binding band 	Grommet 

5 Connection outline

Note for setting the address

- Set the address between 00 and 47 for the previous Superlink connection and between 000 and 127 for the new Superlink connection. (*1)
- Do not set the address overlapping with those of the other devices in the network. (The default is 000)

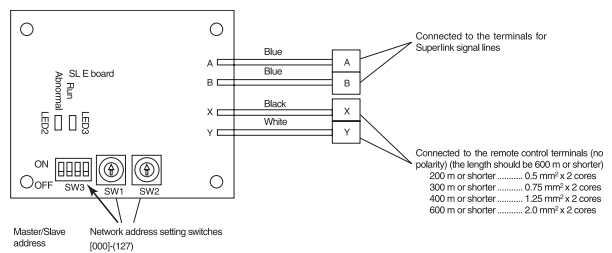

(*1) Whether the actual link is either the new Superlink or the previous Superlink depends on the models of the connected outdoor and indoor units. Consult the agent or the dealer.

3 Function

Allowing the central control SL1N-E, SL2NA-E, and SL4-AE/BE to control and monitor the commercial air-conditioner unit.

4 Control switching

Settings can be changed by the DIP switch SW3 on the SL E board as in the following.

Switch	Symbol	Switch	Remarks
SW3	1	ON	Master
		OFF (default)	Slave
	2	ON	Fixed previous protocol
		OFF (default)	Automatic adjustment of Superlink protocol
	3	ON	Indicates the forced operation stop when abnormality has occurred.
		OFF (default)	Indicates the status of running/stop as it is, when abnormality has occurred.
	4	ON	The hundredth address activated "1"
		OFF (default)	The hundredth address activated "0"

Signal line specification

Communication method	Previous Superlink	New Superlink
Line type	MVVS	MVVS
Line diameter	0.75 - 1.25mm ²	0.75/1.25mm ²
Signal line (total length)	up to 1000m	up to 1500/1000m (*2)
Signal line (maximum length)	up to 1000m	up to 1000m

(*2) Up to 1500 m for 0.75 mm², and up to 1000 m for 1.25 mm². Do not use 2.0 mm². It may cause an error.

(*3) Connect grounding on both ends of the shielding wire. For the grounding method, refer to the section "6 Installation".

- (1) Set the Superlink network address with SW1 (tens place), SW2 (ones place), and SW3 (hundreds place).
- (2) Set the SL E board SW3-1 to be ON (Master) when using this without any remote control (no wired remote controller nor wireless remote control).
- (3) Set up the plural master/slave device using the DIP switches on the indoor unit board.
- (4) Set up the remote control master/slave device using the slide switch on the remote control board.
- (5) Set up "0" to "F" using the address rotary switch on the indoor unit board when controlling the indoor unit with the multiple remote control.

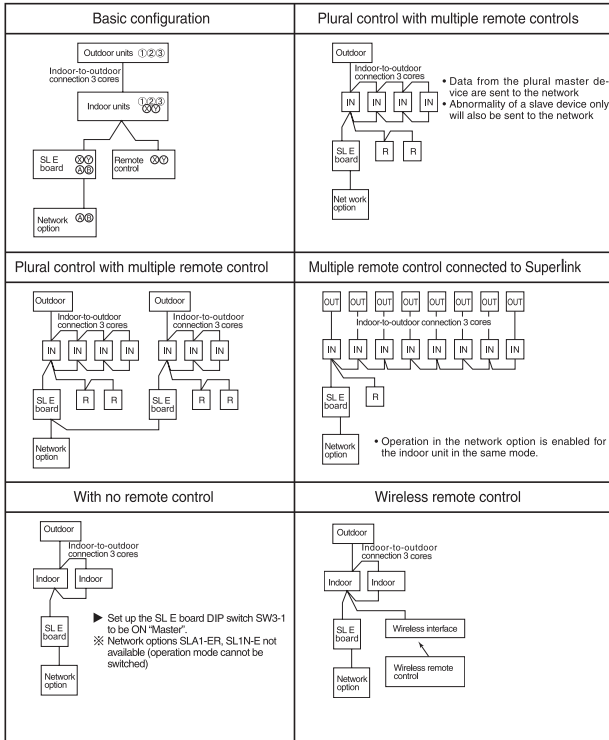

Connect grounding. Connect grounding for the power line to Ground ①, and grounding for the signal line to Ground ② or to the Ground on the indoor unit control box.

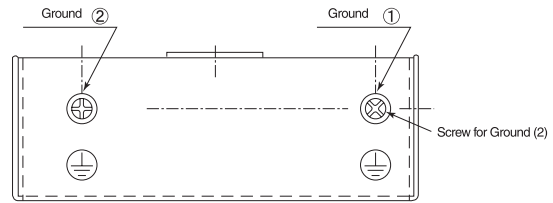

2. When connecting to the indoor unit control box (ceiling-concealed type and FDT type only):
 - (1) Mount the SL E board in the control box using the locking supports.
 - (2) Remove 6 bands from the box and put the wiring through the bands to be secured.

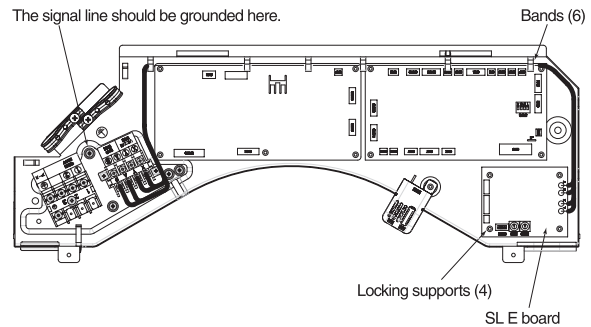

Electrical shock hazard! make sure to turn the power off for servicing. Be cautious so that no abnormal force should be applied to the wiring. Do not let the SL E board hung by the wiring. Do not damage the board with a screw driver. The board is sensitive to static electricity. Release the static electricity of your body before servicing. (You can do this by touching the control board which is grounded).

Location of installation

Install the device at the location where there are no electromagnetic waves nor where there is water and dust. The specified temperature range of the device is 0 to 40°C. Install the device at the location where the ambient temperature stays within the range. If it exceeds the specification, make sure to provide solution such as installing a cooling fan. When used outside of the range, it may cause abnormal operation.

6 Installation

1. When using the metal box (mounted on the indoor unit / mounted on the back of the remote control):
 - (1) Mount the SL E board in the metal box using the locking supports.
 - (2) Wiring should go through the provided grommet since then through the wiring to the hole on the Metal box. Secure the grommet after inserting the grommet into the Metal box as shown in below figure, then tie the wiring at the outlet of the unit using a binding band.

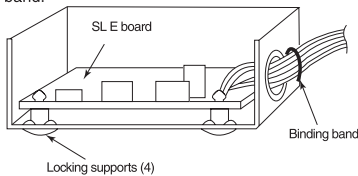

▲ When installed outside the indoor unit, put the metal cover on.

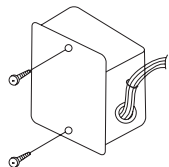

▲ When installed on the back of the remote control, mount it directly on the remote control bottom case.

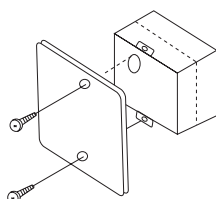

7 Indicator display

Check the LED 3 (green) and LED 2 (red) on the SL E board for flashing.

SL E board LEDs		Inspection mode	Display on the integrated network control device
Red	Green		
Off	Flashing	Normal communication	
Off	Off	<ul style="list-style-type: none"> Disconnection in the remote control communication line (X or Y) Short-circuit in the remote control communication line (between X and Y) Faulty indoor unit remote control power Faulty remote control communication circuit Faulty CPU on SL E board 	No corresponding unit number
One flash	Flashing	<ul style="list-style-type: none"> Disconnection in the Superlink signal line (A or B) Short-circuit in the Superlink signal line (between A and B) Faulty Superlink signal circuit 	
Two flashes	Flashing	<ul style="list-style-type: none"> Faulty address setting for the SL E board (Set up the address for previous SL E board : more than 48 new SL E board : more than 128) 	
Three flashes	Flashing	<ul style="list-style-type: none"> SL E board parent not set up when used without a remote control Faulty remote control communication circuit 	E1
Four flashes	Flashing	<ul style="list-style-type: none"> Address overlapping for the SL E board and the Superlink network connected indoor unit 	E2
Off	Flashing	<ul style="list-style-type: none"> Number of connected devices exceeds the specification for the multiple indoor unit control 	E10

HYPER INVERTER PACKAGED AIR-CONDITIONERS



MITSUBISHI HEAVY INDUSTRIES THERMAL SYSTEMS, LTD.

2-3, Marunouchi 3-chome, Chiyoda-ku, Tokyo, 100-8332, Japan
<http://www.mhi-mth.co.jp/en/>

Because of our policy of continuous improvement, we reserve the right to make changes in all specifications without notice.

© Copyright MITSUBISHI HEAVY INDUSTRIES THERMAL SYSTEMS, LTD.