

MPXPRO

Electronic controller

CAREL



ENG User manual

**LEGGI E CONSERVA
QUESTE ISTRUZIONI**
→ **READ AND SAVE
THESE INSTRUCTIONS** ←



High Efficiency Solutions

WARNING



CAREL developed its products thanks to the several years of experience in the HVAC field, continuous investment in technological innovation of the product, rigorous quality procedures and processes with in-circuit and function tests on 100% of its production, as well as the most innovative production technologies available on the market. CAREL and its branch offices/affiliates do not guarantee, in any case, that all the aspects of the product and the software included in the product will respond to the demands of the final application, even if the product is built according to state-of-the-art techniques.

The client (builder, developer or installer of the final equipment) assumes every responsibility and risk relating to the configuration of the product in order to reach the expected results in relation to the specific final installation and/or equipment. CAREL, in this case, through specific agreements, can intervene as consultant for the positive result of the final start-up machine/application, but in no case can it be held responsible for the positive working of the final equipment/apparatus.

The CAREL product is a state-of-the-art product, whose operation is specified in the technical documentation supplied with the product or can be downloaded, even prior to purchase, from the website www.carel.com.

Each CAREL product, in relation to its advanced technological level, needs a phase of definition / configuration / programming / commissioning so that it can function at its best for the specific application. The lack of such phase of study, as indicated in the manual, can cause the final product to malfunction of which CAREL cannot be held responsible.

Only qualified personnel can install or carry out technical assistance interventions on the product.

The final client must use the product only in the manner described in the documentation related to the product itself.

Without excluding proper compliance with further warnings present in the manual, it is stressed that in any case it is necessary, for each CAREL product:

- Not allow the electronic circuits getting wet. Rain, humidity and all types of liquids or condensate contain corrosive mineral substances that can damage the electrical circuits. In any case, the product should be used and stored in environments that respect the temperature and humidity limits specified in the manual;
- Not to install the device in a particularly hot environments. Temperatures that are too high can shorten the duration of the electronic devices, damaging them and distorting or melting the parts in plastic. In any case, the product should be used and stored in environments that respect the temperature and humidity limits specified in the manual;
- Not to try to open the device in any way different than that indicated in the manual;
- Not to drop, hit or shake the device, because the internal circuits and mechanisms could suffer irreparable damage.
- Not to use corrosive chemical products, aggressive solvents or detergents to clean the device;
- Not to use the product in application environments different than those specified in the technical manual.

All the above reported suggestions are also valid for the control, serial boards, programming keys or however for any other accessory in the CAREL product portfolio.

CAREL adopts a continuous development policy. Therefore, CAREL reserves the right to carry out modifications and improvements on any product described in this document without prior notice.

The technical data in the manual can undergo modifications without forewarning.

The liability of CAREL in relation to its products is specified in the CAREL general contract conditions, available on the website www.carel.com and/or by specific agreements with customers; specifically, to the extent where allowed by applicable legislation, in no case will CAREL, its employees or subsidiaries be liable for any lost earnings or sales, losses of data and information, costs of replacement goods or services, damage to things or people, downtime or any direct, indirect, incidental, actual, punitive, exemplary, special or consequential damage of any kind whatsoever, whether contractual, extra-contractual or due to negligence, or any other liabilities deriving from the installation, use or impossibility to use the product, even if CAREL or its subsidiaries are warned of the possibility of such damage.

DISPOSAL



INFORMATION FOR THE USERS REGARDING THE CORRECT HANDLING OF WASTE ELECTRIC AND ELECTRONIC EQUIPMENT (WEEE)

With reference to European Parliament and Council Directive 2002/96/EC issued on 27 January 2003 and the related national implementation legislation, please note that:

- WEEE cannot be disposed of as municipal waste, said waste must be collected separately;
- the public or private waste collection systems defined by local legislation must be used. Moreover, the equipment can be returned to the distributor at the end of its working life when buying new equipment;
- this equipment may contain dangerous substances: improper use or incorrect disposal of such may have negative effects on human health and on the environment;
- the symbol (crossed-out wheeled bin) shown on the product or on the packaging and on the instruction sheet indicates that the equipment has been introduced onto the market after 13 August 2005 and that it must be disposed of separately;
- in the event of illegal disposal of electrical and electronic waste, the penalties are specified by local waste disposal legislation.

Materials warranty: 2 years (from the date of production, excluding consumables).

Type-approval: the quality and safety of CAREL S.P.A. products are guaranteed by the design system and ISO 9001 certified production.

**NO POWER
& SIGNAL
CABLES
TOGETHER**

READ CAREFULLY IN THE TEXT!

WARNING: separate the probe cables and the digital input cables as much as possible from the inductive load and power cables to prevent possible electro-magnetic interference. Never introduce power cables and signal cables (including those of electric control board) into the same cable troughs.

HACCP: caution



The Food Safety programs based on HACCP procedures and on certain national standards, require that the devices used for food preservation are periodically checked to make sure that the measuring errors are within the allowed limits of the application of use.

Carel recommends compliance with the indications of European standard "Temperature recorders and thermometers for transport, storage and distribution of chilled, frozen, deep-frozen/ quick-frozen food and ice cream – PERIODIC VERIFICATION", EN 13486 -2001 (or subsequent updates) or similar standards and prescriptions applicable in the country of use.

The manual contains further indications regarding technical feature, proper installation and configuration of the product.



HACCP International Food Safety Certification Systems
"Food Safe Equipment Material and Services"
 Certificato I-PE-705-CIS-RG-01b (valid until 31/12/2015)
<http://www.haccp-international.com/>

This product is approved for the use in food preservation applications in compliance with the strictest standards in the sector.

Content

1. INTRODUCTION	7	6. ADVANCED FUNCTIONS	37
1.1 Models	8	6.1 Probes (analogue inputs)	37
1.2 Functions and main characteristics	8	6.2 Digital inputs	38
2. INSTALLATION	11	6.3 Analogue outputs	38
2.1 MPXPRO: DIN rail assembly and dimensions	11	6.4 Digital outputs	39
2.2 Main board: description of the terminals	12	6.5 Control	39
2.3 E ² V driver expansion board (MX3OPSTP**): terminals and connections	13	6.6 Compressor	42
2.4 PWM driver expansion board (MX3OPPWM**): terminals and connections	13	6.7 Defrost	42
2.5 Expansion board 0 to 10 Vdc output (MX*OPA10**): terminals and connections	13	6.8 Evaporator fans	44
2.6 Functional diagrams	14	6.9 Electronic valve	44
2.7 Connecting the MCHRTF**** module	14	6.10 Protectors	47
2.8 General connection diagram	15	6.11 Refrigerant flow control	49
2.9 Installation	16	7. OPTIONAL CONFIGURATIONS	50
2.10 Programming key (copy set-up)	16	7.1 Other configuration parameters	50
2.11 Commissioning tool (VPM- Visual Parameter Manager)	17	8. TABLE OF PARAMETERS	51
2.12 Setting the default parameters/loading the parameter sets	17	9. ALARMS AND SIGNALS	56
3. USER INTERFACE	18	9.1 Signals	56
3.1 User terminal and remote display	18	9.2 Alarms	56
3.2 Keypad	18	9.3 Display alarm log	56
3.3 Programming	19	9.4 HACCP alarms and display	56
3.4 Ex.: setting current date/time and day/night time bands	20	9.5 Alarm parameters	58
3.5 Copy parameters from Master to Slave (Upload)	21	9.6 HACCP alarm parameters and activating monitoring	59
3.6 Using the remote control (accessory)	21	10. TECHNICAL SPECIFICATIONS	60
4. COMMISSIONING	23	10.1 Cleaning the terminal	61
4.1 Configuration	23	10.2 Purchase codes	61
4.2 Recommended initial configuration	23	10.3 Food safety - HACCP	62
4.3 Guided commissioning procedure (user terminal/remote display)	24		
4.4 Checks after commissioning	25		
5. BASIC FUNCTIONS	26		
5.1 Probes (analogue inputs)	26		
5.2 Digital inputs	27		
5.3 Analogue outputs	29		
5.4 Digital outputs	30		
5.5 Control	31		
5.6 Defrost	32		
5.7 Evaporator fans	35		
5.8 Electronic valve	36		

NEW FEATURES INTRODUCED IN VERSION 4.0/4.2 (see technical leaflet)

New functions

1. pressure range in psig extended to 999
2. percentage of valve opening can be set during defrost
3. timer function to maintain the status of a supervisor input or to configure a timed output
4. refrigerant flow control
5. support extended to cover 25 refrigerants and possibility to enter a custom P/T curve - from FW 4.2: 40 refrigerants
6. change configuration set from supervisor and digital input
7. independent delay for AL2 and AH2 (high and low temperature alarms for the second set point)
8. independent delay for the door open alarm and resumption of control
9. settable delay to switch off the light after closing the door
10. new function for opening the door without interrupting control
11. possibility to configure the logic of the digital inputs, NO or NC
12. new Clean and Standby operating status, in addition to ON and OFF
13. additional Modbus mapping for fast reading of operating variables
14. improved Smooth Lines control
15. optional network defrost
16. improved management of the high temperature alarm when opening the door
17. added management about condensate drain heaters
18. from FW 4.2: for A4, A5, A10, A11, A12 par. it is function 15 added

Functions no longer included:

1. monitoring and logging of a selected probe
2. light sensor management
3. configuration retained following update from previous versions to 3.3
4. display of slave operation on master display (the slave parameters can still be set from the master terminal)
5. parameter /to that specifies whether a display or terminal is connected (fixed automatic recognition)
6. commissioning via tLAN from front panel
7. from FW 4.2: NTC L243 removed

FW 4.2 = It is NOT AVAILABLE for MX10***** codes

1. INTRODUCTION

MPXPRO is an electronic controller for the complete and advanced management of stand-alone or multiplexed showcases or cold rooms, with or without built-in electronic expansion valve driver. It is designed for DIN rail assembly and comes with plug-in screw terminals. The controller can manage a local Master-Slave network with a maximum of 6 units (1 Master and 5 Slaves). Each controller can have its own display (read only) and/or user terminal (display plus keypad for programming), or alternatively the user terminal can be connected to the Master controller which then displays the parameters for all controllers connected in the network. The platform includes a wide range of models, differing in terms of type of controller (Master or Slave), the number of relay outputs available (3 or 5 on the Slave controller), the type of probes that can be connected (NTC only and 0 to 5 V ratiometric or NTC/PTC/PT1000/NTC L243, 0 to 5 V ratiometric and active 4 to 20 mA, 0 to 10 V), the type of built-in driver (for CAREL stepper or PWM electronic expansion valve), whether or not there are two PWM outputs on the main board, and whether or not there is a 0 to 10 Vdc output on the driver board. See the table below.

Main features:

- compact structure, with built-in driver for CAREL stepper or PWM valve;
- Ultracap technology for emergency closing in the event of mains power failure (no solenoid valve is required if the EEV valve is installed in direct way and the size is smaller than or equal to E3V45)
- Built-in switching power supply for stepper valve option (external transformer no longer required)
- Valve cable length extended to max 50m
- Smooth Lines function (from version 3.2): to modulate evaporator capacity based on actual cooling demand
- Display and master/slave network cable length extended to max 100 m
- advanced superheat control with protection for low superheat (LowSH), low evaporation temperature (LOP), high evaporation temperature (MOP), low suction temperature (LSA);
- defrost activated from the keypad, digital input, network control from Master, supervisor;

- management of various types of defrost, on one or two evaporators: heater, natural (stop compressor), hot gas;
- smart defrost functions;
- coordinated network defrosts;
- light and showcase curtain management;
- anti-sweat heater modulation;
- evaporator fan speed modulation;
- remote control (accessory) for commissioning and programming;
- VPM program (Visual Parameter Manager), installed on a personal computer, for managing parameters and testing the controller;
- possibility to display and set the Slave parameters from the Master;
- propagation of digital input from Master to Slave;
- display Slave alarms on the Master;
- sharing of one or more network probes (e.g. network pressure probe);
- management of network or local solenoid valve;
- remote management of Master light and AUX outputs on Slave;
- upload parameters from Master to Slaves;
- Master as gateway to supervisor for all Slaves;
- management of HACCP alarms.

Installation in direct way:

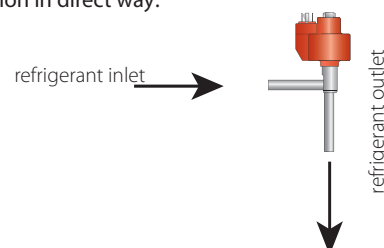

1.1 Models

The LIGHT version is supplied without the plastic side cover, it is not possible to install the driver board for expansion valves and it is available only in multiple packages without connector kit. The new features introduced in version 4.0 are not available on the LIGHT version.

The following table shows the models and the main features, also see paragraph 10.2:

Light Version

Model	Code	Master/Slave	rel.	Type of relay	RS485 & RTC Board	Features							
						Probe usable				2 PWM output	E ² V driver & 0...10 Vdc output	PWM driver & 0...10 Vdc output	0...10 Vdc output
						NTC	PTC, Pt1000, NTC L243	Ratiometric probe 0...5 Vdc	Active probe 0...10 Vdc 4...20 mA				
LIGHT	MX10M00E11	Master	5	8A-2HP-16A-8A-8A	Y(*)	YES	NO	YES	NO	NO	NO	NO	NO
	MX10S00E11	Slave	5	8A-2HP-16A-8A-8A	I	YES	NO	YES	NO	NO	NO	NO	NO
	MX10S10E11	Slave	3	8A-0-16A-0-8A	I	YES	NO	YES	NO	NO	NO	NO	NO

Tab. 1.a

Standard Version

Model	Code	Master/Slave	rel.	Type of relay	RS485 & RTC Board	Features							
						Probe usable				2 PWM output	E ² V driver & 0...10 Vdc output	PWM driver & 0...10 Vdc output	0...10 Vdc output
						NTC	PTC, Pt1000, NTC L243	Ratiometric probe 0...5 Vdc	Active probe 0...10 Vdc 4...20 mA				
FULL	MX30M21H00	Master	5	8A-2HP-16A-8A-8A	Y(*)	YES	YES	YES	YES	Y	I	I	I
	MX30S21H00	Slave	5	8A-2HP-16A-8A-8A	I	YES	YES	YES	YES	Y	I	I	I
	MX30S31H00	Slave	3	8A-0-16A-0-8A	I	YES	YES	YES	YES	Y	I	I	I
FULL + E ² V	MX30M25H00	Master	5	8A-2HP-16A-8A-8A	Y(*)	YES	YES	YES	YES	Y	Y	I	NO
	MX30S25H00	Slave	5	8A-2HP-16A-8A-8A	I	YES	YES	YES	YES	Y	Y	I	NO
FULL + PWM	MX30M24H00	Master	5	8A-2HP-16A-8A-8A	Y(*)	YES	YES	YES	YES	Y	I	Y	NO
	MX30S24H00	Slave	5	8A-2HP-16A-8A-8A	I	YES	YES	YES	YES	Y	I	Y	NO

Tab. 1.b

(Y: fitted, I: can be fitted)

(*) The Master controllers have the clock (RTC) and the RS485 interface already fitted, the Slave controllers can become Masters by fitting the MX30P48500 card (accessory) and setting a parameter (In). A Master controller can become a Slave controller by simply setting the parameter (In).



Note: The code identifies the type of controller and outputs: the fifth letter, M or S, represents a Master or Slave controller respectively; the seventh letter:

- 0= main board, driver board not pre-installed, NTC and 0 to 5 Vdc ratiometric probe only;
- 1= full optional board with 2 PWM outputs, 12 Vdc (max 20 mA), driver board not pre-installed, possibility to connect, as desired, NTC, PTC, PT1000, NTC L243 probes, 0 to 5 Vdc ratiometric probes, 0 to 10 Vdc or 4 to 20 mA active probes
- 4= full optional board with 2 PWM outputs, 12 Vdc (max 20 mA), PWM driver board pre-installed and including the 0 to 10 Vdc output, all types of probes can be connected;
- 5= full optional board with 2 PWM outputs, 12 Vdc (max 20 mA), E²V driver board pre-installed and including the 0 to 10 Vdc output, all types of probes can be connected.

1.2 Functions and main characteristics

MPXPRO has been designed to offer maximum installation flexibility and significant energy saving when fitted with the CAREL E2V or PWM electronic expansion valve driver. It features 7 analogue inputs for probes and 5 digital inputs, configurable by parameter. The following probes can be used: saturated evaporation pressure and superheated gas temperature probe, required for superheat control, outlet, intake and defrost probe for showcase temperature control, defrost probe for the second evaporator, two auxiliary monitoring probes, ambient temperature probe, glass temperature sensor and humidity probe to prevent the showcase windows from misting. In the later case the PWM outputs can be used either to control the glass heaters or the evaporator fans for air circulation. If the stepper expansion valve is not used, a second defrost probe can be installed to manage the defrost on a second evaporator. The 5 digital outputs (relays) can control the compressor/solenoid valve, evaporator fans, defrost, light and alarm. The digital inputs can be used for switching between day and night, for the defrost calls, for the door or curtain switch or to activate alarms. By creating a Master/Slave network, a series of functions can be coordinated, such as defrosts, network solenoid valve management, sharing of the pressure probe, and sharing of control status.

Example of application on vertical showcase:

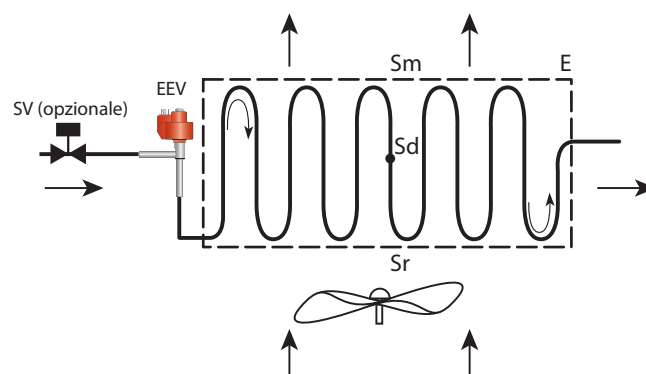

Fig. 1.a

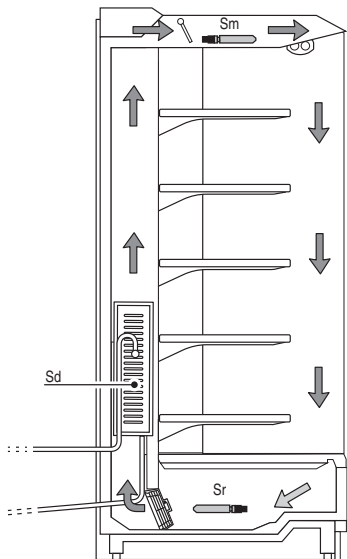

Fig. 1.b

Key:

- | | | | |
|----|----------------|-----|----------------------------|
| Sm | Outlet probe | Sr | Intake probe |
| Sd | Defrost probe | E | evaporator |
| SV | Solenoid valve | EEV | electronic expansion valve |

Below is a description of the series of components and accessories in the MPXPRO range:

Master board (MX30M***)**

Fitted with clock (RTC) and RS485 card, this can independently manage a refrigeration unit, synchronise events over a LAN and connect to a CAREL or Modbus® supervisory network. Plastic spacers are provided for fitting the for electronic valve driver (EEV) expansion board or the 0 to 10 Vdc output expansion board.



Fig. 1.c

Slave board (MX30S***)**

Without clock (RTC) and RS485 card, these can manage a refrigeration unit without the supervisor and clock functions. Slave boards can be converted into Master boards by fitting in place (see photo) the RTC and RS485 interface card (MX30P48500) and setting a parameter (In). Plastic spacers are provided for fitting the EEV driver expansion board or the 0 to 10 Vdc output board.



Fig. 1.d

Master/Slave boards (MX30*25H00)

With 2 PWM outputs and E2V driver board with 0 to 10 Vdc output incorporated.



Fig. 1.e

Master/Slave boards (MX30*24H00)

With 2 PWM outputs and PWM driver board with 0 to 10 Vdc output incorporated.



Fig. 1.f

Stepper EEV expansion board (MX30PST*).**

Optional board for controlling a CAREL E²V electronic expansion valve driven by stepper motor. Model MX30PSTP0* also has a 0 to 10 V modulating output for controlling the evaporator fans and anti-sweat heaters.

Available in version with ultracap technology to ensure the electronic valve closing in the event of power failure to avoid the installation of liquid solenoid valve.



Fig. 1.g

PWM (Pulse-Width Modulation) EEV expansion board (MX30PPWM)**

Optional board for controlling an AC or DC PWM electronic expansion valve. Model MX30PPWM0* also has a 0 to 10 V modulating output for controlling the evaporator fans and anti-sweat heaters.



Fig. 1.h

0 to 10 Vdc expansion board (MX*OPA10)**

Optional board used to manage the evaporator fans and anti-sweat heaters with a 0 to 10 Vdc control signal.



Fig. 1.i

RTC and RS485 interface card (MX3OP48500)

Optional card that adds the clock (RTC) and RS485 interface (CAREL and Modbus® protocol) functions to the MPXPRO Slave controllers, making them MPXPRO Master controllers.

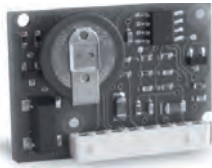

Fig. 1.j

User terminal (IR00UG*300) and remote display (IR00XG*300)

The user terminal includes the display and the keypad, featuring 4 buttons that, pressed alone or in combination, are used to program the controller. The remote display is used to show system variables. Both devices are available in two versions, with or without infrared receiver and commissioning port.

user terminal

remote display



Fig. 1.k



Fig. 1.l

USB/RS485 converter (CVSTDUMOR0)

The USB/RS485 converter is an electronic device that is used to interface an RS485 network to a personal computer using the USB port.



Fig. 1.m

USB/I2 Cconverter (IROPZPRG00)

Converter used to connect a personal computer to an MXOPZKEYA0 programming key, so as, using the VPM program (Visual Parameter Manager), to read, edit and write the parameters. In turn the programming key can be used to program other controllers or read the parameters, for example to copy the parameter settings entered on the keypad of other controllers.



Fig. 1.n

Programming key (MXOPZKEYA0/IROPZKEYA0)

Fitted with interchangeable connectors, the MXOPZKEYA0 programming key for MPXPRO is used to copy the complete set of parameters, storing up to six different control parameter configurations. Below is the table of compatibility with MPXPRO firmware versions.



Fig. 1.o

Programming key	MPXPRO firmware version	Sets of parameters available
MXOPZKEYA0	≥ 2.1	6
IROPZKEYA0	≤ 1.2	2

Tab. 1.c

VPM programming tool (Visual Parameter Manager)

The program can be downloaded from <http://ksa.carel.com>. Once running on the computer the tool can be used to commission the controller, edit the parameters and update the firmware. The USB/RS485 converter is required.



Fig. 1.p

Remote control (IRTRMPX000)

The remote control is used for programming and commissioning the MPXPRO. See the chapter on User interface.



Fig. 1.q

2. INSTALLATION

2.1 MPXPRO: DIN rail assembly and dimensions

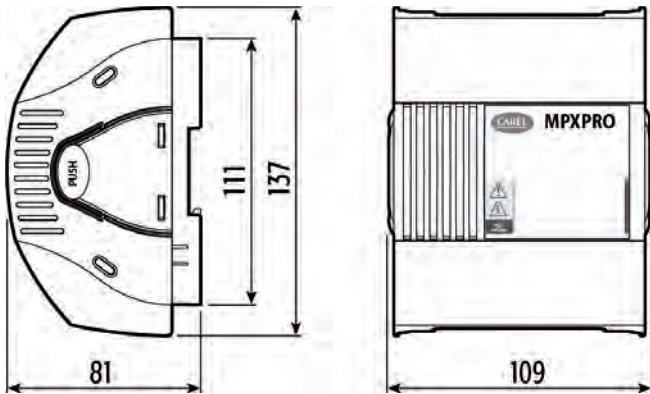

Fig. 2.a

Accessing the terminal block

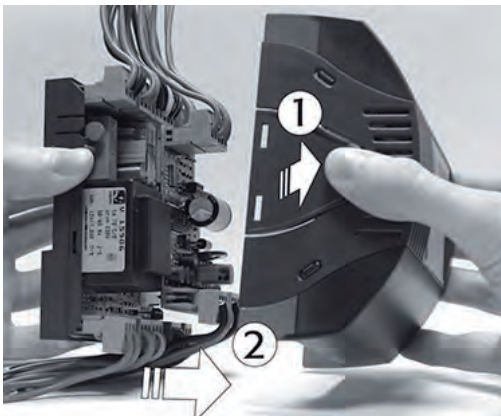

Fig. 2.b

- To remove the cover:
1. press the sides;
 2. remove the cover.

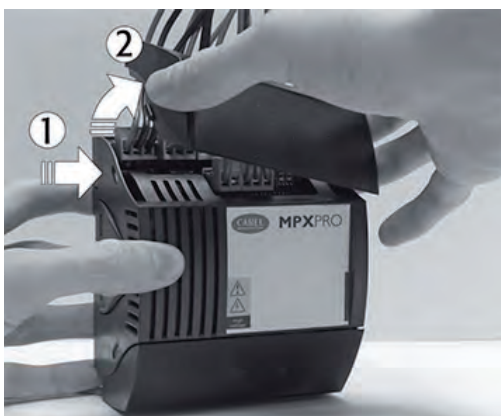

Fig. 2.c

- To remove the covers:
1. press the sides of the cover at the points of coupling;
 2. remove the cover.

MPXPRO optional connections

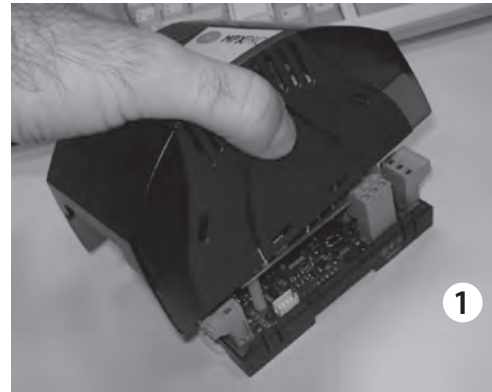

Fig. 2.d

1. Press the cover to remove it;



Fig. 2.e

2. Plug the MXOPZKEYA0/IROPZKEYA0 key into the connector provided.

Note: for models with firmware version ≤ 1.2 only use the IROPZKEYA0 key.

2.2 Main board: description of the terminals

Below is the wiring diagram for the MPXPRO main board in the version with 5 relays. The connectors are screen printed to simplify the electrical connections.

 Note: before performing any operations on the control board, disconnect the main power supply by turning the main switch in the electrical panel OFF.

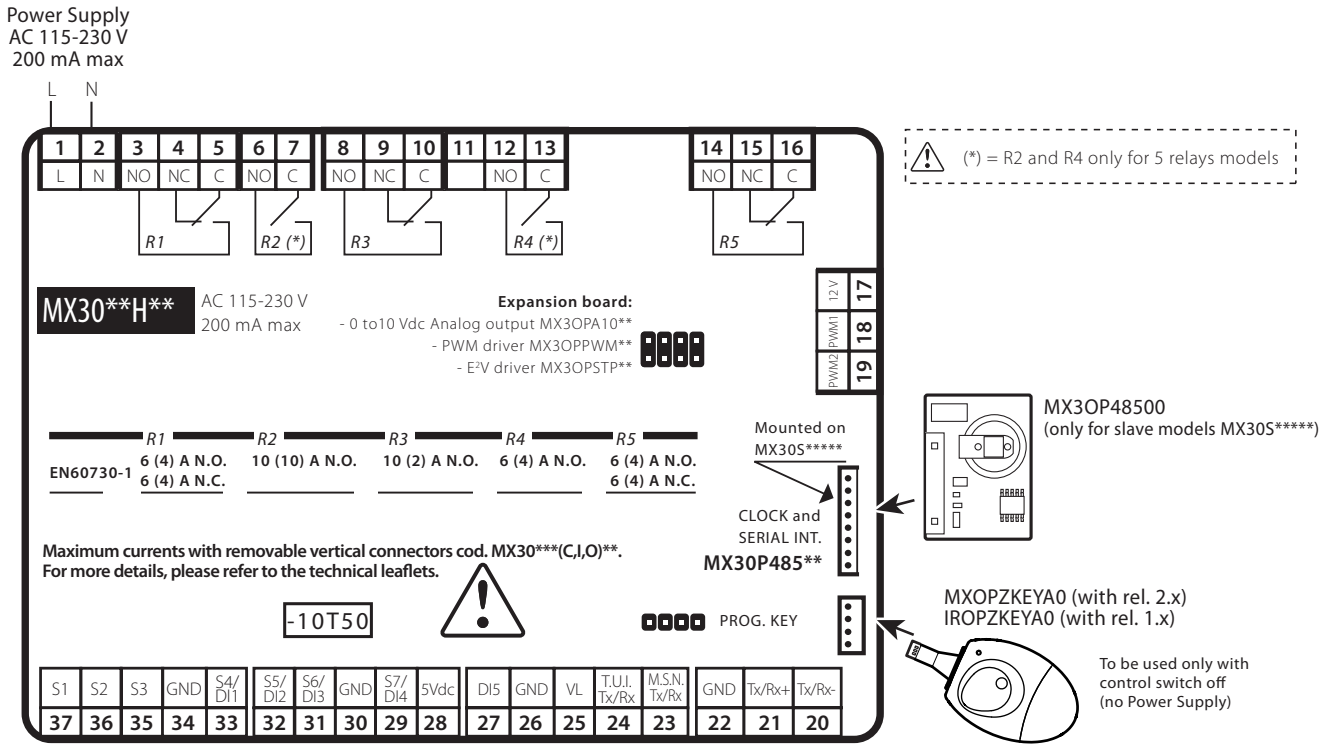



Fig. 2.a

Terminal	Description
1	L Power supply:
2	N 230 Vac, 50mA max. (mod. MX30***E**) 115 Vac, 100mA max. (mod. MX30***A**)
3	NO Relay 1: EN60730-1: 6(4)A N.O.,6(4)A N.C. 2(2)A C.O.
4	NC UL: 6A res 240Vac N.O. / N.C.
5	C 1/2Hp 240Vac N.O. 1/6 Hp 120Vac N.O.
6	NO Relay 2: EN60730-1: 10(10)A N.O. only models
7	C UL: 10A res 1Hp 240/120 Vac N.O. with 5 relays
8	NO Relay 3: EN60730-1: 10(2)A N.O.
9	NC UL: 10A res 240Vac
10	C
11	Not used
12	NO Relay 4: EN60730-1: 6(4)A N.O. only models
13	C UL: 6A res 240Vac; 1/2Hp 240Vac with 5 relays 1/6Hp 120Vac
14	NO Relay 5: EN60730-1: 6(4)A N.O., 6(4)A N.C.
15	NC UL: 6A res 240Vac N.O. / N.C.
16	C 1/2Hp 240Vac N.O.; 1/6Hp 120Vac N.O.
17	+12V Power supply
18	PWM1 Open collector output PWM1: 12Vdc, 20mA MAX
19	PWM2 Open collector output PWM2: 12Vdc, 20mA MAX
20	Tx/Rx- Connection to RS485 network supervisory - CAREL
21	Tx/Rx+ and Modbus® protocol - for Master controller only
22	GND (use shielded cable)
23	M.S.N Tx/Rx Connection to Master/Slave tLAN (Master Slave
26	GND Network). Use shielded cable.
24	Tx/Rx tLAN connection for user terminals and remote
25	VL display
26	GND
26	GND
27	DI5 Multifunction digital input
28	DC 5 V Multifunction analogue/digital input
29	S7/DI4 • NTC, PTC, PT1000, NTCL243 probe
30	GND • 0 to 5 Vdc ratiometric probe • 0 to 10 Vdc analogue input • 4 to 20 mA analogue input • Multifunction digital input
28	DC 5 V Multifunction analogue/digital input
30	GND • NTC, PTC, PT1000, NTCL243 probe
31	S6/DI3 • 0 to 5 Vdc ratiometric probe • Multifunction digital input

Terminal	Description
30	GND Multifunction analogue/digital input
32	S5/DI2 • NTC, PTC, PT1000, NTCL243 probe
33	S4/DI1 • Multifunction digital input
34	GND
35	S3
36	S2
37	S1 NTC/PTC/PT1000/NTCL243 probes

 Note:

- Depending on the model, the main board may have two open collector/PWM analogue outputs for connecting:
 - PWM1: phase-cutting controllers (e.g. MCHRTF****) for inductive loads (e.g. evaporator fans with inductive motors for optically-isolated control);
 - PWM2: SSR relay for the anti-sweat heaters on the display cases;
- The devices with 4 to 20 mA or 0 to 10 Vdc output connected to input S7 cannot be powered directly from the MPXPRO. They therefore require an appropriate external power supply.

 Important:

- The type of input connected to each probe in the same group can be configured by just one parameter. For each group 1(S1,S2,S3)-2(S4,S5)-3(S6)-4(S7), there is just one parameter that defines the type of input, and consequently this must be the same for all the probes in the same group. For group 2, S4 and S5 can be configured as probes yet operate as digital inputs.
- All the contacts should be galvanically insulated by adding further relays for each contact. The digital inputs must not be connected in parallel, otherwise the board may be damaged.

2.3 E²V driver expansion board (MX3OPSTP**): terminals and connections

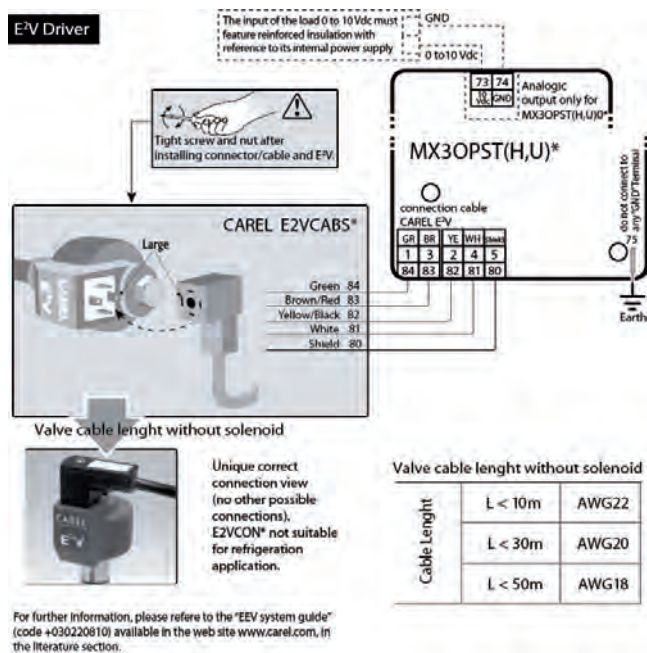

Fig. 2.f

Terminal	Description
73	0 to 10 Vdc output, 4.5 mA MAX
74	GND
75	Functional earth
80	Shield
81	White
82	Yellow/black
83	Brown/red
84	Green

Tab. 2.d

Important:

- To connect the valve, use a CAREL shielded cable code E2VCABS*00 (AWG22) or an alternative suitably sized 4-wire shielded cable:
 - reverse valve or valve size >= E3V45 -> solenoid required with AWG22 shielded cable
 - direct valve and valve size < E3V45 -> if the solenoid is installed AWG22 shielded cable, if the solenoid is not installed, for the size of the cables see the table to the side.
- the input of the 0 to 10 Vdc modulating actuator load must have reinforced insulation, based on its internal power supply.

2.4 PWM driver expansion board (MX2OPPWM**): terminals and connections

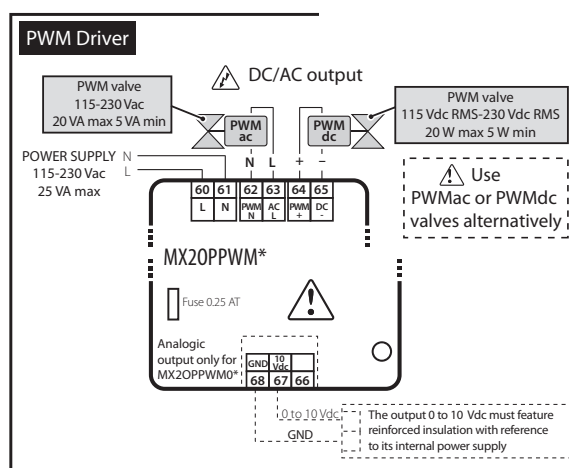

Fig. 2.g

Terminal	Description
60	L
61	N
62	N
63	L
64	+
65	-
66	Not used
67	0 to 10Vdc output
68	GND

Tab. 2.e



Note:

- use either AC or DC PWM valves;
- the input of the 0 to 10 Vdc modulating actuator load must have reinforced insulation, based on its internal power supply.



Important: do not use PWM valves with rectified 230 Vac power supply.

2.5 Expansion board 0 to 10 Vdc output (MX*OPA10**): terminals and connections

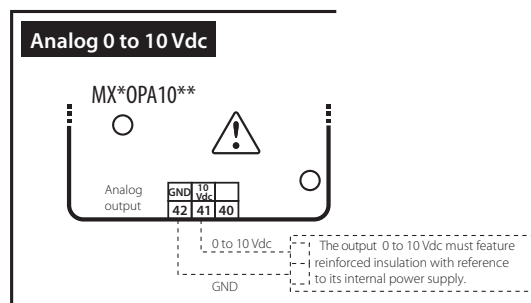

Fig. 2.h

Terminal	Description
40	Not used
41	0 to 10Vdc output
42	GND

Tab. 2.f



Note: the input of the 0 to 10 Vdc modulating actuator load must have reinforced insulation, based on its internal power supply.

2.6 Functional diagrams

The MPXPRO controllers are systems that manage refrigeration units (for example, one or a series of multiplexed showcases). These systems are made up of control boards connected together in Master-Slave mode; each Master board can manage up to 5 Slaves. The functional diagrams below show some examples of typical applications:

1. Stand alone configuration and optional cards available

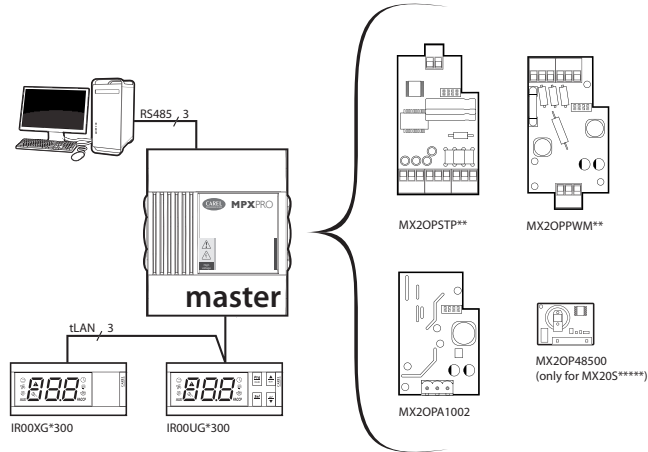

Fig. 2.i

For the electrical connections see the general connection diagram in par. 2.8.

The Master controller can be supplied without the driver board (MX30M00E00), with the driver board for E2V valve (MX30*25E00) or with PWM driver board (MX30*24E00).

Available options:

- 0 to 10 Vdc expansion board (MX*OPA10**). If installed, the drivers cannot be fitted: in this case the driver board with the 0 to 10 Vdc output incorporated;
- on MPXPRO Slave boards (MX30S****) the RTC and RS485 serial interface accessory (MX30P48500) can be added

2. Master/ Slave network with user terminals and remote display

The Master controller, connected to the supervisor network, acts as the gateway and coordinates the functions of the 5 Slave controllers connected in the tLAN. Each controller has its own user terminal and remote display.

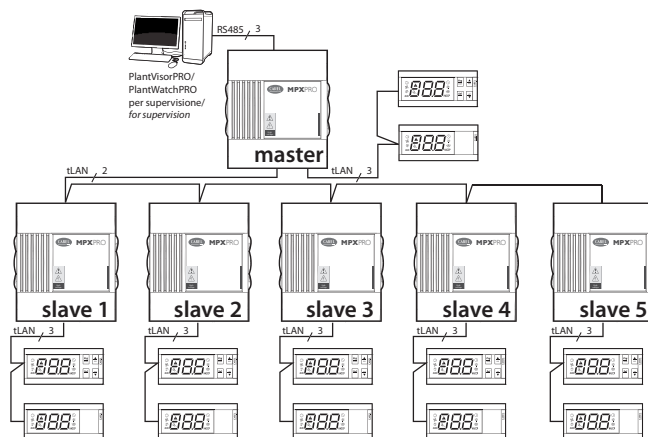

Fig. 2.j

For the electrical connections see the general connection diagram in par. 2.8.

3. Master/Slave network with shared user terminal and local remote display.

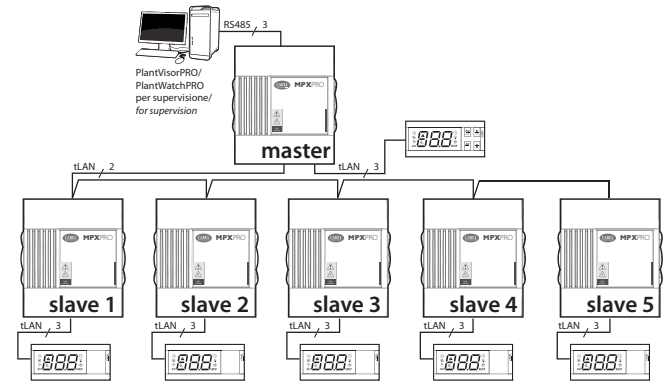

Fig. 2.k

For the electrical connections see the general connection diagram in par. 2.8.

4. RS485 supervisor network

The maximum number of Master controllers that can be connected in the network also depends on the number of Slaves connected to each Master; the maximum total is 199 controllers (CAREL and Modbus® protocol).



Fig. 2.l

For the electrical connections see the general connection diagram in par. 2.8.

2.7 Connecting the MCHRTF**** module

The connection of the MCHRTF**** single-phase speed controller for evaporator fans requires a resistor in series, as shown in the following figure:

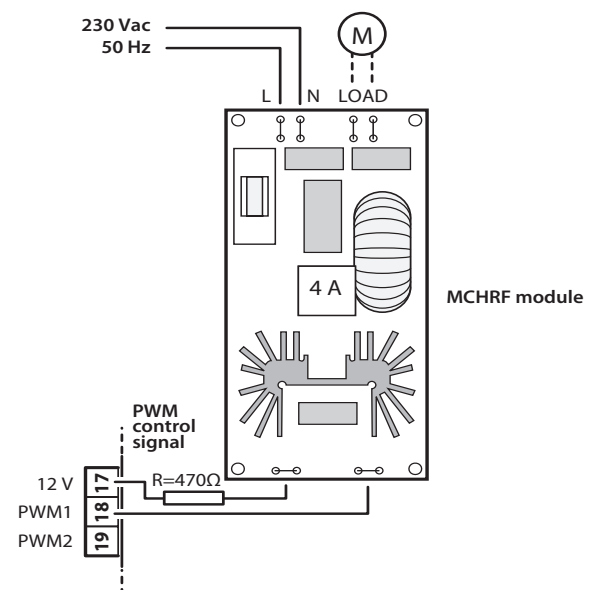

Fig. 2.m

2.8 General connection diagram

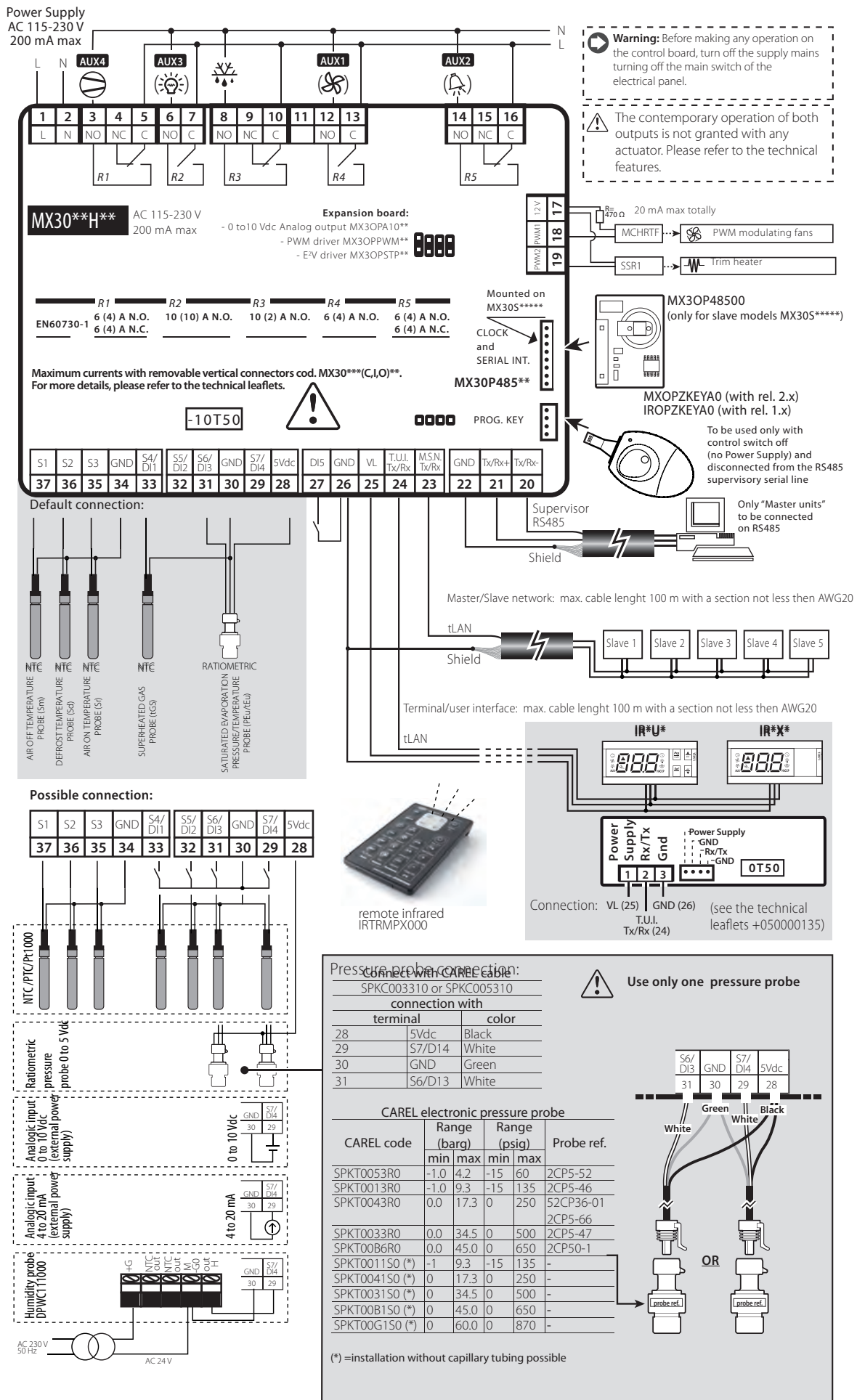

Fig. 2.n

2.9 Installation

For installation proceed as follows, with reference to the wiring diagrams:

- before performing any operations on the control board, disconnect the main power supply by turning the main switch in the electrical panel OFF. Then remove the plastic side cover and/or the covers to make the electrical connections;
- avoid touching the control board, as electrostatic discharges may damage the electronic components;
- the index of protection required for the application must be ensured by the manufacturer of the display case or by suitable assembly of the controller;
- connect any digital inputs, $L_{max}=10m$;
- connect the power cable to the valve motor: to find the section or cable length, see "terminals and connections" section.
- connect the actuators: the actuators should only be connected after having programmed the controller. Carefully evaluate the maximum ratings of the relay outputs as indicated in "Technical specifications";
- program the controller: see the chapter "User interface".
- for the tLAN connection of the Master/Slave network and user interfaces, use shielded cable and make sure:
 - the maximum distance between a controller and its user terminal/remote display is 100 m (with section of cable not less than AWG22);
 - the maximum distance between the controllers and the maximum length of the cable between one controller and another is 100 m (with section of cable not less than AWG22).

! Important: avoid installing the controllers in environments with the following characteristics:

- relative humidity greater than the 90% or condensing;
- strong vibrations or knocks;
- exposure to continuous water sprays;
- exposure to aggressive and polluting atmospheres (e.g.: sulphur and ammonia fumes, saline mist, smoke) to avoid corrosion and/or oxidation;
- strong magnetic and/or radio frequency interference (avoid installing the controllers near transmitting antennae);
- exposure of the controllers to direct sunlight and to the elements in general.

! Important: when connecting the controllers, the following warnings must be observed:

- incorrect connection to the power supply may seriously damage the controller;
- use cable ends suitable for the corresponding terminals. Loosen each screw and insert the cable ends, then tighten the screws and lightly tug the cables to check correct tightness;
- separate as much as possible the probe and digital input cables from the power cables to the loads so as to avoid possible electromagnetic disturbance. Never lay power cables and probe cables in the same conduits (including those in the electrical panels);
- avoid installing the probe cables in the immediate vicinity of power devices (contactors, circuit breakers, etc.). Reduce the path of the probe cables as much as possible and avoid enclosing power devices.

➡ Note: when connecting the RS485 serial network:

- connect the shield to the GND terminals on all controllers;
- do not connect the shield to the earth on the electrical panel;
- use a twisted pair shielded cable (e.g. Belden 8762 – AWG 20 or BELDEN 8761-AWG 22);
- connect a 120 Ω terminal resistor between the Tx/Rx+ and Tx/Rx- terminals on the last MPXPRO controller.

2.10 Programming key (copy set-up)

! Important: the key must be used with the controller off and with the RS485 serial line disconnected from the MPXPRO. The MXOPZKEYA0/IROPZKEYA0 programming key is used to copy the complete set of MPXPRO parameters. The key must be plugged into the connector (4 pin AMP) on the controllers (with the controller powered down).

➡ Note: MXOPZKEYA0 can only be used on MPXPRO with firmware versions ≥ 2.1 (with max. 6 sets of parameters); IROPZKEYA0 can only be used on MPXPRO with firmware versions ≤ 1.2 (with max. 2 sets of parameters).

The firmware version of the MPXPRO can be identified as follows:

- on the label applied to the rear of the instrument. The second part of the revision number represents the firmware version (e.g. Rev. 1.326 means firmware revision 2.6). This info is valid only if the MPXPRO has never been updated by the user;
- on the terminal display. When powering up the MPXPRO, the terminal displays the firmware revision (e.g. r 2.6) for a couple of seconds;
- using the VPM or from the supervisor (Integer variable 11: Firmware release). Official versions available are 1.0, 1.1, 1.2 - 2.1, 2.2, 2.6, 2.8.

By setting the two dipswitches (accessible when removing the cover), the programming key can run the following functions:

- UPLOAD. Load the parameters from a controller to the key (see Fig. 2.p): the key acquires all the parameters available on the controller;
- DOWNLOAD. Copy from the key to a controller (see Fig.2.q): the key only transfers the operating parameters to the connected controller;
- EXTENDED DOWNLOAD. Extended copy from the key to a controller (see Fig.2.r): the key transfers all the parameters (operating and unit) to the connected controller.

! Important: the copy and extended copy of parameters can only be performed between compatible instruments, that is, with the same or higher firmware revision (e.g. copy from 2.2 to 2.4, but not vice-versa). Version 4.0 will only be compatible with version 3.3, so a configuration corresponding to version 3.3 (and not lower) can be loaded onto an MPXPRO version 4.0. If copying between different hardware, it is recommended to check the parameters corresponding to the specific configuration (e.g.: valve parameters).

The UPLOAD, DOWNLOAD and EXTENDED DOWNLOAD functions are performed as follows:

- open the rear cover of the key and set the two dipswitches based on the desired operation;
- close the cover, power up the key and plug the key into the connector on the controller;
- press and hold the button until the red LED flashed briefly, after around 5-10 s (the button can still be held). When the button is released, the LED stays on red until the end of the operation, which may last up to a maximum of 45 sec. The operation is completed successfully when the green LED comes on. With the button released, the green LED goes off after around 2 seconds. Other signals or flashing of the LEDs indicate that problems have occurred: see the corresponding table;
- remove the key from the controller.

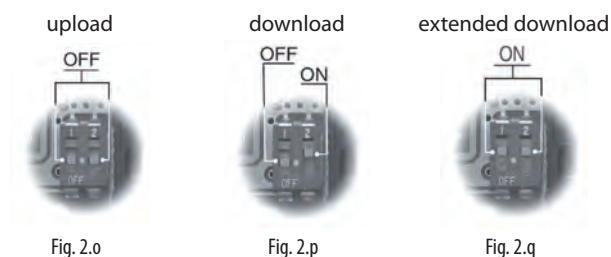

LED signal	Cause	Meaning	Solution
Orange flashing	Controller not compatible	The parameters cannot be copied due to incompatibility of the firmware versions	Check compatibility of the firmware versions (see notes above)
Red flashing	Incorrect use of the key	The button on the key has been released too early	Repeat the procedure following the instructions in point c.
Orange steady	Data copy error	The data on the controller or the key may be corrupt	Repeat the operation or contact service
Off	Key not powered or fault	--	Check that the key is powered or contact service

Tab. 2.g

The key can be programmed not only from the MPXPRO controller, but also directly from a PC, using the special USB/I2C converter (IRPOPZPRG00) and the VPM program. Using this connection, the PC can completely program the key. Specifically, the following operations are possible: set the values of the parameters (both unit and operating), set the visibility and upload attribute, write and read the parameters to/from a file, and check the parameters.

2.11 Commissioning tool (VPM- Visual Parameter Manager)

MPXPRO can communicate directly with a PC using the “commissioning” port. This connection can be used to program and check the operation of an MPXPRO controller from the PC when installing and first starting the system. The commissioning connection can be used to:

- set value, visibility and download attributes of all the parameters from Master to Slave, including unit parameters;
- completely program a key;
- at start-up, monitor and manually control all the inputs/outputs;
- update the firmware.

A PC can access the commissioning connection via the special port available on some user terminals code IR00UGC300 and remote display code IR00XGC300 or in supervisory RS485 network. The commissioning software can also be used to program the key. Further information on the operation of the commissioning software is available in the online manual for the VPM program, downloadable from <http://ksa.carel.com>.

Commissioning via the RS485 supervisor port (with CVSTDUMOR0 converter)

As well as the connection via the terminal, MPXPRO can also be connected to a PC via the RS485 supervisory network. In this case, the PC will only be connected to the Master controller. Access to the parameters (unit and operating) and status variables relating to the Slaves connected to the Master will be available via the Master controller.

To use this commissioning connection:

- connect a Master controller (board terminals 20, 21, 22) to the RS485 output on the CVSTDUMOR0 converter, using an RS485 connection cable;
- connect the USB ports on the converter and the PC using a USB cable.

Note: To manage the Slave controllers in the subnetwork from the PC, make sure that these are correctly connected to the Master via the tLAN.

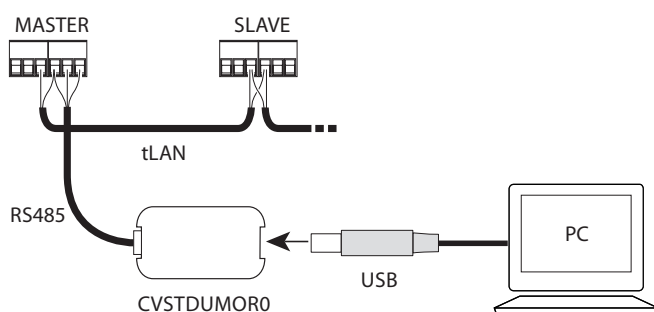

Fig. 2.r

2.12 Setting the default parameters/loading the parameter sets

Introduction

Seven different sets of parameters are saved in the MPXPRO memory. Set 0, called the working set, contains the set of parameters used by MPXPRO during normal operation. This set is loaded whenever MPXPRO is started, and the parameters can be modified at any time from the terminal, supervisor, remote control, VPM and programming key.

The other six sets of parameters, numbered 1 to 6, contain other lists of parameters, preloaded by CAREL during production, which can be copied as desired to the working set (Set 0). These sets of parameters, unlike Set 0, can only be modified using the programming key and the VPM. The sets of parameters, once differentiated by the manufacturer of the unit, can be loaded so as to rapidly set a list of parameters, with corresponding values, to control the refrigeration system.

Parameter sets from 1 to 6 can be modified as follows:

1. copy the parameters from MPXPRO to the programming key (MXOPZKEYA0 (UPLOAD));
2. read the parameters saved on the programming key using VPM;
3. select the set and modify the parameters using VPM. For each parameter, the value, visibility, enabling to copy from Master to Slave, and configurability at first start-up can all be set;
4. write the parameters to the programming key using VPM;
5. copy the parameters from the programming key to MPXPRO (DOWNLOAD). See paragraph 2.10.



Note:

- when copying the parameters from the key to MPXPRO and vice-versa, MPXPRO must not be powered;
- to read/write the parameters on the key using VPM, the converter code IR0PZPRG00 is required.



Important: modifying the set of parameters saved in the MPXPRO memory using the key permanently overwrites the parameters set by CAREL. The set of default parameters is never overwritten, being stored in a non-modifiable area of memory.

Procedure for setting the default parameters / loading the parameter sets

Procedure:

1. power down the controller;
2. press the Prg/mute button;
3. power up the controller again while holding Prg/mute: at the end, the number 0 is displayed, which represents set 0;
4. to load the default parameters, press the SET button to confirm set 0, otherwise see step 5;
5. press UP/DOWN to choose the set of parameters (from 1 to 6) to be loaded as the working set, and confirm by pressing SET;
6. at the end of the procedure, the display will show the message “Std.”, indicating that the procedure has ended;
7. if required, run the guided commissioning procedure (see par. 4.3)



Note: the procedure loads a set of parameters as desired, from 1 to 6. The maximum number of parameter sets that can be loaded is limited by the value of parameter Hdn, not visible on the keypad and only modifiable using VPM or the programming key. For example, if Hdn=3, during the procedure only parameter sets from 1 to 3 can be loaded on the controller.

Par.	Description	Def.	Min	Max	U.O.M.
Hdn	Number of default parameter sets available	0	0	6	-

Tab. 2.h

3. USER INTERFACE

The front panel of the user terminal (IR00UG****) includes the display and the keypad, featuring 4 buttons that, pressed alone or in combination, are used to program the controller. The remote display (IR00XG****) is only used to show the values of system variables.

3.1 User terminal and remote display

The display shows measurements in the range -50 and +150 °C, according to the type of probe used. The measurement is displayed with resolution to one tenth between -19.9 and + 19.9 °C. For 0 to 5 V ratiometric and active 0 to 10V or 4 to 20 mA probes the unit of measure is defined by the type of probe used. The decimal point can be disabled by setting a par. (/6).

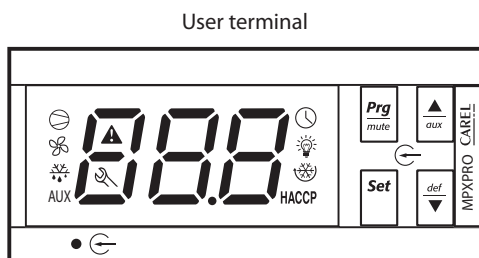

Fig. 3.a

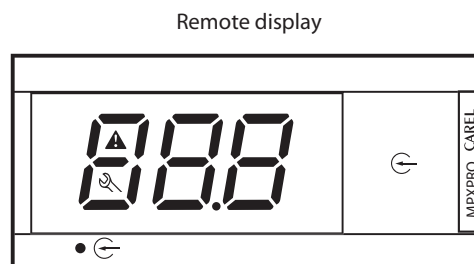

Fig. 3.b

Icon	Function	Icon / function status			Note
		Active	Not active	Request	
	Compressor/Solenoid	Active	Not active	Request	Flashes when activation is delayed or stopped by protection times.
	Evaporator fans	Active	Not active	Request	Flashes when activation is prevented due to external disabling or procedures in progress.
	Defrost	Active	Not active	Request	Flashes when activation is prevented due to external disabling or procedures in progress.
AUX	Auxiliary output	Active	Not active	-	Comes on with activation of the auxiliary output selected as local or network auxiliary.
	Alarm	Pre-activation of the delayed external digital alarm	-	Alarm in progress	Flashes in the event of alarms during normal operation (e.g. high/low temperature) or alarms from external digital input, immediate or delayed, on both Master and Slave controllers.
	Clock	Night-time operation	-	Clock alarm	On power-up the icon indicates the Real Time Clock (RTC) is fitted.
	Light (local or network)	Active	Not active	-	
	Service	On the Master indicates Upload parameters to Slaves	-	System error in progress	During commissioning, indicates that the parameter has not been set; during the connection to the remote control indicates override in progress.
HACCP	HACCP	HACCP function enabled	-	HACCP alarm saved	During the HACCP alarm HA and/or HF is shown on the display.
	Continuous cycle	Continuous cycle function activated	-	Request	Flashes when activation is prevented due to external disabling or procedures in progress (e.g. minimum compressor OFF time)

Tab. 3.a



Note:

- with the alarm, clock, service and HACCP icons active, flashing has priority over ON. For example, in night-time operation (clock icon on), the icon will flash if there is a clock alarm;
- the value to be displayed on the user terminal can be configured by setting parameter /t1, and on the remote display by setting parameter /t2.

3.2 Keypad

Setting	Function	Front keypad controls	Display when setting / notes	
			Duration	Notes
Set point	Temperature set point			Value on display flashing
				Set value
				Save set point and return to standard display
Access the parameters (programming level)	Type F parameters (frequ.)		5 s	The first type F parameter is displayed
	Type C (configuration) or A (advanced) parameters		5 s	Enter password (22 for configuration level and 33 for advanced level)
				Confirm the password, the first type C or A parameter is displayed
Output from the livello programming			5 s	The changes are saved

Setting	Function	Front keypad controls	Display when setting / notes	
			Duration	
Defrost	Local defrost		5 s	dFb : activate defrost dFE : deactivate defrost
	Multiplexed defrost (Master only)		5 s	dFb : activate defrost dFE : deactivate defrost
Auxiliary functions	Continuous cycle		5 s	ccb : activate continuous cycle (see paragraph 6.6) cCE : deactivate continuous cycle
	AUX output			Activate/deactivate auxiliary output
Network functions (only for Master)	Copy parameters from Master to Slave		5 s	
				Enter password (default 66)
				See paragraph 3.6: "Copy parameters from Master to Slave"
Set the default parameters (restore parameters)	Set default parameters (*)			on power-up
				If 0 is displayed press set to continue
Alarms	Display alarm log		5 s	
				Enter password (default 44)
				See paragraph 9.3: "Display alarm log"
	Manual alarm reset		5 s	"rES" indicates the alarm has been reset
	Mute buzzer and disable alarm relay			
HACCP	HACCP menu			See par. 9.4 "HACCP alarms and display"

Tab. 3.b

(*) The default parameters, or any of the sets of parameters loaded inside MPXPRO, only have effect on the parameters visible from the user terminal, based on the list of parameters. The parameters that are not visible on the user terminal are not affected by this procedure.

3.3 Programming

The parameters can be modified using the front keypad. Access differs according to the type: Frequent (F), configuration (C) and advanced (A) parameters. The type of parameter is indicated in the table parameters. Access to the configuration and advanced parameters is protected by a password that prevents unwanted modifications by unauthorised people. The password for the advanced parameters also allows access to all the control parameters; this operation must only be performed by qualified personnel.

Select network unit (Master)

If using a user terminal connected directly to the Master controller, this function can be used to choose the desired unit. After having identified the required setting (e.g. edit parameters, access the alarm log,...), then:

- scroll the list of Slave units available pressing UP or DOWN;
- press Set to select the desired unit:

uM	u1	u2	u3	u4	u5
Master	Slave 1	Slave 2	Slave 3	Slave 4	Slave 5

Tab. 3.c

(OUx indicates that controller x is OFFLINE);

- to return to the normal display press Prg/mute.

The controller will in any case return to the normal display after a timeout of around 1 minute.



Fig. 3.c

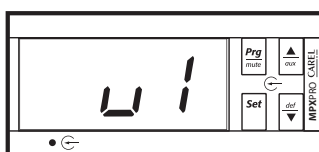

Fig. 3.d

Note: this specific procedure can be managed from the Master controller only, if the user terminal is connected to a Slave controller the procedure is limited to that Slave only.

Changing the set point (St)

To modify the set point (default =50°C):

Procedure:

- press Set until the display shows the current value of St, flashing;
- press UP or DOWN to reach the desired value;
- press Set briefly to confirm the new value of St;
- the standard display will be restored.



Fig. 3.e

Accessing the type F parameters

The type F parameters (frequent) include the probe calibrations, set point and differential, end defrost temperature, maximum defrost duration, alarm thresholds, evaporator fans activation threshold and differential, and superheat set point. See the table of parameters.

Procedure:

1. press Prg/mute for more than 5 seconds (if there are active alarms the buzzer is muted): the display shows the code of the first type F parameter available, /c1;
2. see the paragraph "Setting the parameters", point 1.

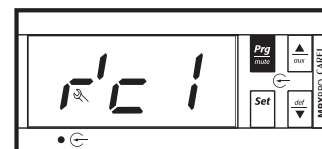

Fig. 3.f

Important: if no button is pressed, after 10 s the display starts flashing, and after 1 minute the standard display will automatically be restored.

Accessing the type C parameters

The type C parameters (configuration) include the choice of variable displayed on the user terminal, assignment of the of the outlet, intake and defrost functions to the probes, configuration of the digital inputs, behaviour of the evaporator fans during defrost, configuration of the Master/Slave network, and defrost time bands. See the table of parameters.

Procedure:

1. press Prg/mute and Set together for more than 5 seconds (if there are active alarms the buzzer is muted): the display shows the number 0 flashing;
2. press UP or DOWN and enter the **PASSWORD:22**. Confirm by selecting Set;
3. the first modifiable type C parameter is displayed, /4;
4. see the paragraph "Setting the parameters", point 1.

Accessing the type A parameters

The type A parameters (advanced) include the choice of the type of probe (NTC, PTC, PT1000, NTC L243) for each of the four groups of probes, assignment of the superheat control, ambient temperature and humidity and glass temperature probes, compressor protection parameters, the parameters that define the defrost algorithm used (Sequential stops, Running time, Power defrost, Skip defrost, etc.), maximum and minimum evaporator fan speed, the integration times and delays for the superheat protection functions, and the parameters for displaying the normal and HACCP alarm queue.

1. press Prg/mute and Set together for more than 5 seconds (if there are active alarms the buzzer is muted): the display shows the number 0 flashing;
2. press UP or DOWN and enter the **PASSWORD:33**. Confirm by selecting Set;
3. the first modifiable type A parameter is displayed, /2;
4. see the paragraph "Setting the parameters", point 1.



Important:

- with this procedure, available starting from firmware version 2.x, all the controller parameters can be accessed;
- the type of parameters (F= frequent, C= configuration, A= advanced,) and the related password can be modified using the VPM program.

Setting the parameters

Once having accessed the desired level of parameters (F, C or A):

1. press UP or DOWN until reaching the desired parameter: when scrolling, an icon appears on the display representing the category the parameter belongs to (see the table below and the table of parameters);
2. or: press Prg/mute to display the menu of parameter categories. See the table of parameters at the end of manual for further details on the categories. Press UP/DOWN until reaching the desired category of parameters and press Set: the list of parameters in the selected category is displayed;

Category	Icon	Category	Icon
Probes		Electronic valve	
Control		Configuration	AUX
Compressor		Alarm log	
Defrost		HACCP	HACCP
Alarm		RTC	
Evaporator fans			

Tab. 3.d

3. press UP or DOWN until reaching the desired parameter;
4. press Set to display the associated value;
5. increase or decrease the value of the parameter using UP or DOWN;
6. press Set to **temporarily** save the new value and return to display the parameter code;
7. if the parameter has sub-parameters, after having selected the parameter, press Set again to enter the sub-menu, use the UP or DOWN button to scroll between the sub-parameters, which can be modified like a normal parameter. Press Set again to temporarily save the values and Prg/mute return to the higher level menu;
8. repeat steps from 3) to 7) to modify other parameters;
9. to **permanently** save the new values assigned to the parameters Prg/mute for 5 seconds. This exits the parameter setting procedure.



Note:

- all the changes made to the parameters, temporarily stored in the RAM, can be cancelled, returning to the standard display by not pressing any button for 60 seconds. The values of the clock parameters, however, are saved when entered.
- if the controller is powered down before pressing Prg/mute, all the changes made to the parameters will be lost
- in the two parameter setting procedures (C and A), the new values are only saved after having pressed Prg/mute for 5 seconds. When setting the set point, the new value is saved after confirming with Set.

3.4 Ex.: setting current date/time and day/night time bands

Setting the current date/time

1. press Prg/mute for 5 seconds: this accesses the list of type F parameters;
2. press Prg/mute: the first category of parameters, "Pro", is shown;
3. press the UP/DOWN buttons until reaching category "rtc", highlighted by the "clock" icon at the top right;
4. press Set: parameter "tc" is displayed. Press Set: parameter y is displayed followed by two digits that indicate the current year;
5. press Set and set the value of the current year (e.g.: 8=2008), press Set again to confirm;
6. press the UP button to select the next parameter, M=month, and repeat steps 3, 4 and 5 for parameters: M=month, d=day of the month, u=day of the week, h=hour, m=minutes;
7. to return to the list of main parameters press Prg/mute.

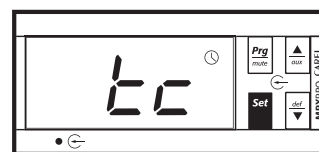

Fig. 3.g

Par.	Description	Def.	Min	Max	U.O.M.
tc	Date/time (Press Set)	-	-	-	-
y	Date/time: year	0	0	99	year
M	Date/time: month	1	1	12	month
d	Date/time: day of the month	1	1	31	day
u	Date/time: day of the week	6	1	7	day
h	Date/time: hours	0	0	23	hour
n	Date/time: minutes	0	0	59	min

Setting the day/night time bands

Procedure:

1. access the type C parameters as described in the corresponding paragraph and select the RTC category;
2. press UP/DOWN and select the parent parameter tS1 = time for switching from night to day;
3. press Set: the parameter d followed is displayed by one or two digits that indicate the day for switching from night to day mode, as follows:
 - 0 = switching disabled;
 - 1 to 7 = Monday to Sunday;
 - 8 = Monday to Friday;
 - 9 = Monday to Saturday;
 - 10 = Saturday & Sunday;
 - 11 = every day.
4. press Set to confirm and go to the next parameters: h=hour, m=minutes
5. press Set to confirm and Prg/mute to go to parameter tE1 = time for switching from day to night.

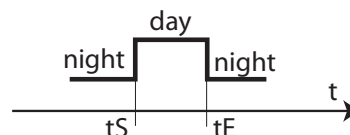

Fig. 3.h



Note: 8 time bands can be set for each day, setting parameters tS1 to tS8 and tE1 to tE8.

3.5 Copy parameters from Master to Slave (Upload)

All the parameters with upload attribute can be uploaded from a Master controller to the Slave controllers in the subnetwork. The upload attribute can only be set for the parameters using the VPM program (Visual Parameter Manager). This procedure can be used instead of the programming key, with the advantage of being able to update all the Slave boards in the subnetwork at the same time, without powering down the controllers and without overwriting the parameters that should not be modified, such as the serial address, the clock parameters, etc. rather than having to repeat the procedure individually for each board with the programming key.

Procedure:

1. press Prg/mute and Set together for more than 5 seconds (if there are active alarms the buzzer is muted): the display shows the number 0 flashing;
2. press UP or DOWN and enter the **PASSWORD:66**. Confirm by selecting Set;
3. press UP or DOWN to select the Slave controller to be programmed. Confirm by selecting Set. Selecting ALL programs all the Slave controllers in the network;
4. during the programming procedure, the terminal display shows the normal display alternating with the message uPL, and the spanner icon comes on;
5. once the programming procedure is complete, the message uPL disappears and the spanner icon goes off. In the event of errors, the message uPX is displayed (X= number of the Slave controller where the error occurred).



Fig. 3.i

3.6 Using the remote control (accessory)

The MPXPRO remote control is an instrument developed to simplify the programming and setup of an MPXPRO controller. As well as the traditional remote keypad, it features a series of functions used to override the status of the outputs and inputs, so as to completely test the connections and the operation of the application.

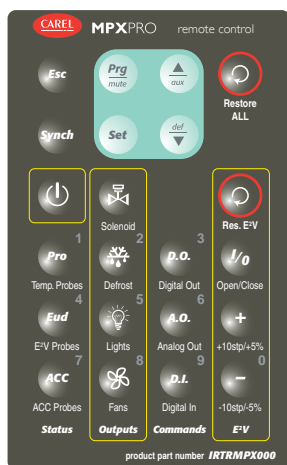

Fig. 3.j

Description

The MPXPRO remote control features a series of buttons, divided into groups based on their function. In addition to the traditional remote keypad, it has a special section for displaying the overall status of the controller (probes, internal variables), manually overriding the inputs and outputs, and manually positioning the electronic expansion valve (EEV). The MPXPRO remote control interacts with all terminals/displays fitted with infrared receiver (IR00UGC300, IR00XGC300).

The parameter relating to the enabling code is H3:

Par.	Description	Def	Min	Max	UoM
H3	Remote control enabling code 00 = programming from remote control without code	0	0	255	-

Tab. 3.e

Remote control during start-up

When started for the first time, MPXPRO displays the start-up procedure. In this phase, the remote control is always active on all controllers, without distinction between codes, and consequently the parameters can be set without having to activate the remote control or enter specific codes. As a result, operate near the display is question, in order to avoid interfering with other controllers.

Activating the remote control



Synch: enable the use of the remote control; Esc: disable the use of the remote control.

After pressing Synch, each device displays its value of parameter "H3: remote control enable code", if not null. The numeric keypad can be used to specify the code of the instrument in question, so as to avoid interference with the other devices..



Important:

- parameter H3 is equal to 0 by default on all MPXPRO controllers, to avoid interference within the operating range of the remote control; the values of parameter H3 should be unique for each device.
- after 5 minutes without pressing any button, the remote control connection is automatically interrupted, together with any active overrides. To keep the connection and any overrides active, press any button before the 5 minutes elapse. Before interrupting the connection, the display flashes for 10 seconds to signal the imminent disconnection.
- the remote control can be disabled completely by setting parameter H2=3.

Remote keypad and navigation

button	Pressed briefly (1 s)	Pressed and held (5 s)
	Return to the previous menu Mute buzzer	Return to the initial display and save changes Access ALL the parameters
	Edit parameter Confirm changes	Display set point
	Scroll	Light /Aux
	Scroll	Defrost ON/OFF

ON/OFF



Used to switch the instrument to the OFF logical status; in this status all the control functions are deactivated, except for communication with the supervisor, the Master/Slave network and management of probe alarms.

Status area: display instrument status



Used for direct and immediate access to the values read by the probes on the MPXPRO and the main internal variables used for the various control functions. The three buttons access three different menus. The menus are navigated in the same way as on a traditional user terminal:

- to enter/exit the menu for the displaying the temperature probes;
- to enter/exit the menu for the displaying the probes/status relating the electronic expansion valve;
- to enter/exit the menu for the displaying the probes/status relating to the anti-sweat function.

Below is a list of all the variables (with corresponding code) displayed in the various menus:

Pro		Eud		Acc	
SM	Outlet probe temp.	SH	Superheat	dPt	Dewpoint
Sd1	Defrost probe temp.	P3	Superheat set point	SA	Ambient temp.
Sr	Intake probe temp.	PPU	Position (%) EEV	SU	Ambient humidity
Su	Virtual probe temp.	PF	Position (steps) EEV	SUt	Glass probe temp.
SrG	Control probe temp.	tEu	Saturated evaporation temperature	rAP	Anti-sweat heater PWM output
St	Set point	tGS	Superheated gas temperature	rA	Anti-sweat heater output %
StU	Working set point	PEu	Evaporation pressure		
Sd2	Aux. defrost probe temp.				
SA1	Auxiliary probe 1 temp.				
SA2	Auxiliary probe 2 temp.				

“Outputs” area: directly override the digital outputs

Used to manually override the status of the various digital outputs. Manually overriding an output disables the normal operation of the instrument, that is, the MPXPRO controller does not act on the overridden outputs. The MPXPRO display signals that at least one output has been manually overridden by switching on the spanner icon. The override using the 4 buttons in this section is cyclical, that is, the function changes status cyclically each time the specific button is pressed. The override starts when the button is first pressed. The status of the most common logical functions can be overridden:



Solenoid/compressor Defrost Light Fans

MPXPRO displays the outputs that are active by switching on the corresponding icon. Pressing the “Restore ALL” button briefly (1 sec) deactivates the overrides on the digital outputs in this section. Pressing and holding the “Restore ALL” button disables all the overrides activated from the remote control. Once the overrides have been disabled, the controller automatically resumes normal operation.



Important: overriding the status of the solenoid output may cause the activation of the fan outputs, depending on the configuration of the fan parameters (see configuration parameters F0 and F2).

“Commands” area: override digital-analogue outputs and digital inputs.

This section can be used to override all the outputs on the MPXPRO, both digital and analogue, as well as the digital inputs. The structure is similar to the display of the probe readings, there are 3 submenus directly accessible by pressing the 3 buttons:

p.o.		A.O.		D.I.	
CMP	Solenoid/compressor	PF	Position (steps) EEV	di1	Dig. input 1
dEF	Defrost	PPU	Position (%) EEV	di2	Dig. input 2
FAn	Evaporator fans	FSC	Modulating fans	di3	Dig. input 3
LiG	Light	rA	Anti-sweat heater output %	di4	Dig. input 4
AU	AUX			di5	Dig. input 5
ALM	Alarm				
dF2	Defrost aux				
SSu	Suction valve				
ESu	Equalizing valve				

Navigation inside the menus is the same as on any user terminal. Pressing any of the 3 buttons enters one of the menus, “Up” or “Down” scrolls the variables, pressing “Set” displays the value of the selected variable, and changing the value using “Up” or “Down” overrides the value. When scrolling the menus, the display shows which variable is currently virtualised by switching on the spanner icon. The override of any variable can be disabled individually by briefly pressing (1 sec) the “Restore ALL” button corresponding to the specific variable. From the main menu, pressing and holding (5 sec) the “Restore ALL” button disables all the active overrides.

“E²V” area: override position of the electronic expansion valve

In this section, the position of the electronic expansion valve can be controlled manually. As in the other cases, the override function is activated by pressing the button once. When pressing one of the buttons, the display shows the position reached for 3 seconds, then resumes the display of the previous variable, to allow the position of the valve to be changed and then immediately observe the result. Specifically, the various buttons have the following functions:



- cyclically open/close the expansion valve completely, each command is signalled on the display by the message “OPn”, if the valve is opening, or “CLo” if the valve is closing, for 3 seconds;
- increase the position of the valve. The effect depends on the type of valve configured. For E²V stepper valves, each time the button is pressed the position of the valve increases by 10 steps, while for PWM valves it increases by 5%;
- decrease the position of the valve. As above, for E²V stepper valves the position decreases by 10 steps, while for PWM it decreases by 5%;
- Res E²V: pressed for 5 seconds, restores the normal operation of the electronic valve. This button is used to disable the override on the electronic expansion valve only.

Disabling the overrides

The MPXPRO remote control can disable the overrides in four different ways:

with the “Restore ALL” button

- Pressed briefly (1 sec) from the main menu: disables the overrides of the digital outputs in the “Outputs” section
- Pressed briefly (1 sec) from the “Commands” menu: disables the override on each individual variable
- Pressed and held (5 sec) from the main menu: completely disables all the overrides

with the “Res. E²V” button”

- Pressed and held (5 s): disables the override on the electronic valve only (E²V or PWM)

4. COMMISSIONING

4.1 Configuration

Once the electrical connections have been completed (see the chapter on Installation) and the power supply has been connected, the operations required for commissioning the controller depend on the type of interface used, however essentially involve setting the so-called initial configuration parameters. See the guided commissioning procedure.

- MXOPZKEYYA0 / IROPZKEYA0 (firmware 1.x) programming key.** MPXPRO can be configured using programming keys that have themselves been programmed. In this case, simply plug the key into the connector. The operation must be performed with the controller off. After loading the parameters the controller can be started.
- Commissioning tool software, VPM.** This procedure is used to program and test the operation of the MPXPRO from a PC during commissioning when starting the system. In particular, this method is used to:
 - set the values, visibility and attributes of all the parameters (including unit parameter);
 - completely program a key;
 - during start-up, monitor and manually override all the inputs/outputs;
 - update the firmware.

The commissioning tool can be connected from the PC via the RS485 supervisor port:

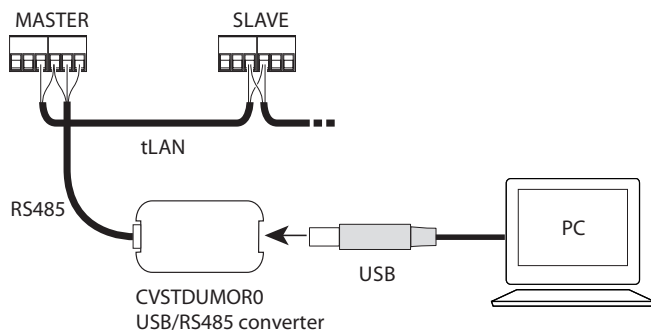

Fig. 4.a

- User terminal.** When first started, MPXPRO activates a special procedure to set the critical parameters for:
 - correct communication of the controller with a supervisor and Master/Slave network;
 - management of the electronic valve.

This procedure can be disabled from the key or commissioning tool (VPM). During this procedure, the device remains in standby and the functions are disabled (including control and communication via RS485 or tLAN). The special configuration menu is only displayed on the user terminal, consequently one needs to be connected if the function is not disabled (avoiding conflicts in the network/LAN or return of liquid refrigerant to the compressor). Only after having set all the required parameters can normal configuration be performed.
- Remote control.** When first started, this can be used to directly configure the critical parameters without needing to activate the synchronization function (synch button).

4.2 Recommended initial configuration

MPXPRO features highly configurable inputs and outputs. CAREL in any case recommends the basic configuration following the default settings of the parameters. By following this suggestion, the controller can independently manage the main functions in most applications, without having to significantly modify the settings of the parameters.

Inputs

The default configuration involves:

Group 1: NTC temperature probes on the showcase:

- S1: NTC outlet probe Sm;
- S2: NTC defrost probe Sd;
- S3: NTC intake probe Sr.

Group 2: superheat control:

- S4/DI1: NTC superheated gas temperature probe on evaporator outlet (configured only on models with valve driver included, see parameter /Fd)
- S5/DI2: input not active;

Group 3: superheat control:

- S6/DI3: ratiometric evaporator pressure probe (configured only on models with valve driver included, see advanced parameters /P3, /U6, /L6, /FE).

Group 4:

- S7: input not active.

Group 5:

- digital input DI5 not active (see parameter A12)

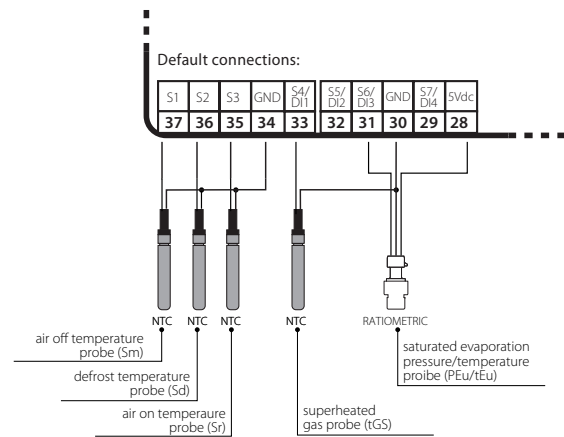

Fig. 4.b

Outputs

The default configuration involves:

- Relay 1: solenoid valve/compressor (see parameter H13);
- Relay 2: light (see parameter H7);
- Relay 3: defrost (not modifiable);
- Relay 4: evaporator fans (see parameter H1);
- Relay 5: alarm (see parameter H5);
- PWM 1: anti-sweat heater control, see paragraph 6.3.
- PWM 2: evaporator fan speed control, see FAN category parameters.

Note: VPM (Visual Parameter Manager) can be used to modify the relay mapping.

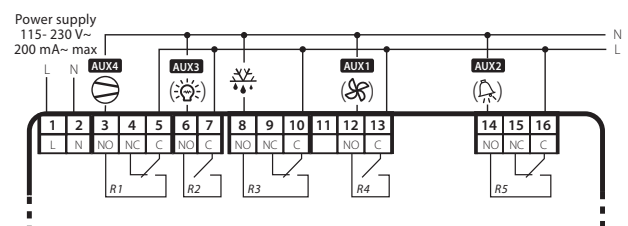

Fig. 4.c

4.3 Guided commissioning procedure (user terminal/remote display)

When first powered up, MPXPRO runs a procedure that guides the user in setting the main parameters for the configuration of the electronic valve and the serial network.

Start-up parameters

Par.	Description
/P2	Type of probe, group 2 (S4, S5)
/P3	Type of probe, group 3 (S6)
/Fd	Assign tGS (superheated gas temperature probe)
/FE	Assign PEu/tEu (saturated evaporation pressure/temperature probe)
/U6	Maximum value of probe 6
/L6	Minimum value of probe 6
P1	Electronic valve
PH	Type of refrigerant
In	Type of unit
Sn	Number of slaves in the local network
H0	Serial or Master Slave network address

Tab. 4.a

The parameters can be configured from the user terminal or the remote control. If using the remote control, a terminal with display and infrared receiver (IR) is required.

After having powered up the controller:

1. the first parameter is displayed: /P2 = type of probe, group 2 (S4, S5);
2. press Set to display the value of the parameter;
3. press UP/DOWN to change the value;
4. press Set to confirm, the "spanner" icon disappears, indicating that the setting has been made;
5. press UP and repeat steps 2, 3, 4 for the following parameters, /P3, /Fd, /FE, /U6, /L6, P1, PH, In, Sn, H0;
6. press Prg/mute for 5 seconds to exit the guided commissioning procedure.

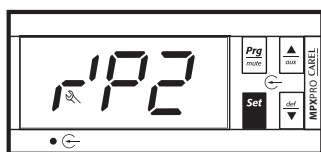

Fig. 4.d

/P2: Type of probe, group 2 (S4,S5)

Used to select the type of temperature probe to be used for inputs S4, S5.

Par.	Description	Def	Min	Max	UoM
/P2	Type of probe, group 2 (S4, S5) 0 = NTC Standard Range -50T90 °C 1 = PTC Standard Range -50T150 °C 2 = PT1000 Standard Range -50T150 °C 3 = NTC L243 Standard Range -50T90 °C	0	0	3	-

Tab. 4.b

Note: NTC L243/PTC/PT1000 probes can only be set in the full optional models or models with EEV driver. To assign the functions to the other probes, see parameters /FA, /Fb, /Fc, /Fd, /FE, /FF, /FG, /FH, /FI, /FL, /FM. For probe calibration, see parameters /c4,/c5.

/P3: Type of probe, group 3 (S6)

Used to select the type of temperature or ratiometric pressure probe to be used for input S6.

Par.	Description	Def	Min	Max	UoM
/P3	Type of probe, group 3 (S6) 0 = NTC Standard Range -50T90 °C 1 = PTC Standard Range -50T150 °C 2 = PT1000 Standard Range -50T150 °C 3 = NTC L243 Standard Range -50T90 °C 4 = 0 to 5V ratiometric probe	0	0	4	-

Tab. 4.c

Note: NTC L243/PTC/PT1000 can only be set in the full optional models or models with EEV driver.

/Fd: Assign tGS (superheated gas temperature probe)

Used to assign the measurement of the superheated gas temperature at the evaporator outlet to the selected probe.

Par.	Description	Def	Min	Max	UoM
/Fd	Assign tGS (superheated gas temperature) 0 = Funct. disab. 6 = Probe S6 1 = Probe S1 7 = Probe S7 2 = Probe S2 8 = Serial probe S8 3 = Probe S3 9 = Serial probe S9 4 = Probe S4 10 = Serial probe S10 5 = Probe S5 11 = Serial probe S11	0	0	11	-

Tab. 4.d

/FE: Assign PEu/tEu (saturated evaporation pressure/temperature probe)

Used to assign the measurement of the saturated evaporation pressure/temperature to the selected probe, which by default is the probe connected to input S6. The 0 to 5 Vdc ratiometric probe is recommended.

Par.	Description	Def	Min	Max	UoM
/FE	Assign PEu/tEu (saturated evaporation pressure/temperature probe) See /Fd	0	0	11	-

Tab. 4.e

/U6, /L6: Maximum / minimum value of probe S6

Parameters /L6 and /U6 are used to adjust the maximum and minimum limits corresponding to the range of measurement for the probe connected to input S6.

Par.	Description	Def	Min	Max	UoM
/U6	Maximum value of probe 6	9.3	/L6	100	barg, RH%
/L6	Minimum value of probe 6	-1.0	-100	/U6	barg, RH%

Tab. 4.f

P1: Type of expansion valve

MPXPRO can control the CAREL E²V electronic valve or PWM valves, depending on the model code.

Par.	Description	Def	Min	Max	UoM
P1	Electronic valve 0 = not used 1 = PWM valve 2 = CAREL E ² V valve	0	0	2	-

Tab. 4.g

PH: Type of refrigerant

The type of refrigerant is essential for calculating the superheat. In addition, it is used to calculate the evaporation and condensing temperature based on the pressure probe reading. Below is the table of refrigerants allowed and their compatibility with the CAREL E²V valve.

Par.	Description	Def	Min	Max
PH	Type of refrigerant 0 = Gas custom 1 = R22, 2 = R134a, 3 = R404A, 4 = R407C, 5 = R410A, 6 = R507A, 7 = R290, 8 = R600 9 = R600a 10 = R717, 11 = R744, 12 = R728, 13 = R1270, 14 = R417A, 15 = R422D, 16 = R413A, 17 = R422A, 18 = R423A, 19 = R407A, 20 = R427A, 21 = R245FA, 22 = R407F, 23 = R32, 24 = HTR01, 25 = HTR02, 26 = R23, 27 = R1234yf, 28 = R1234ze, 29 = R455A, 30 = R170, 31 = R442A, 32 = R447A, 33 = R448A, 34 = R449A, 35 = R450A, 36 = R452A, 37 = R508B, 38 = R452B, 39 = R513A, 40 = R454B	3	0	40

Tab. 4.h

In: Type of unit

Parameter In assigns the controller the function of Master or Slave.

To convert a Master controller to a Slave:

1. set parameter In=0.

To convert a Slave controller to Master:

1. install the RTC and RS485 interface card (MX3OP48500);

2. set parameter In=1.

Par.	Description	Def	Min	Max	UoM
In	Type of unit 0 = Slave; 1 = Master	0	0	1	-

Tab. 4.i

Sn: Number of Slaves in the local network

This parameter tells the Master controller how many Slave controllers it has to manage in the local network. If Sn = 0, it is a stand alone display case. The maximum number of Slave controllers in a subnetwork is 5. On Slave controllers the parameter must be left at 0.

Par.	Description	Def	Min	Max	UoM
Sn	Number of Slaves in the local network 0 = no Slave	0	0	5	-

Tab. 4.j

H0: Serial or Master Slave network address

On a Master controller this represents the address of the controller in the CAREL or Modbus® supervisory network. On a Slave controller, it represents the address of the controller in the local network (1 to 5). In this case, the address in the CAREL or Modbus® supervisory network will be the address of the Master added to the address of the Slave.

Par.	Description	Def	Min	Max	UoM
H0	Serial or Master Slave network address	199	0	199	-

Tab. 4.k

Important: if more than one Master, with their own local networks,

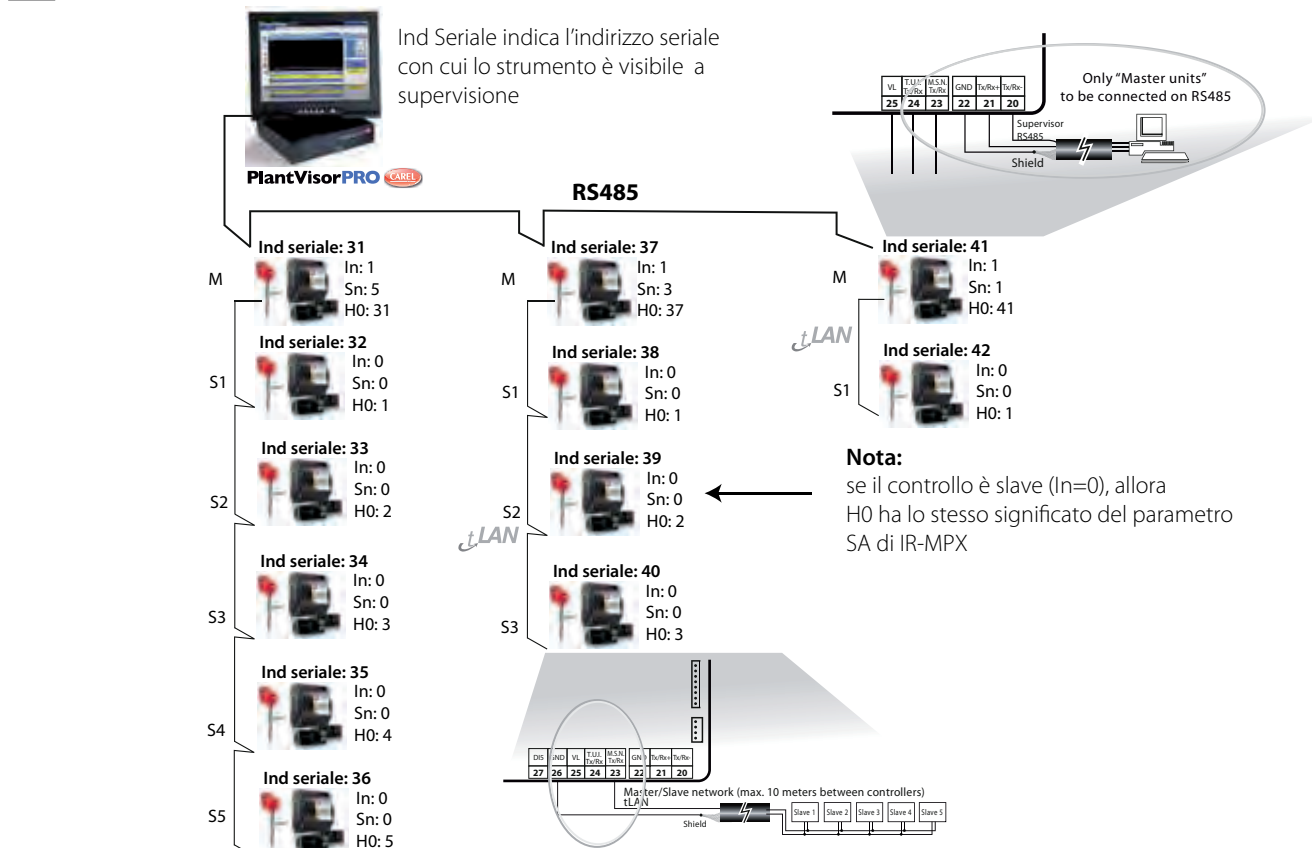

Fig. 4.e

4.4 Checks after commissioning

Once having completed the installation, configuration and programming operations, after commissioning the controller check that:

- the programming logic is suitable to control the unit and the installation in question;
- the day/night time bands have been set correctly;
- the standard display has been set on the user terminal and remote display;
- the unit of measure has been set for the temperature probes (°C or °F);

- the label on the cover of each controller shows:
 - serial address;
 - Master or Slave;
 - the number of Slaves;
 - any remarks.

Important: all the alarms with manual reset can be reset by pressing Prg/mute and UP together for more than 5 seconds. See the chapter on Alarms.

are connected to a supervisor network, the address set for each Master must consider the number of Slaves in the previous network.

Example: to configure the addresses in a supervisor network made up of three Master controllers that manage 5, 3 and 1 Slave controllers respectively.

Solution: assign, for example, the first Master controller serial address H0=31, which also represents the controller address in the supervisor network, the serial address of the second Master controller will be 37 and the third 41.

See the following figure.

Note: only the Master controller must be connected to the RS485 serial line, all Slave controllers communicate with the supervisor via the Master controller over the tLAN.

Note: MPXPRO works with CAREL and Modbus® supervisory network. The controller automatically identifies the protocol type.

5. BASIC FUNCTIONS

5.1 Probes (analogue inputs)

Introduction

MPXPRO features a maximum of 7 analogue inputs and 1 digital input (DI5). Analogue inputs S4, S5, S6, S7 can also be configured as digital inputs, called DI1, DI2, DI3, DI4, by setting parameters A4, A5, A10, A11. Input DI5 can only be used as a digital input, and is configured by parameter A12. See the description of the terminals in paragraph 2.2. The probes (temperature NTC, PTC, PT1000, NTCL243, 0 to 5 Vdc ratiometric and active probes) can be connected to the analogue inputs, and have been divided into 5 groups, with the same type of probe for each group. See the table of parameters.

Types of probes that can be connected to each group

	Group 1	Group 2	Group 3	Group 4	Group 5
Composition	S1, S2, S3	S4, S5	S6	S7	S8, S9, S10, S11
Parameter for type of probe	/P1	/P2	/P3	/P4	/P5
0 = NTC Standard Range -50T90 °C	●	●	●	●	-
1 = PTC Standard Range -50T150 °C	●	●	●	●	-
2 = PT1000 Standard Range -50T150 °C	●	●	●	●	-
3 = NTC L243 Standard Range -50T90 °C	●	●	●	●	-
4 = 0 to 5V ratiometric probe	-	-	●	●	-
5 = 0 to 10V input	-	-	-	●	-
6 = 4 to 20 mA input	-	-	-	●	-
Serial probes	-	-	-	-	●

Tab. 5.a

Inputs S6, S7 can be connected to 0 to 5 V ratiometric pressure probes, remembering however that MPXPRO can only supply one ratiometric probe. Input S7 can nonetheless also be connected to active probes with a 4 to 20 mA or 0 to 10 V output, which cannot be powered directly by MPXPRO. All these probes require the range of measurement to be defined, set by parameters /L6, /U6, /L7, /U7. See the table of parameters.

Probe 6		Probe 7	
Minimum value	Maximum value	Minimum value	Maximum value
/L6	/U6	/L7	/U7

Tab. 5.b

MPXPRO can adjust the values read by the probes. In particular, /c1 to c7 are used to increase or decrease the physical values read by the probes, if configured as temperature probes. Parameter /cE, on the other hand, corrects the value of the saturated evaporation temperature calculated directly based on the evaporation pressure. The serial probes cannot be calibrated, while the probes shared with the Master (such as the pressure probe) are calibrated by the Master. To assign the functions to each physical or serial probe, set parameters /FA, /Fb, ... /Fn. See the table of parameters.

Probe	Parameter	Probe	Parameter
Outlet	/FA	Auxiliary temperature 1	/FG
Defrost	/Fb	Auxiliary temperature 2	/FH
Intake	/Fc	Ambient temperature	/FI
Superheated gas temperature tGS	/Fd	Ambient humidity	/FL
Saturated evaporation temperature tEu	/FE	Glass temperature	/FM
Defrost probe 2	/FF	Dewpoint	/Fn

Tab. 5.c

One single pressure probe can be shared across the Master – Slave network. This must be connected to the Master. On the Master, simply correctly configure the using the parameters /FE, /U6, /L6, while on the Slaves, set /FE=0 (function disabled). In this way, the Slaves automatically search for the pressure value shared by the Master and used for calculating the local superheat. This is used to save on the installation costs of a pressure probe for each evaporator, assuming that the pressure drop in that section of the line is negligible.

Probe positioning and purchase codes

The following probes are recommended by CAREL:

- evaporator outlet temperature probe: NTC***HF01;
- evaporation pressure probe:
 - SPKT0013R0: ratiometric -1 to 9.3 bars;
 - SPKT0053R0: ratiometric -1 to 4.2 bars;
 - SPKT0033R0: ratiometric -1 to 34.5 bars.
 - SPKT0053R0: raziometrica -1.0...4.2 bar;
 - SPKT0013R0: raziometrica -1.0...9.3 bar;
 - SPKT0043R0: raziometrica 0.0...17.3 bar;
 - SPKT0033R0: raziometrica 0.0...34.5 bar;
 - SPKT00B6R0: raziometrica 0.0...45.0 bar;
 - SPKT0011S0: raziometrica -1...9.3 bar;
 - SPKT0041S0: raziometrica 0...17.3 bar;
 - SPKT0031S0: raziometrica 0...34.5 bar;
 - SPKT00B1S0: raziometrica 0...45.0 bar;
 - SPKT00G1S0: raziometrica 0...60.0 bar.
- case ambient temperature probe: NTC***HP00;
- ambient temperature and humidity probe:
 - DPWC111000: 4 to 20 mA;
 - DPWC115000: 0 to 10 Vdc;
 - DPWC114000: RS485 serial probe.

The temperature and humidity probes must not be positioned too far from the showcases they are measuring. At times it is better to install more than one if the supermarket is divided into sections with greatly differing temperature and humidity values (frozen section, meat section, fruit and vegetable section, etc.)

- **glass temperature probe:** NTC060WG00. The glass temperature probe is connected at the coldest point of the glass on the showcase, so as to optimise operation of the anti-sweat device (heaters or fans). See instruction sheet +050002005.
- For further information see the instruction sheets that can be downloaded, even prior to purchase, from www.carel.com.

Assign probe functions (parameters /FA, /Fb, /Fc)

Par.	Description	Def	Min	Max	UoM
/FA	Assign outlet temperature probe (Sm)	1	0	11	-
	0 = Funct. disab. 6 = Probe S6				
	1 = Probe S1 7 = Probe S7				
	2 = Probe S2 8 = Serial probe S8				
	3 = Probe S3 9 = Serial probe S9				
	4 = Probe S4 10 = Serial probe S10				
	5 = Probe S5 11 = Serial probe S11				
/Fb	Assign defrost temperature probe (Sd) See /FA	2	0	11	-
/Fc	Assign intake temperature probe (Sr) See /FA	3	0	11	-

Tab. 5.d

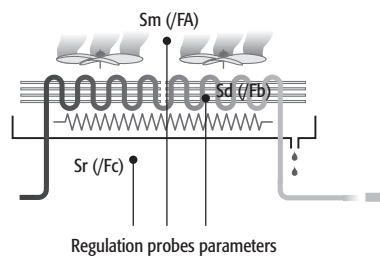

Fig. 5.a

MPXPRO, inside the showcase or cold room, can use temperature probes to measure:

- the air outlet temperature (evaporator outlet);
- the defrost temperature (in contact with the evaporator);
- the air intake temperature (evaporator inlet).

The default configuration for the assignment of the control probes is as follows:

- S1 = Outlet probe (Sm);
- S2 = Defrost probe (Sd);
- S3 = Intake probe (Sr).

The default configuration also involves these three probes being standard CAREL NTC. However, other types of probes can be connected by setting parameter /P1, if the product code allows that. On MPXPRO the default settings can be changed to choose the function associated with any of the probes connected. There are also cases where the characteristics of the applications require different settings.

Examples:

Control inside a cold room is normally performed using just two temperature probes, in particular the intake temperature is not read. In this case, the possible configuration may be:

- /FA=1: outlet temperature on probe S1 (Sm=S1);
- /Fb=2: defrost temperature on probe S2 (Sd=S2);
- /Fc=0: no intake temperature;

Alternatively:

- /FA=1: outlet temperature on probe S1 (Sm=S1);
- /Fb=3: defrost temperature on probe S3 (Sd=S3);
- /Fc=0: no intake temperature.

Share control status

This function is used to satisfy the needs of cold rooms or showcases with multiple evaporators, where the Slaves are essentially used as expansions for the management of different electronic valves. This function shares the Master control status across the tLAN network. In this way, the Master determines the control status, and each Slave operates as a consequence, without consider the parameters set locally. This means Slave controllers can be used without outlet and intake probes. If the Slave controller is not accessible from the Master, "duty setting" operating mode must be activated, setting the corresponding parameter c4 >0.

Activation: to activate sharing of the control status, set /FA = 0 and /Fc = 0 on the controllers MPXPRO Slave.



Note:

- the configuration /FA = 0 and /Fc = 0 on a Master controller causes the alarm 'rE';
- if the Slave controller is not accessible from the Master, alarm 'MA' is displayed.

The function manages the control status (activation and deactivation of the cooling request) on the Slave controllers from the Master via the tLAN network. This means that only the Master parameters (set point, differential, night-time set point variation, control offset in the event of probe error) affect the control algorithm. The value of the Slave parameters has absolutely no influence. If the Slave controller is not accessible from the Master (the user interface shows alarm 'MA'), "duty setting" mode is activated based on the local setting of parameter c4, and the corresponding management (duty setting starts in the status found prior to the instant it is activated, i.e. it starts with compressor on if this was on, and with compressor off if it was off).



Note: activation of the **continuous cycle** on the Master means all the dependent Slave observe the compressor management times of the Master controller (only parameter cc on the Master has an effect, while the values set on the Slaves are ignored). This operating mode is only highlighted on the Master user terminal, as the Slave controllers ignore the Master control mode. This means that a Slave controller serving the Master, even in the continuous cycle, manages the user interface as if it were in normal control (compressor icon on during cooling request and off when no request). Attempts to activate continuous cycle on a Slave serving the Master are ignored, both local and sent from the Master.



Note: if the Master controller enters **duty setting** mode, the related Slave controllers follow as regards the compressor management times and the user interface does not show the icon flashing when the compressor is off, due to the fact that they ignore the Master control mode. On the other hand, if the Slaves enter duty setting mode due to lack of communication with the Master; in this case they manage the user interface correctly.

Calibration (parameters /c1, /c2, /c3)

MPXPRO can adjust the values read by the probes and some of the internal variables. In particular, /c1 to /c3 are used to increase or decrease the values read by the physical probes connected to the inputs S1, S2, S3, if configured as temperature probes. Parameter /cE, on the other hand, corrects the value of the saturated evaporation temperature calculated directly based on the evaporation pressure. The serial probes cannot be calibrated, while the probes shared with the Master are calibrated by the Master.

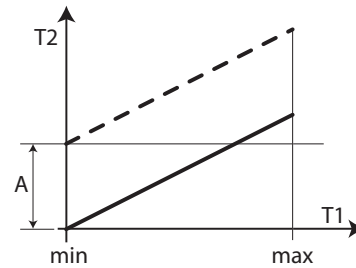

Fig. 5.b

Key

- T1 Temperature read by the probe
- T2 Value calibrated by T1
- A Offset
- min, max Range of measurement

Par.	Description	Def	Min	Max	U.O.M.
/c1	Probe 1 calibration	0	-20	-20	(°C/°F)
/c2	Probe 2 calibration	0	-20	-20	(°C/°F)
/c3	Probe 3 calibration	0	-20	-20	(°C/°F)

Tab. 5.e



Note: modification of parameters that affect temperature measurement and display may not be allowed in certain applications (e.g.: HACCP).

5.2 Digital inputs

Introduction

MPXPRO manages up to 5 physical digital inputs and one virtual digital input. Of these, as already mentioned, DI1, DI2, DI3, DI4 are analogue/digital inputs, configured as digital inputs by their respective parameters A4, A5, A10, A11, while DI5 is only a digital input and can be configured using parameter A12.

See the general connection diagram in paragraph 2.8.

The virtual digital input is a function whereby the status of a digital input is propagated via tLAN from Master to Slave. This is useful, for example, for a curtain switch, allowing switching from day to night status and vice-versa without having to connect additional wiring from the Master to the Slaves. The virtual digital input can be configured from the supervisor or the Master, based on the setting of parameter A9 (only settable on the Master). A physical input on the Master can be associated with the virtual digital input on the Master, to be propagated to the Slaves. This is some using a parameter, either A4, A5, A10, A11 or A12 (based on the setting of A9) set on the Master, and parameter A8 set on the Slave. See the advanced parameters explained in paragraph 6.2.



Note: if needed, parameter A8 can have different settings on the Slaves, so as to activate different functions.

The table below lists the various functions that can be activated by digital input, when closing or opening the corresponding contact.

Digital inputs

	S4/DI1	S5/DI2	S6/DI3	S7/DI4	DI5
Parameter	A4	A5	A10	A11	A12

Functions of the digital inputs (Parameters A4, A5, A10, A11, A12)

Selection	Contact	
	open	closed
0 = input not active	-	-
1 = immediate external alarm	active	not active
2 = delayed external alarm	active	not active
3 = enable defrost	not enabled	enabled
4 = defrost call	not active	active
5 = door switch	door open	door closed
6 = remote ON/OFF	OFF	ON
7 = curtain switch/light	day status	night status
8 = start/stop continuous cycle	not active	active
9 = digital input monitoring	active	not active
10 = timed digital input	active	not active
11 = switch in Standby status	active	not active
12 = switch in Clean status	active	not active
13 = change working set	set 1	set 2
14 = door switch without stopping control	door open	door closed

Tab. 5.f

If the opposite logic to the default setting is required, or to correct a wiring error, the logic of the functions associated with the digital inputs using parameters Hr1, Hr2, Hr3, Hr4, Hr5 can be reversed.

Par.	Description	Def	Min	Max	UoM
Hr1, Hr5	Reverse logic for digital input 1, 5	0	0	1	-

Tab. 5.g



Note: reverse logic does not affect virtual DI.

1 = Immediate external alarm

Activation of the alarm causes:

- message 'IA' shown on the display and alarm icon (triangle) flashing;
- activation of the buzzer (to configure this function, see parameter H4);
- activation of the alarm relay (if configured, see parameters H1, H5, H7);
- deactivation of the compressor/solenoid output (to configure this function, see parameter A6).



Note: activation of the external alarm shuts down the evaporator fans only if these follow the status of the compressor output, as set for parameter F2. When the compressor is shut down due to an external alarm the compressor ON time is ignored (parameter c3).

2 = Delayed external alarm

The operation of this alarm depends on the setting of parameter A7 (delay time for delayed external alarm):

- A7=0: signal only alarm on the display, normal operation of the controller is not affected (default);
- A7≠0: alarm similar to the immediate external alarm, activation is delayed by the time set for A7.

3 = Enable defrost

Used to disable any defrost calls. When the contact is open, all defrost calls are ignored. Parameter d5 can be used to delay activation.



Note:

- if the contact is open while a defrost is in progress, this is immediately stopped, the defrost icon flashes on the display indicating the defrost call is active (this starts again when the contact closes);
- this function may be useful to prevent defrosts on controllers exposed to the public during store opening hours, and to be able to perform special hot gas defrosts.

4 = Defrost call

The closing of the digital contact starts the defrost, if enabled. In the event of Master Slave network connection, if the controller is the Master, the defrost will be a network defrost, while if it is a Slave, it will only be a local defrost. The defrost digital input can be used effectively to perform real time defrosts. Simply connect a timer to the multifunction digital input on the Master and use d5 to delay the defrosts on the various Slaves and thus avoid current overloads.



Note: if the defrost is inhibited by another digital input configured as "enable defrost", the defrost calls are ignored.

5 = Door switch

Door open:

- stop control (shutdown compressor/solenoid and evaporator fans); alternatively, control can be kept active using function 14 (see the description below);
- switch light on (if configured, see parameters H1, H5, H7, H13);
- alarm icon (triangle) flashing on the display;
- disable temperature alarm.

Door closed:

- resume control;
- switch light off (if configured, see parameters H1, H5, H7, H13) with settable delay using parameter H14
- triangle icon stops flashing on the display;
- enable temperature alarm after bypass time defined by parameter Add.

Par.	Description	Def	Min	Max	UoM
H14	Time light kept on after closing the door	0	0	240	min

Tab. 5.h

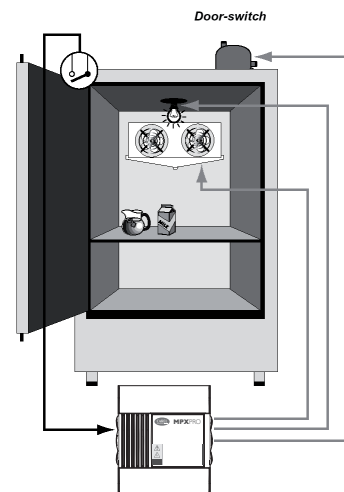

Fig. 5.c



Note:

- when resuming control, the compressor protection times are observed (see the advanced functions, compressor parameters);
- if the door remains open for a time greater than the value set for parameter Add, control is resumed in any case. The light remains on, the value shown on the display flashes, the buzzer and the alarm relay are activated, and the temperature alarms are enabled, with the delay Ad.

Par.	Description	Def	Min	Max	UoM
Add	Bypass high temperature alarm for door open	30	1	240	min

Tab. 5.i

6 = Remote ON/OFF

When the controller is OFF:

- the display shows the value measured by the probes set (parameter /t1) alternating with the message OFF;
- the auxiliary relays set as AUX and light remain active, while the other auxiliary outputs are deactivated;
- the buzzer and alarm relay are deactivated;
- the following are not performed: control, defrosts, continuous cycle, temperature alarm signals;
- the compressor protection times are observed;
- switching ON from the keypad, supervisor or remote control is ignored.

When the controller is ON again, all the functions are reactivated, except for the defrost on start-up and compressor and evaporator fan delay on power-up (parameter c0).



Note:

- if more than one input is configured as the remote ON/OFF, the off status of one any of these determines the off status of the device;
- the FF control from digital input has priority over the keypad and the supervisor;
- if the controller remains OFF for longer than the value set for basic parameter dl, when the controller is switched back on a defrost is performed.

7 = Curtain switch/light

During night status:

- the night-time set point Stn is used for control, calculated based on the set point St plus the offset defined by parameter r4 (Stn = St + r4). In addition, if necessary the control probe is changed based on the configuration of parameter r6 (0 = virtual probe, 1= intake probe);
- the AUX or light output is deactivated based on the setting of parameter H8.

During day status:

- normal operation resumes: set point = St, virtual probe used as control probe;
- activation of the AUX or light output based on the setting of parameter H8.

Par.	Description	Def	Min	Max	UoM
H8	Output switched with time bands 0 = Light; 1 = Aux.	0	0	1	-

Tab. 5.j

8 = Continuous cycle

When the contact closes the continuous cycle is activated, parameters cc and c6 (see the Advanced functions). The continuous cycle ends when the contact opens again.

9 = Digital input monitoring

The supervisor can detect digital input status. The value is not affected by reversing the logic of the input using parameters Hr1 to Hr5.

10 = Timed input (timer)

The timed digital input is a special configuration for the digital inputs on MPXPRO that allows, in the transition from not active to active, to maintain the activation status of a specific digital variable on the supervisor for a time set by parameter.

To enable the function, set the multifunction digital input configuration parameters (A4, A5, A10, A11, A12) to 10.

When a digital input is configured as a timed digital input and a transition occurs from not active to active, the S_DIT_MIRROR "Timer" supervisor variable is set to ON and remains ON regardless of the physical status of digital input for the time set by parameter dlt. Parameter dlt can be set from 0 to 999 minutes. Setting parameter dlt to 0 disables the function. The "Timer" variable can be associated with one or more AUX digital outputs (relays) by suitably setting the related parameters H1, H5, H7, H13 to the value 13, thus aligning them with the status of the "Timer" variable. The timed digital input can be controlled not only by a physical digital input but also from the supervisor using the related digital control variable, with the same result. The same function can be used to set the "Timer" variable OFF regardless of whether or not the time set for parameter dlt has elapsed.

Special features:

- when the "Timer" variable is ON following the rising edge of a digital input, another transition from OFF to ON of the same digital input resets the timer;
- more than one digital input can be configured as a timed digital input: the rising edge of one of the digital inputs will set the "Timer" variable to ON, a new rising edge of another digital input will reset the timer;
- as more than one AUX output can be set at the same time to replicate the "Timer" variable, following a transition in the latter, all the AUX outputs will switch at the same time

Par.	Description	Def	Min	Max	UoM
A4	10 = Timed input	0	0	14	-
dlt	Timer duration	0	0	999	min
H1	Output associated with the timer function	8	0	14	-

Tab. 5.k

11 = switch in Standby status

Standby status is an intermediate state between ON and OFF: control is interrupted, the expansion valve is closed (0%), the control alarms and probe alarms remain active. ON status (normal operation) resumes after the time Stt has elapsed, after switching off (OFF status) or when the controller is restarted.

12 = switch in Clean status

Clean status is an intermediate state between ON and OFF: control is interrupted, the expansion valve is closed (0%), and only the probe alarms remain active. ON status (normal operation) resumes after the time CLt has elapsed, after switching off (OFF status) or when the controller is restarted.

Par.	Description	Def	Min	Max	UoM
CLt	Maximum time for Clean status	0	0	999	min
Stt	Maximum time for Standby status	0	0	240	min

Tab. 5.l

The meaning of OFF, ON, Standby and Clean is summarised in the following table:

	OFF	ON	Standby	Clean
Control	OFF	ON	OFF	OFF
Light	independent	independent	independent	independent
Probe alarms	enabled	enabled	enabled	enabled
Other alarms	disabled	enabled	enabled	disabled
Display	OFF		Stb	CLn

Tab. 5.m

13 = change working set

The set of parameters can be changed by digital input if set to 13. In this case, not all the sets available can be selected, rather just set 1 (digital input not active) and 2 (digital input active). The changeover between sets occurs during the transition in status.

14 = door switch without stopping control

Operating mode for digital inputs that allows the door to be opened without stopping control.

In this case, when opening the door, MPXPRO will only switch on the light.

This operating mode can be configured by setting the parameters corresponding to the digital inputs (A4, A5, A10, A11, A12) to 14.

Opening the door introduces a temperature alarm delay as described for function 5.

Par.	Description	Def	Min	Max	UoM
A4	14 = door switch without stopping control	0	0	14	-

Tab. 5.n

5.3 Analogue outputs

The most complete version of MPXPRO (see paragraph 1.1, Models) features the following analogue outputs: 2 PWM outputs, used as a control signal to manage loads such as modulating evaporator fans or anti-sweat heaters. The first output (PWM1) is connected to phase-cutting speed controller (CAREL code MCHRTF****), the second (PWM2) to the solid state relay (SSR) output.

MPXPRO can also be fitted with a driver for stepper electronic expansion valves or a driver for PWM electronic expansion valves. In this case, the driver cards, as well as the valve control outputs, also have an additional 0 to 10 Vdc output, which can be used to control variable speed evaporator fans (brushless or other types with 0 to 10 V input).

5.4 Digital outputs

The most complete version of MPXPRO (see paragraph 1.1, Models) features 5 digital outputs, called R1, R2, R3, R4, R5. Of these, only R3 is used for defrost management, the other 4 output, called auxiliary outputs (AUX), can be configured by parameters. See the table below.

Output	Relay	Parameter	Default function
AUX1	R4	H1	Evaporator fan output
AUX2	R5	H5	Normally energized alarm output
AUX3	R2	H7	Light output
AUX4	R1	H13	Solenoid output

Tab. 5.o

Functions of the digital outputs (Parameters H1, H5, H7)

0	No function	7	Auxiliary evaporator defrost
1	Normally de-energized alarm	8	Evaporator fans
2	Normally energized alarm	9	Anti-sweat heaters
3	Auxiliary	10	Suction valve
4	Auxiliary serving the Master on the Slaves	11	Equalizing valve
5	Light	12	Liquid solenoid valve (*)
6	Light serving the Master on the Slaves	13	Output associated with the timer function
		14	Condensate drain heaters

Tab. 5.p

(*) only for R1-AUX4

Normally de-energized/normally energized alarm

With reference to the general connection diagram in paragraph 2.8, outputs AUX1, AUX2 or AUX3, configured as alarm output, can work as:

- normally de-energized: the relay is energized when an alarm occurs;
- normally energized: the relay is de-energized when an alarm occurs;

Note: operation with the relay de-energized when an alarm occurs ensures maximum safety when the alarm is due to a power failure or disconnection of the power cables.

Auxiliary / light (H1, H5, H7 = 3/5)

The actuator can be activated/deactivated using the UP/aux button, controlled from the supervisor and based on the changeover in day/night status (linked to the curtain switch or the setting of the time bands); activation/deactivation of the actuator is signalled by the "Light" icon if the auxiliary output is configured as the light output (H1, H5, H7=5) and H9=0, or the AUX icon if the AUX output is configured as the auxiliary output (H1, H5, H7= 3) and H9=1. The light or AUX output to be activated or deactivated based on the night/day time band can be selected (see parameters tS1...8 and tE1...8).

Par.	Description	Def	Min	Max	UoM
H9	Select function associated with the "aux" button on the user terminal 0 = Light 1 = AUX.	0	0	1	-

Tab. 5.q

Auxiliary / light serving the Master on the Slaves (H1, H5, H7 = 4/6)

From the Master, the action of the auxiliary output is propagated via tLAN to the Slaves whose digital output is configured as H1=4, for the auxiliary output, and H1=6 for the light output.

Condensate drain management in defrost (H1, H5, H7, H13 = 14)

During defrost there may be frozen condensate on the bottom of the cabinet that prevents the water dissolved by the evaporator from being drained correctly.

The digital outputs (H1, H5, H7, H13) can be configured to manage the condensate drain heater function. The heater is started on activation of the pump down stage and stays on throughout the defrost procedure, until the end of the dripping phase.

The heater can be activated by setting one of the parameters corresponding to the digital auxiliary outputs (H1, H5, H7, H13) to 14.

Note: the heater must be protected against overheating (e.g.: thermal protector).

Auxiliary evaporator defrost (not compatible with electronic expansion valve management)

A heater can be activated to perform a heater defrost on the main and auxiliary evaporator.

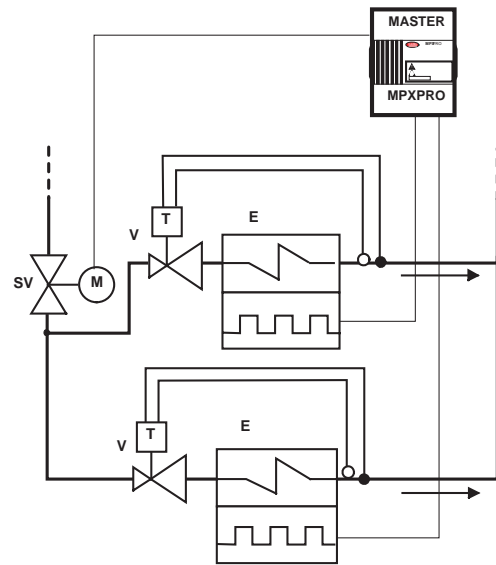

Fig. 5.d

Key

- E Evaporator with electric defrost
- V Thermostatic expansion valve
- SV Solenoid valve

MPXPRO can manage defrosts with one or two outputs and one or two end defrost probes. The table below summarises the possible cases:

Defrost outputs	Evaporator probes	Control
1	1	normal
2	1	defrost managed on two outputs with reference to the same evaporator probe
1	2	defrost managed on the same output with reference to two evaporator probes (minimum evaporation temperature)
2	2	defrost managed independently on the two evaporator circuits

Tab. 5.r

Par.	Description	Def	Min	Max	UoM
Sd1	Defrost probe	-	-	-	°C/°F
Sd2	Secondary evaporator defrost probe	-	-	-	°C/°F

Tab. 5.s

Evaporator fans

This configuration involves using the auxiliary output for the evaporator fans; the activation/deactivation of the evaporator fans is signalled by the evaporator fan icon on the display. See paragraphs 5.7 and 6.8.

Anti-sweat heaters

This configuration involves using the auxiliary output to demist the display cases (control with fixed activation, see paragraph 6.3).

Suction and equalizing valve

This configuration involves using the auxiliary output as a suction or balancing valve for hot gas defrosts. See paragraph 5.6.

Liquid solenoid valve

Available only for R1 AUX4 (modifiable only with H13), used to activate the liquid solenoid valve when ultracap technology is not available or in applications with thermostatic valves.

Note: the solenoid function in the instrument is always active, even if the corresponding output is not configured. The icons and variables on the supervisor will thus reflect normal operation of the instrument

5.5 Control

Introduction

There are various modes for controlling air temperature for the conservation of foodstuffs in cold rooms and showcases. The following figure shows the position of the intake probe Sr and the outlet probe Sm. The virtual probe Sv is a weighted average of these two, based on parameter /4, according to the following formula:

$$Sv = \frac{Sm \cdot (100 - /4) + Sr \cdot (/4)}{100}$$

Par.	Description	Def	Min	Max	UoM
/4	Virtual probe composition 0 = outlet probe Sm 100 = intake probe Sr	0	0	100	%

Tab. 5.t

For example if /4=50, Sv=(Sm+Sr)/2 represents the estimated value of the air temperature around the food being cooled.

Example: vertical showcase

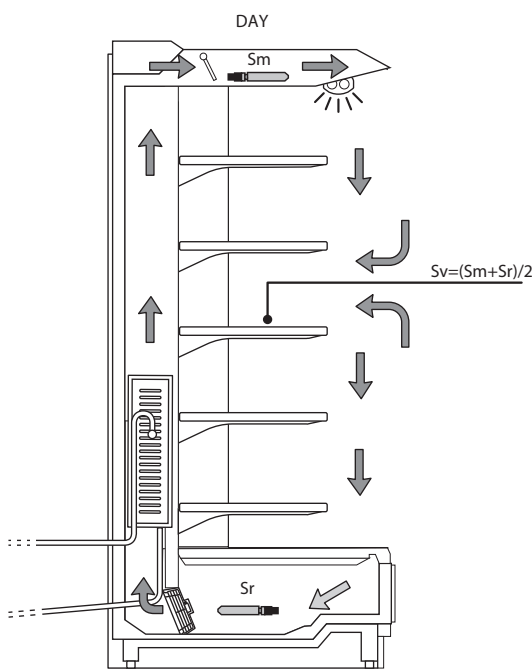

Fig. 5.e

Sm	Outlet probe	Sv	Virtual probe
Sr	Intake probe		

During the day most of the load of the showcase is due to the warm air that enters from the outside and mixes with the cool air inside. Control based on the intake probe, due to high temperature outside the showcase and the mixing of the air, may not manage to reach the set point. Displaying the intake temperature would show a temperature that is too high. Setting a set point that is too low for the intake probe Sr may cause the food to freeze. On the other hand, displaying the outlet temperature would show a temperature that is too low. Consequently, the display of the control probe, set point or virtual probe can be configured using parameters /t1 and /t2.

ON/OFF control on the outlet probe is defined by:

- set point;
- differential.

These values determine the control request and consequently, allowing for the protection times, disabling functions or activation/deactivation delays, the activation and deactivation of the compressor.

Par.	Description	Def	Min	Max	UoM
St	Set point	50	r1	r2	°C/°F
rd	Set point differential	2	0.1	20	°C/°F

Tab. 5.u

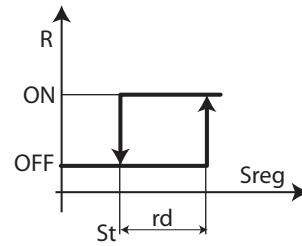

Fig. 5.f

Key

St	set point	Sreg	control probe
rd	differential	R	control request

ON/OFF control depends on the capacity of the produce to absorb and release heat, as well as on the evaporator cooling time. The temperature therefore fluctuates above and below the set point, and this may cause a decline in the quality of food conservation. Decreasing the differential to make control more precise increases the frequency at which the compressor starts and stops and therefore additional wear. Precision of the measurement is in any case limited by the tolerance of both the controller and the probe.

Night-time operation

During night-time operation the curtain on the display case is closed and consequently less cold inside air is mixed with warm outside air. The thermal load decreases. The temperature of the air that cools the produce is near the outlet temperature, and therefore to avoid excessively low temperatures and reduce energy consumption, the set point needs to be increased at night, by setting parameter r4. Parameter r6 can then be used to possible the virtual probe Sv or intake probe Sr as the control probe. Naturally, the change to night-time operation must be signalled externally. This is usually done using the curtain switch, set with the parameters relating to the digital inputs (A4, A5, A10, A11, A12), signalling that the curtain has been lowered, or by setting the time bands (parameters tS1 to tS8 and tE1 to tE8), from the supervisor, or from the Master controller via the Master/Slave network. For time bands setting, see par. 3.4.

Par.	Description	Def	Min	Max	UoM
r4	Automatic night-time set point variation	0	-50	50	°C/°F
r6	Probe for night-time control 0 = virtual probe Sv; 1 = intake probe Sr	0	0	1	-
tS1 to 8	Start time band 1 to 8 day	-	-	-	-
tE1 to 8	End time band 1 to 8 day	-	-	-	-

Tab. 5.v

Variable	Daytime control	Night-time control	
		r6=0	r6=1
Control probe (Sreg)	Virtual probe (Sv)	Virtual probe (Sv)	Intake probe (Sr)
Set point	St	St+r4	

Tab. 5.w

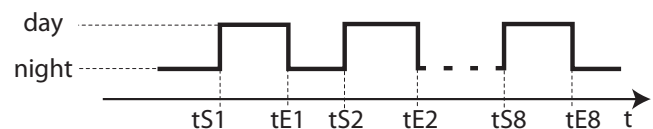

Fig. 5.g

During the daytime:

- Setpoint= St
- light on
- control on virtual probe Sv

During the nighttime:

- Setpoint= St+r4
- light off
- control on Sr (if r6= 1) or on Sv (if r6= 0)

“Weighted control” and “double thermostat” can be used for automatic changeover to night-time operation without an external signal.

Weighted control

This function compensates for the disadvantages of control based solely on the outlet probe or the intake probe. The control probe becomes the virtual probe:

$$Sv = \frac{Sm \cdot (100 - /4) + Sr \cdot (/4)}{100}$$

The weighted average of the outlet and intake probes is used to compensate for the mixing of air from outside the display case. Normally the weight of /4 is set to 50% and the value of the virtual probe can be chosen for both display and temperature recording.

The value of the virtual probe thus becomes the mean value of the outlet and intake probes and the measurement that best corresponds to the temperature of the produce. Another advantage is automatic adaptation to night-time operation with the curtain closed, without needing an external signal. When the curtain is open there is immediately an increase in load on the evaporator, consequently the outlet temperature is lowered so as to keep the average temperature constant.

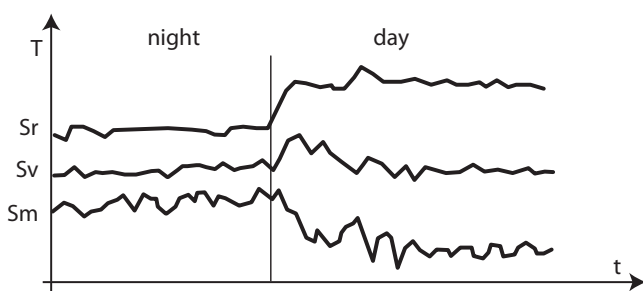

Fig. 5.h

Key
 T temperature
 t time
 Sr intake probe
 Sv virtual probe
 Sm outlet probe

Double thermostat and control with electronic valve

See paragraph 6.5.

Shared network solenoid

If using solenoid valves, on Master controllers only the solenoid output (relay 1 - AUX4) can be configured as a network solenoid output. The function is useful for multiplexed showcases: the network solenoid valve is only connected to the Master controller, which opens when at least one of the Slaves is in cooling request.

Par.	Description	Def	Min	Max	UoM
r7	Master solenoid valve configuration 0 = local valve; 1 = network valve (connected to Master)	0	0	1	-

Tab. 5.x

If configured as the network solenoid, the valve is:

- open: if at least one of the controllers requires cooling;
- closed: if there is no control request or if at least one of the controllers has a serious valve alarm (low superheat, low suction temperature, high evaporation pressure), when suitably configured. See parameters P10 and PM5 (paragraph 6.10).

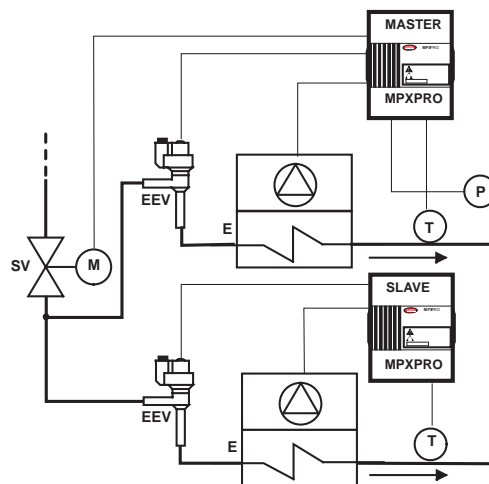

Fig. 5.i

Key
 E Fan-forced evaporator
 SV Solenoid valve
 EEV Electronic expansion valve
 P Evaporation pressure (PEu)
 T Superheated gas temperature (tGS)
 C Condenser

5.6 Defrost

Introduction

Parameters td1 to td8 can be used to set up to 8 defrost events based on the controller clock (RTC) and to activate the Power Defrost (see par. 6.7)

Par.	Description	Def	Min	Max	UoM
td1 to 8	Defrost 1 to 8 (press Set)	-	-	-	-
d_	Defrost 1 to 8 - day	0	0	11	day
h_	Defrost 1 to 8 - hour	0	0	23	hour
n_	Defrost 1 to 8 - minute	0	0	59	min
P_	Defrost 1 to 8 - power defrost activation	0	0	1	-

Tab. 5.y

MPXPRO can manage the following types of defrost, depending on the setting of parameter d0:

1. heater, located near the evaporator;
2. hot gas;
3. multiplexed hot gas.

The defrost can end by temperature, in which case the defrost probe Sd must be installed, or by time. In the first case the defrost ends when the defrost probe Sd exceeds the end defrost value dt1 or the time dP1 has elapsed, in the second case when the defrost phase exceeds the maximum time dP1. At the end of the defrost the dripping phase may begin (if dd>0), during which the compressor and the fans are off, followed by the post-dripping phase (if Fd>0), during control resumes with the fans off. See the chapter on Advanced functions.

The type of display on user terminal and the remote display during the defrost can be selected by setting parameter d6.

Par.	Description	Def	Min	Max	UoM
dt1	End defrost temperature (read by Sd)	8	-50.0	50.0	°C/°F
dP1	Maximum defrost duration	45	1	240	min
d0	Type of defrost 0 = heater by temperature 1 = hot gas by temperature 2 = heater by time 3 = hot gas by time 4 = heater by time with temp. control 5 = multiplexed hot gas by temperature 6 = multiplexed hot gas by time	0	0	6	-
d6	Display on terminals during defrost 0 = temperature alternating with 'dEF' 1 = freeze display 2 = 'dEF'	1	0	2	-
d8	Bypass high temperature alarm time after defrost	30	1	240	min

Tab. 5.z

Below is the trend of the defrost output based on the setting of parameter d0.

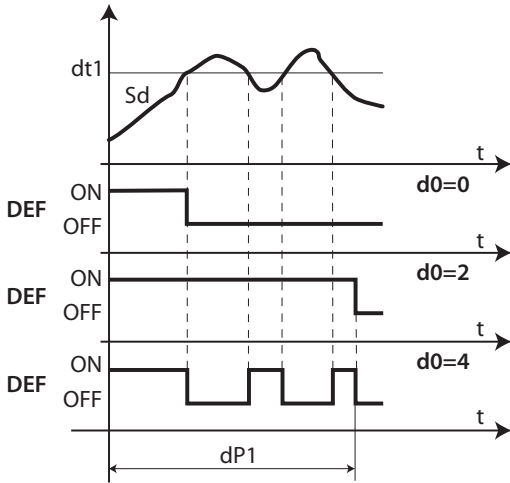

Fig. 5.j

Key

t	Time	Sd	Defrost probe
dt1	End defrost temperature	DEF	Defrost
dP1	Maximum defrost duration		

The heater defrost by time with temperature control (d0=4) activates the defrost output only if the evaporator temperature (Sd) is less than the value of parameter dt1, and ends after the time defined by dP1. This function is useful for energy saving.

1. Heater defrost (d0 = 0, 2, 4): duty cycle

The duty cycle refers to the default values of parameters F2 and F3. The valve can be opened to the initial value set for cP1 for a period equal to Pdd.

2. Hot gas defrost (d0 = 1, 3): duty cycle

The duty cycle refers to the default values of parameters F2 and F3. The valve can be opened to the initial value set for cP1 for a period equal to Pdd.

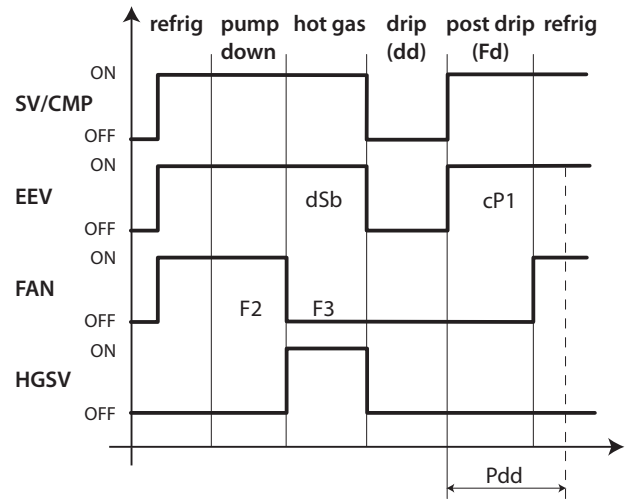

Fig. 5.l

Key

t	Time	SV/CP	Solenoid / Compressor
FAN	Fan	EEV	Electronic expansion valve
HGSV	Hot gas valve	Pdd	Valve position maintenance time after defrost
drip	dripping	post drip	post dripping

The pump down phase is the period in which the evaporator is emptied of liquid refrigerant, and can be disabled by setting dH1=0. See the chapter on Advanced functions. The operation of the fan during the Pump down and Hot gas phases depends on parameters F2 and F3. During the dripping and post-dripping phases, it is always off.

3. Multiplexed hot gas defrost (d0 = 5, 6) : duty cycle

The duty cycle refers to the default values of parameters F2 and F3. The valve can be opened to the initial value set for cP1 for a period equal to Pdd.

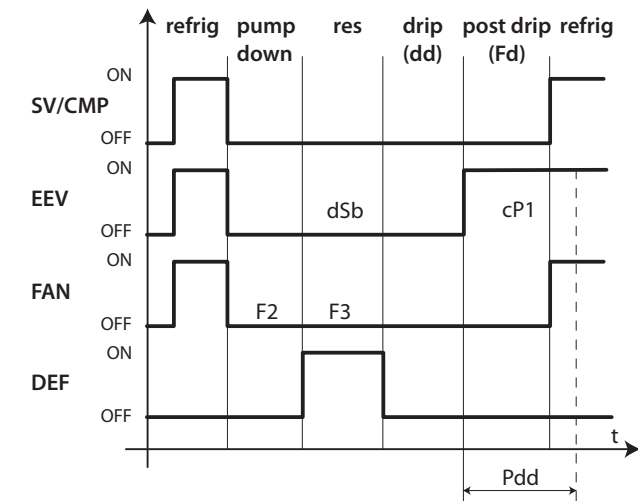

Fig. 5.k

Key

t	Time	SV/CMP	Solenoid / compressor
FAN	Fan	EEV	Electronic expansion valve
DEF	Defrost	Pdd	Valve position maintenance time after defrost
drip	dripping	post drip	post dripping

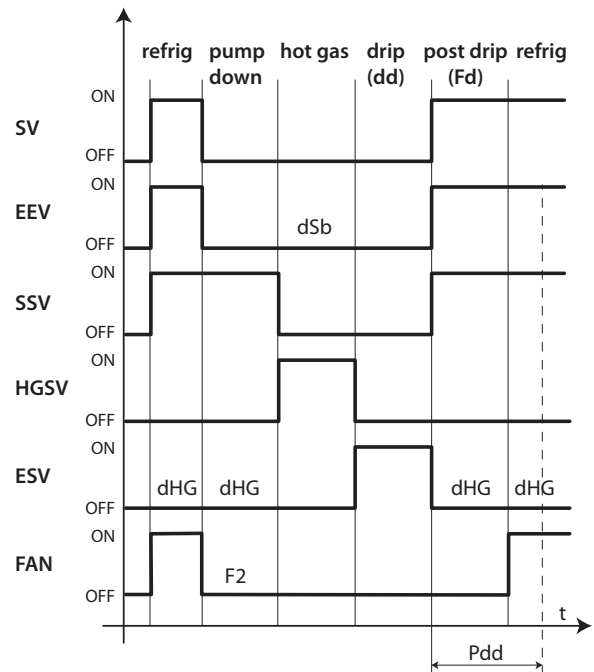

Fig. 5.m

Key

t	Time	SV	Solenoid
FAN	Fan	EEV	Electronic expansion valve
SSV	Suction valve	HGSV	Hot gas valve
ESV	Equalizing valve	Pdd	Valve position maintenance time after defrost
drip	dripping	post drip	post dripping

Example. The following figure shows an installation with an MPXPRO Master controller and an MPXPRO Slave controller, highlighting the hot gas, intake and equalizing valves that are activated in the cycle.

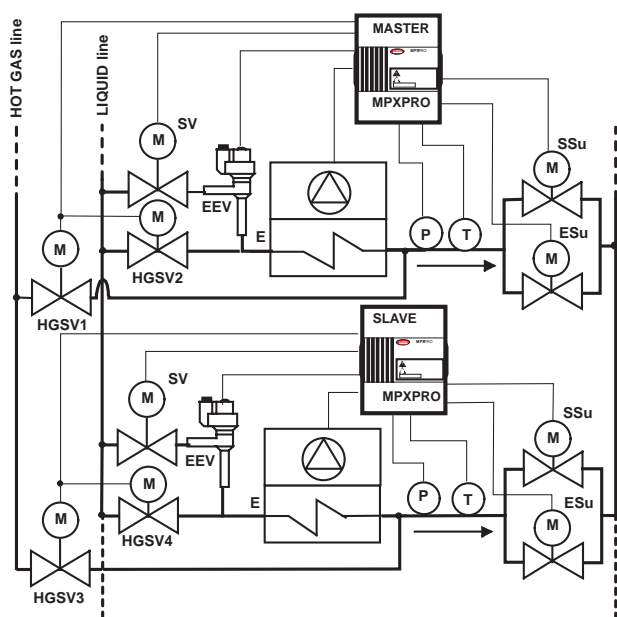

Fig. 5.n

Key

- SSu Suction valve
- EEV Electronic expansion valve
- CMP Compressor
- E Fan-forced evaporator
- SV Solenoid valve
- ESu Equalizing valve
- P Evaporation pressure (PEu)
- HGSV1 to 4 Hot gas valves
- T Superheated gas temp. (tGS)
- SV Solenoid valve



Note:

For hot gas defrosts, in every Master/Slave network:

- depending on parameter dHG the equalizing valve may be closed or open;
- **local defrosts are not possible;**
- the hot gas valve is always and only local (one for each controller);
- the liquid solenoid valve may be local or network;
- the suction and equalizing valve may be local or network;
- the end of a hot gas defrost must be synchronized;
- the change from one phase to the next is always synchronized between all controllers;
- the durations of the various phases are controlled by the parameters set on the Master, the corresponding parameters on the Slaves are not considered.

The defrost starts:

- by setting the event and the start mode, with a maximum of 8 defrosts each day (parameters td1 to td8). The real time clock (RTC) must be available, meaning this is always possible on the Master, which then sends the synchronized requests to the Slaves. If independent programming is required on the Slaves these must also be installed with RTC cards;
- from the supervisor, which sends the defrost call to the Master controller, and this sends it in turn to the Slaves;
- via digital input: for Master Slave networks, a network defrost is activated.

The defrost ends:

- when the defrost probe measures a temperature greater than the end defrost temperature dt1;
- when no defrost probe is used, the defrost ends after a maximum time, set by parameter dP1.



Warnings

If the multiplexed hot gas defrost is set, check any possible consequences of local defrosts performed by individual units that are not synchronized with the remaining units in the multiplexed group.

The installer is responsible for evaluating the effects on the multiplexed system if one of the following events occurs:

- a unit in a multiplexed group performs a local hot gas defrost while the other multiplexed units continue normal control;
- a multiplexed group starts a hot gas defrost while one of the units is offline, and then continues control, or is OFF, if the safety procedure is activated (parameter A13).

In particular, it is recommended to check the settings of the parameters that may cause or allow unsynchronized defrosts between a Master and its Slaves:

- d2: end defrost synchronized by the Master; in general, this parameter should be set to 1 on the Master and the Slaves in the multiplexed group (synchronized end defrost);
- d3: disable network defrost; if set to 1 on a Master unit, this will not propagate the defrost control to the slaves in the local tLAN network; if set to 1 on a Slave unit, this will not start a defrost following reception of the control from its Master;
- d4: maximum interval between consecutive defrosts; this parameter must be set to 0 on all units connected in Master Slave configuration, to prevent unsynchronized defrosts from being performed if the tLAN is offline;
- d5: defrost delay on start-up; this delay must be set in the same way on all the units;
- H6: terminal keypad lock configuration; this should be set to 2 on the Master and the Slaves to avoid starting local defrosts from the keypad.

In addition to setting parameter A13 to 1 (Enable hot gas safety procedure for Slave offline), the safety procedure is also activated, switching a Slave offline if it no longer communicates with its Master.

Maximum interval between consecutive defrosts (parameter dl)

Par.	Description	Def	Min	Max	UoM
dl	Maximum interval between consecutive defrosts	8	0	240	hour

Tab. 5.aa

Parameter dl is a safety parameter used to perform cyclical defrosts every "dl" hours, even without the Real Time Clock (RTC). In case of any scheduled defrosts, the parameter dl should exceed the scheduled timings. It is also useful if the LAN or RS485 serial network is disconnected. At the start of each defrost, irrespective of the duration, an interval starts being counted. If this interval exceeds dl without a defrost being performed, one is started automatically. The count is always active even if the controller is OFF. If set on Master controller, the parameter has effect on all the sub-LANs connected, if set on a Slave controller, it only has an effect locally.

Example: if there is an RTC fault, the defrost programmed by td3 is not performed, and after the safety time dl a new defrost starts.

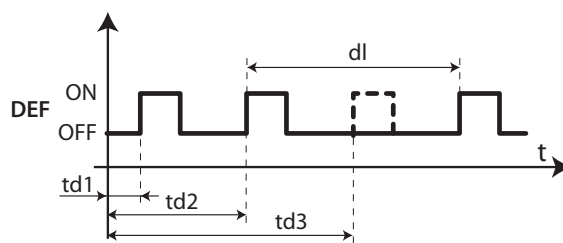

Fig. 5.o

Key

- dl Max. interval between consecutive defrosts
- td1 to td3 Programmed defrosts
- t time
- DEF Defrost

Staggered defrosts

The function is used to perform a series of daily defrosts by setting just the first using parameter td1 and then indicating the number of defrosts per day using parameter d1S. The controller automatically schedules all the defrosts to be performed at regular intervals over the 24 hours following the event defined by td1. The same applies to td2 and dS2.

Par	Description	Def	Min	Max	UoM
d1S	Number of daily defrosts (td1) 0 = Disabled	0	0	14	-
	1 = 24 hours 0 mins				
	2 = 12 hours 0 mins				
	3 = 8 hours 0 mins				
	4 = 6 hours 0 mins				
	5 = 4 hours 48 mins				
	6 = 4 hours 0 mins				
	7 = 3 hours 26 mins				
	8 = 3 hours 0 mins				
	9 = 2 hours 40 mins				
	10 = 2 hours 24 mins				
	11 = 2 hours 11 mins				
	12 = 2 hours 0 mins				
	13 = 1 hour 0 mins				
	14 = 30 mins				
d2S	Number of daily defrosts (td2) see d1S	0	0	14	-

Tab. 5.ab

Remember that sub-parameter "d_" of td1(td2) defines the defrost day, as follows:

d_ = Defrost- day	
0 = event disabled	9 = Monday to Saturday
1 to 7 = Monday to Sunday	10 = Saturday to Sunday
8 = Monday to Friday	11 = every day



Note:

- if event td1 includes a series of days, the programming always ends at 24.00 on the last day. If event td1 includes one day only, the programming ends at 24.00 on the same day;
- if both td1 and td2 are set, when the defrost events overlap, only the sequence of defrost that start first are performed.

5.7 Evaporator fans

The evaporator fans can be managed, if required, according to the temperature measured by the defrost and control probes. The deactivation threshold is equal to the value of parameter F1, and the hysteresis is equal to the value of Frd.



Note: during the dripping waiting time (in the event of network defrosts), and during the dripping time and post-dripping time, if set, the evaporator fans are always off.

Fixed speed fans

Below are the parameters involved in managing fixed speed fans, related by default to relay 4, and an example of the trend based on the difference between the evaporator temperature and the value of the virtual probe (F0=1). If the double thermostat function is enabled, activation is based on the difference between the evaporator temperature and the outlet probe temperature.

If F0=2, activation depends solely on the evaporator probe temperature.

Par.	Description	Def	Min	Max	UoM
F0	Evaporator fan management 0 = always on 1 = activation based on Sd - Sv (or Sd - Sm in double thermostat) 2 = activation based on Sd	0	0	2	-
F1	Evaporator fan activation threshold (only if F0=1 or 2)	-5.0	-50.0	50.0	°C/°F
Frd	Fan activation differential (including variable speed)	2	0.15	20	°C/°F

Tab. 5.ac

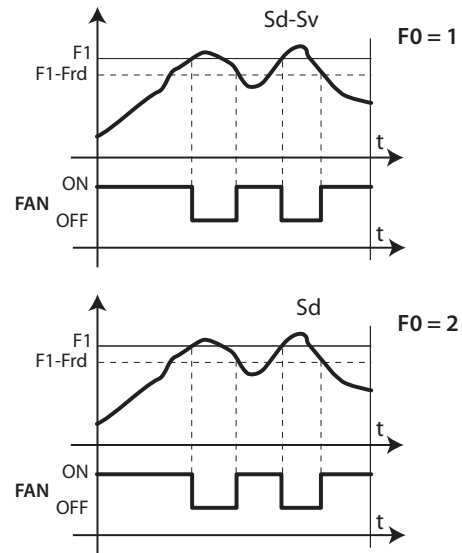

Fig. 5.p

Key

Sd	Evaporator probe	Frd	Differential
Sv	Virtual probe	t	Time
F1	Fan activation threshold	FAN	Evaporator fans

The fan can be turned off in the following situations:

- when the compressor is off (parameter F2);
- during the defrost (parameter F3).

During the dripping period (parameter dd > 0) and the post-dripping period (parameter Fd > 0) the evaporator fans are always off. This is useful to allow the evaporator to return to temperature after defrosting, thus avoiding blowing warm hot and moist air into the refrigerated environment.

The evaporator fans can be forced on during control (parameter F2) and during defrost (parameter F3).

Par.	Description	Def	Min	Max	UoM
F2	Evaporator fans with compressor off 0 = see F0; 1 = always off	1	0	1	-
F3	Evaporator fans during defrost - 0 = on; 1 = off	1	0	1	-
dd	Dripping time after defrost (fans off) 0 = no dripping	2	0	15	min
Fd	Post dripping time after defrost (fans off with control active)	1	0	15	min

Tab. 5.ad

Variable speed fans

The installation of variable speed fans may be useful in optimising energy consumption. In this case, the fans are powered by the mains, while the control signal may come from:

- output PWM1 on the main board;
- a 0 to 10 Vdc output on the driver board.

The maximum and minimum fan speed can be set using advanced parameters F6 and F7.

If using the fan speed controller, F5 represents the temperature below which the fans are activated. There is a fixed hysteresis of 1°C for deactivation.

Par.	Description	Def	Min	Max	UoM
F5	Evaporator fan cut-off temperature (hysteresis 1°C)	50	F1	50	°C/°F

Tab. 5.ae

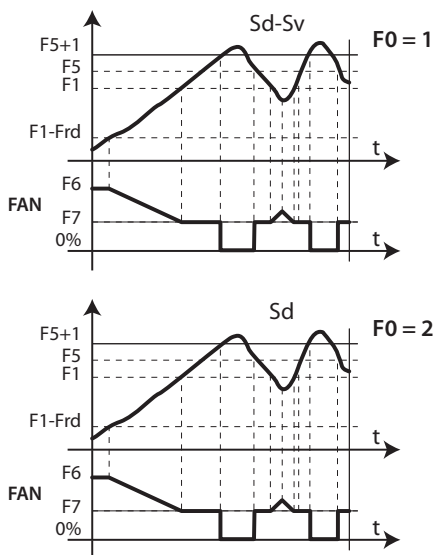

Fig. 5.q

Key

- Sd Evaporator probe
- Sv Virtual probe
- F5 Fan cut-off temperature
- F1 Evaporator activation threshold
- Frd Fan activation differential
- t Time

5.8 Electronic valve

Superheat set point (parameter P3)

Par.	Description	Def	Min	Max	UoM
P3	Superheat set point	10.0	0.0	25.0	K
SH	Superheat	-	-	-	K
tGS	Superheated gas temperature	-	-	-	°C/°F
tEu	Saturated evaporation temperature	-	-	-	°C/°F
PPU	Valve opening percentage	-	-	-	%

Tab. 5.af

The parameter that the control of the electronic valve is based on is the superheat, which effectively tells whether or not there is liquid at the end of the evaporator. The superheat temperature is calculated as the difference between: superheated gas temperature (measured by a temperature sensor located at the end of the evaporator) and the saturated evaporation temperature (calculated based on the reading of a pressure transducer located at the end of the evaporator and using the Tsat(P) conversion curve for each refrigerant)

$$\text{Superheat} = \text{Superheated gas temperature} - \text{Saturated evaporation temperature}$$

If the superheat temperature is high it means that the evaporation process is completed well before the end of the evaporator, and therefore flow-rate of refrigerant through the valve is insufficient. This causes a reduction in cooling efficiency due to the failure to exploit part of the evaporator. The valve must therefore be opened further. Vice-versa, if the superheat temperature is low it means that the evaporation process has not concluded at the end of the evaporator and a certain quantity of liquid will still be present at the inlet to the compressor. The valve must therefore be closed further. The operating range of the superheat temperature is limited at the lower end: if the flow-rate through the valve is excessive the superheat measured will be near 0 K. This indicates the presence of liquid, even if the percentage of this relative to the gas cannot be quantified. There is therefore an undetermined risk to the compressor that must be avoided. Moreover, a high superheat temperature as mentioned corresponds to an insufficient flow-rate of refrigerant. The superheat temperature must therefore always be greater than 0 K and have a minimum stable value allowed by the valve-unit system.

A low superheat temperature in fact corresponds to a situation of probable instability due to the turbulent evaporation process approaching the measurement point of the sensors. The expansion valve must therefore be controlled with extreme precision and a reaction capacity around the superheat set point, which will almost always vary from 3 to 14 K. Set point values outside of this range are quite infrequent and relate to special applications. Parameters SH, tGS, tEu and PPU are display only variables, used to monitor the refrigeration cycle.

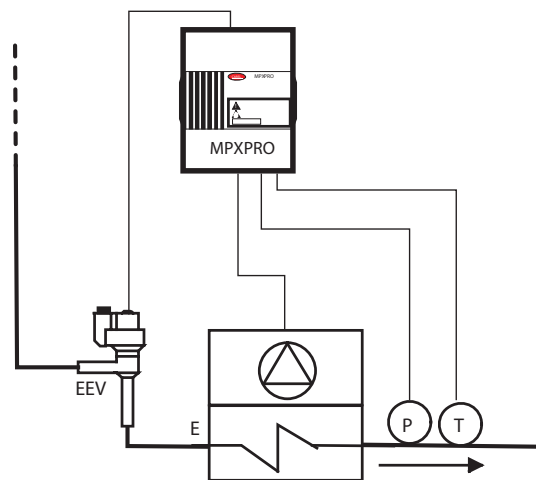

Fig. 5.r

Key

- T Superheated gas temperature
- E Fan-forced evaporator
- EEV Electronic expansion valve
- P Evaporation pressure

LowSH: low superheat threshold (param. P7)

The protector is activated so as to prevent the return of liquid to the compressor due to excessively low superheat values. When the superheat value falls below the threshold, the system enters low superheat status, and the intensity with which the valve is closed is increased: the more the superheat falls below the threshold, the more intensely the valve will close. The LowSH threshold must be less than or equal to the superheat set point. The low superheat integration time indicates the intensity of the action: the lower the value, the more intense the action. See paragraph 6.10.

Par.	Description	Def	Min	Max	UoM
P7	LowSH: low superheat threshold	7.0	-10.0	P3	K

Tab. 5.ag

6. ADVANCED FUNCTIONS

This chapter examines the categories of parameters already described in the chapter on basic functions, so as to explain the use of the corresponding advanced parameters and control algorithms. In addition, the parameters relating to the compressor are explained, all of which are advanced level parameters.

6.1 Probes (analogue inputs)

For an introduction to the probe parameters, see paragraph 5.1. Below is a description of the advanced parameters relating to the probes.

Type of probe, group 1 (parameter /P1)

Set the probes type S1, S2, S3. See the paragraph 5.1.

Par.	Description	Def	Min	Max	UoM
/P1	Type of probe, group 1 (S1...S3)	0	0	3	-

Tab. 6.a

Type of probe, group 2 (parameter /P2)

Set the probes type S4 e S5. See the paragraph 4.3.

Type of probe, group 3 (parameter /P3)

Set the probe type S6. See the paragraph 4.3.

Type of probe, group 4 (parameter /P4)

Set the probe type S7. See the paragraph 5.1.

Par.	Description	Def	Min	Max	UoM
/P4	Type of probe, group 4 (S7)	0	0	6	-

Tab. 6.b

Type of probe, group 5 (parameter /P5)

Par.	Description	Def	Min	Max	UoM
/P5	Type of probe, group 5 : serial probes (S8 to S11)	0	0	15	-

Tab. 6.c

MPXPRO can also manage up to 4 serial probes, which are set directly from the supervisor. These can be defined as temperature probes or generic probes, according to the setting of parameter /P5.

/P5	Probe 8	Probe 9	Probe 10	Probe 11
0	T	T	T	T
1	G	T	T	T
2	T	G	T	T
3	G	G	T	T
4	T	T	G	T
5	G	T	G	T
6	T	G	G	T
7	G	G	G	T
8	T	T	T	G
9	G	T	T	G
10	T	G	T	G
11	G	G	T	G
12	T	T	G	G
13	G	T	G	G
14	T	G	G	G
15	G	G	G	G

Tab. 6.d

Key: T = temperature probe, G = generic probe

Minimum and maximum value probe S6 and S7 (parameters /L6,/U6,/L7,/U7)

MPXPRO, as well as the common NTC, PTC and PT1000 probes, can connect one of the following to inputs S6 and S7:

- one 0 to 5Vdc ratiometric probe (powered directly by the controller), connected to the input S6 or to the input S7;
- one 4 to 20 mA active probe (not powered by the controller), connected to input S7;
- one 0 to 10 Vdc active probe (not powered by the controller), connected to input S7.

These types of probes require definition of their range of measurement, that is, the maximum value and minimum value of measurement are set, using parameters /L6, /L7, /U6 and /U7.

Par.	Description	Def	Min	Max	UoM
/U6	Maximum value of probe 6	9.3	/L6	160 if /5=0 999 if /5=1	barg, RH%
/L6	Minimum value of probe 6	-1	-20 if /5=0 -90 if /5=1	/U6	barg, RH%
/U7	Maximum value of probe 7	9.3	/L7	160 if /5=0 999 if /5=1	barg, RH%
/L7	Minimum value of probe 7	-1.0	-20 if /5=0 -90 if /5=1	/U7	barg, RH%

Tab. 6.e

Assign probe functions (parameters /Fd, /FE, /FF, /FG, /FH, /FI, /FL, /FM, /Fn)

For parameters /Fd and /FE see paragraph 4.3. As well as the outlet Sm, intake Sr and defrost probes Sd, MPXPRO also features:

- defrost probe Sd2, used on the primary or secondary evaporator;
- auxiliary temperature probe 1;
- auxiliary temperature probe 2;
- ambient temperature probe;
- ambient humidity probe;
- glass temperature probe;
- dewpoint serial probe.

The ambient temperature is used by the algorithm to calculate the dewpoint, together with the ambient humidity and glass temperature. The value of the dewpoint can also be sent by the serial probe, for example from the supervisor. See paragraph 6.3.

Par.	Description	Def	Min	Max	UoM
/Fd	Assign superheated gas temperature probe (tGS)	0	0	11	
/FE	Assign saturated evaporation pressure/ temperature (PEu/tEu)	0	0	11	
/FF	Assign defrost temperature probe 2 (Sd2) See /FA	0	0	11	
/FG	Assign auxiliary temperature probe 1 (Saux1) See /FA	0	0	11	
/FH	Assign auxiliary temperature probe 2 (Saux2) See /FA	0	0	11	
/FI	Assign ambient temperature probe (SA) See /FA	0	0	11	
/FL	Assign ambient humidity probe (SU) See /FA	0	0	11	
/FM	Assign glass temperature probe (Svt) See /FA	0	0	11	
/Fn	Assign dewpoint value to serial probe (Sdp) 0 = Func. disabled 1 = Serial probe S8 2 = Serial probe S9 3 = Serial probe S10 4 = Serial probe S11	0	0	4	

Tab. 6.f

 **Note:** in models with built-in driver, the default values are /Fd=4 and /FE=6.

Calibration (parameters /c4,/c5,/c6,/c7,/cE)

Parameters /c4 to /c7 are used to correct the reading made by probes S4 to S7 respectively. Serial probes S8 to S11 do not require calibration. /cE calibrates the saturated evaporation temperature. Calibration is performed before checking if the value is out-of-range, that is, MPXPRO first determines the values read by the probes, correcting them based on the calibration parameters, then checks if these are outside of the range specified and where necessary generates a probe error. Example: To decrease the temperature measured by probe S4 by 3°C, set /c4 = -3.

Par.	Description	Def	Min	Max	UoM
/c4	Probe 4 calibration	0	-20	20	(°C/°F)
/c5	Probe 5 calibration	0	-20	20	(°C/°F)
/c6	Probe 6 calibration	0	-20	20	(°C/°F/barg/ RH%)
/c7	Probe 7 calibration	0	-20	20	(°C/°F/barg/ RH%)
/cE	Saturated evaporation temperature calibration	0.0	-20.0	20.0	°C/°F

Tab. 6.g

6.2 Digital inputs

Configure function of virtual digital input (par. A8)

Par.	Description	Def	Min	Max	UoM
A8	Config. function of virtual digital input 0= input not active 1= immediate external alarm 2= delayed external alarm 3= enable defrost 4= start defrost 5= door switch with compressor and evaporator fans OFF 6= remote ON/OFF 7= curtain switch 8= start/stop continuous cycle	0	0	8	-

Tab. 6.h

As already mentioned, in a Master Slave network, using a virtual digital input, MPXPRO can activate the same digital input on all controllers without needing additional wiring. Likewise, the virtual digital input from the supervisor can also be propagated. Parameter A8 is used to select the function activated on each Slave. If needed, different functions can be configured on the Slaves, meaning a change in status of the contact on the Master activates different functions on the Slaves.

Select digital input propagated from Master to Slaves (par. A9)

This can be configured only on the Master controller, enabling the propagation via tLAN of the status of one of the digital inputs on the Master or sent by the supervisor to the Slaves. Based on the value associated with the parameter, MPXPRO propagates only one of the digital contacts across the LAN, according to the table on the side. The Slaves receive the status of the virtual digital input and activate the corresponding function, according to parameter A8.

Par.	Description	Def	Min	Max	UoM
A9	Select digital input propagated from Master to Slaves (only on Master) 0 = from supervisor 3 = DI3 1 = DI1 4 = DI4 2 = DI2 5 = DI5	0	0	5	-

Tab. 6.i

Example 1:

To propagate the curtain switch function from Master to Slave, activated by digital input 1 on the Master.

Set:

Master	Slave 1, 2, 3, 4, 5
A9=1	A8=7
A8=0	
A4=7	

Example 2:

To propagate the virtual digital input from the supervisor and activate the continuous cycle in the Master Slave network.

Set:

Master	Slave 1, 2, 3, 4, 5
A9=0	A8=8
A8=8	

6.3 Analogue outputs

As mentioned, the most complete version of MPXPRO features 2 PWM outputs, used as the control signal to manage loads such as anti-sweat heaters or modulating evaporator fans, for demisting the display cases.

Anti-sweat heater or fan modulation

The control of anti-sweat heaters is performed by comparing dewpoint calculated based on the ambient temperature and humidity, and the temperature of the display case glass, measured by a probe or estimated using the outlet, intake and ambient temperature of the display case. MPXPRO features two types of anti-sweat heater control:

- PI (proportional, integral);
- fixed activation (manual control).

The conditions for the activation of the algorithms are as follows:

Algorithm	Activation condition
PI	rHd > 0
fixed activation (manual control)	rHd = 0; rHt > 0

Tab. 6.j

If the temperature read by the glass temperature probe is only estimated, PI control becomes proportional only. If both algorithms are activated, the PI algorithm has priority over fixed activation, which does not require the ambient temperature and humidity probes. There are a series of conditions whereby the PI algorithm stops operating and, if activated, MPXPRO - +0300055EN rel. 1.7 - 18.10.2023

fixed activation control takes over. In these cases, if MPXPRO is not OFF, the signal AcE is shown on the display.

Condition	Cause
Glass temperature probe not valid	<ul style="list-style-type: none"> • physical probe not configured or error; • the estimate of the glass temperature probe cannot be used because the outlet probe or intake probe is not configured or has an error or the ambient probe is broken or missing (*)
Dewpoint not valid	<ul style="list-style-type: none"> • humidity probe and/or ambient probe are not configured and operating; • the serial dewpoint value is not available

Tab. 6.k

(*) If the intake probe is not configured or has an error, the outlet probe alone is used.

PI control

Inputs

The humidity (SU) and ambient temperature (SA) probes may be (see parameters /FL, /FI):

- connected to the Master, which automatically shares them with the Slaves;
- connected locally to each controller;
- sent from the supervisor via the serial probes.

Alternatively, the supervisor can directly supply the dewpoint value (Sdp) using the serial probes (see parameter /Fn). The glass temperature probe (Svt) may be connected directly to each controller (see parameter /FM), or estimated. The estimate of the glass temperature probe reading is performed internally when: ambient temperature (SA), outlet temperature (Sm) and intake temperature (Sr) are available, and depends on parameters rHA, rHB and rHS. Parameters rHO, rHD and rHL determine the modulating output.

Par.	Description	Def	Min	Max	UoM
rHA	Coefficient A for glass temperature probe estimate	2	-20	20	°C/°F
rHB	Coefficient B for glass temperature probe estimate	22	0	100	-
rHS	Virtual probe composition for glass temperature probe estimate: 0 = outlet probe Sm; 100 = intake probe Sr	20	0	100	%
rHO	Offset for anti-sweat heater modulation	2.0	-20.0	20.0	°C/°F
rHD	Differential for anti-sweat heater modulation	0.0	0	20.0	°C/°F
rHL	Type of PWM output load for anti-sweat heater modulation: 0 = resistive; 1 = inductive	0	0	1	-

Tab. 6.l

If one of the probes is not available (SA or either Sm or Sr), only fixed activation control will be possible, based on parameters rHu and rHt.

Outputs

Configurable outputs (not relays)	PWM1, PWM2
	0 to 10V

The output used by default is output PWM2 (terminal 19), however this can be changed to other analogue outputs using VPM. The actuator can be selected between anti-sweat heaters or fan with inductive motor using parameter rHL. If the load is resistive (rHL=0), the period is fixed at 24 s and the ON time depends on the PI algorithm. The output is adapted to control an SSR (solid state relay). If the load is inductive (rHL=1) there is no period and the output is modulated continuously by the PI algorithm. In this case, the output is adapted for the MCHRTF phase control modules (see paragraph 2.7). The percentage of activation (OUT) for anti-sweat heater control depends on the difference between the dewpoint calculated and the value read by the glass temperature probe, the value of parameter rHo (offset) and the value of parameter rHd (differential), as shown in the following figure. The CUTOFF is a constant equal to 5 °C and the hysteresis is 1 °C.

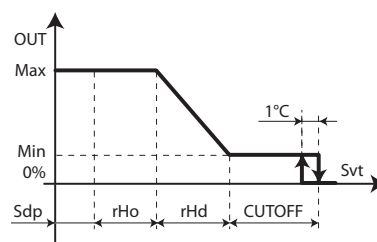

Fig. 6.s

Key

SdP	Dewpoint	Svt	Glass temperature probe
rHo	Offset for anti-sweat heater modulation	Min	Minimum fan speed
rHd	Differential for anti-sweat heater modulation	Max	Maximum fan speed
OUT	Anti-sweat control		

Min: minimum output fixed at 10%; Max: maximum output fixed at 100%. The action is proportional only if the estimate of the glass temperature is used, and proportional and integral (Tint=240 s, constant) if the actual glass temperature probe is used. The aim of the integral action is to bring the glass temperature towards the set point (Sdp+rHo).

! Important: if the serial probes from the supervisor are used for the propagation of the ambient temperature and humidity values, MPXPRO has four auxiliary variables that save the last useful value available for 30 minutes. This may be useful in the event of a supervisor power failure.

Alarms due to probes without updated values are therefore normally shown on start-up, when these variables have not yet been initialised.

Fixed activation control (manual control)

Control depends only on parameters rHu and rHt and follow the trend shown in the figure.

Par.	Description	Def	Min	Max	UoM
rHu	Manual anti-sweat heater activation percentage (of period 'rHt') 0 = function disabled	70	0	100	%
rHt	Manual anti-sweat heater activation period	5	0	180	min

Tab. 6.m

Configurable outputs	PWM1, PWM2
	0 to 10V
	AUX1, AUX2, AUX3

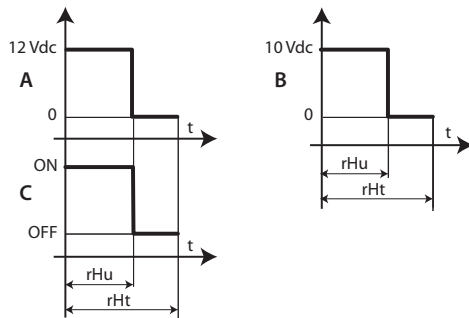

Fig. 6.t

Key:
 A = PWM output B = 0 to 10V dc output C = Relay output
 rHu = Manual anti-sweat heater activation percentage
 rHt = Manual anti-sweat heater activation period t = Time

6.4 Digital outputs

Configure compressor and fan output logic (parameters H10, H11)

Parameters H10 and H11 are used to select the logic of the digital output:
 0: with request active, the N.O. contact closes and N.C contact opens;
 1: with request active, the N.O. contact opens and N.C contact closes.

Par.	Description	Def	Min	Max	UoM
H10	Configure compressor digital output logic 0 = direct logic; 1 = reverse logic	0	0	1	-
H11	Configure evaporator fan digital output logic 0 = direct logic; 1 = reverse logic	0	0	1	-

Tab. 6.n

Compressor output

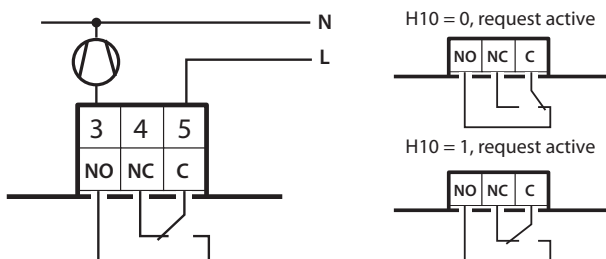

Fan output

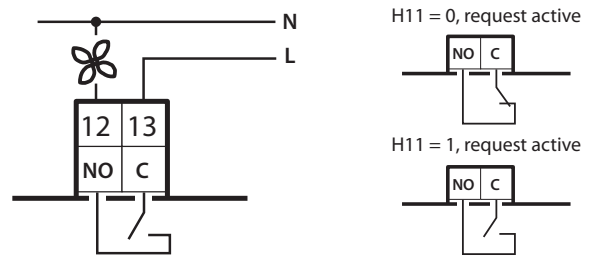

6.5 Control

Minimum and maximum set point values (parameters r1 and r2)

The minimum and maximum value available for the set point can be defined by parameter.

Par.	Description	Def	Min	Max	UoM
r1	Minimum set point	-50	-50	r2	°C/°F
r2	Maximum set point	50	r1	50	°C/°F

Tab. 6.o

ON/OFF (parameter OFF)

The parameter OFF is used to act on the ON/OFF status of the control. A any digital input configured as remote ON/OFF has priority upper respect to the control from the supervisor or to the parameter OFF.

Par.	Description	Def	Min	Max	UoM
OFF	ON/OFF control 0 = ON; 1 = OFF;	0	0	1	-

Tab. 6.p

If more than one digital input is selected as ON/OFF, ON status will be activated when all the digital inputs are closed. The unit is OFF even if just one of the contacts closes. In this operating mode, the display shows the standard display, alternating with the message "OFF". When switching from ON to OFF and vice-versa, the compressor protector times are observed.

When OFF, the following are possible:

- access the F, C, A parameters and the set point;
- select the probe to be displayed;
- activate remote ON/OFF;
- display the probe alarms (rE, E1, E2, E3, etc..) and errors EE, EF, Etc, Edc, alternating with the message OFF.

When OFF, the following alarms are reset:

- high and low temperature;
- open door alarm (dor);
- valve (LSA, LowSH, MOP).

Double thermostat

The double thermostat function is activated by setting parameter rd2>0. It is used to adapt automatically, that is, without changing the set point and without an external signal, control of the unit based on a change in compressor load, especially when switching from day to night and vice-versa. In fact, at night the showcase curtains are closed, there is less heat exchange with the surrounding air and the compressor works less.

To do this, two set points and two differentials are defined:

- St and rd, associated with the outlet probe;
- St2 and rd2, associated with the intake probe.

Par.	Description	Def	Min	Max	UoM
St2	Intake probe set point with "Double thermostat"	50	r1	r2	°C/°F
rd2	Differential St2 with "Double thermostat" 0.0 = function disabled	0	0	20	°C/°F

Tab. 6.q

The control request occurs when this is active on both probes, as if there were two thermostats in series. At night the intake probe is controlled and the outlet probe always signals the request, in the day the outlet probe is controlled and the intake probe always signals the request.

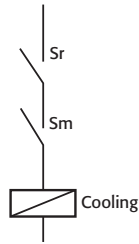

Fig. 6.u

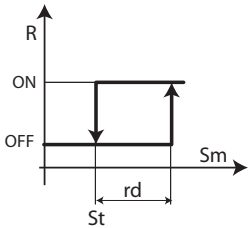

Fig. 6.v

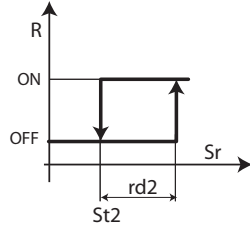

Fig. 6.w

Key

Sm = outlet probe
Sr = intake probe
R = control request

rd = differential for St
rd2 = differential for St2

Below is an example of the temperature trend on a vertical showcase during the day and at night.

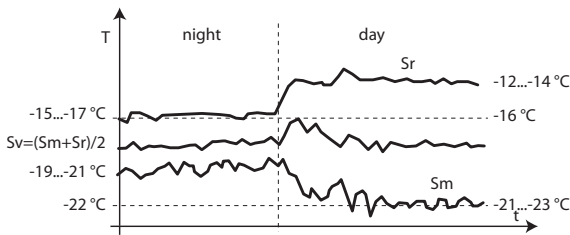

Fig. 6.x

Key:

Sm Outlet probe
Sr Intake probe
T Temperature

Sv Virtual probe
t time

NIGHT: Sm = -19...-21 °C - Set point = -22 °C

DAY: Sm = -21...-23 °C - Set point = -22 °C

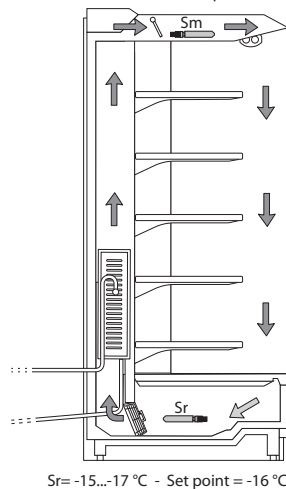

Fig. 6.y

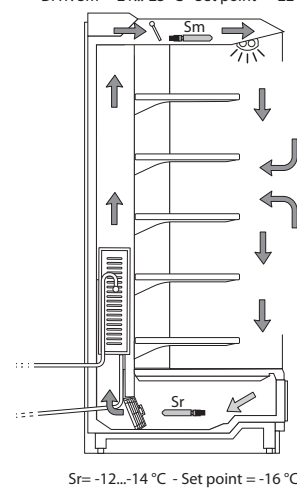

Fig. 6.z

Key:

Sm Outlet probe
Sr Intake probe



Note:

- if one of the probes has an error or is missing, it is considered as signalling the request;
- if both probes are faulty or missing, the controller switches to Duty setting mode: see paragraph 6.6.



Important: if the double thermostat function is activated, the setting of the following parameters has no effect:

- r6 (probe for night-time control);
- r4 (automatic night-time set point variation).

Control offset with probe error (parameter ro)

Par.	Description	Def	Min	Max	UoM
ro	Control offset with probe error	0.0	0.0	20	°C/°F

Tab. 6.r

MPXPRO in standard mode uses the virtual probe Sv for control, that is, the weighted average of the outlet and intake probe (see parameter /4). If one of the two probes making up the virtual probe is broken or has an error, parameter ro is used to continue normal control in controlled conditions, without the need for immediate intervention by maintenance personnel. The recommended value of ro is the temperature difference between the outlet probe and intake probe reading in steady operating conditions of the refrigeration unit:

$$ro = Sr - Sm$$

If ro=0 the function is not active. The following cases may occur:

- outlet probe Sm error: MPXPRO starts control based on the intake probe Sr alone, considering a new set point (St*) determined by the formula:

$$St^* = St + ro \cdot \frac{(100 - /4)}{100}$$

- intake probe Sr error: MPXPRO starts control based on the outlet probe Sm alone, considering a new set point (St*) determined by the formula:

$$St^* = St - ro \cdot \frac{/4}{100}$$

If night-time operation has been set with the intake probe as the control probe, the controller considers /4=100 and uses the outlet probe. The new set point becomes:

$$St^* = St - ro$$



Note:

- if ro=0 the function is not active;
- for night-time operation the new set point is added to the value defined by r4 (= automatic night-time set point variation);
- in the event of errors on both probes, the controller switches to duty setting operation, see paragraph 6.6.

Example: Sm fault in daytime operation, with /4=50, St=-4, Sr=0, Sm=-8, ro (recommended) = 0-(-8)=8. The new control probe will be Sr with:

$$St^* = St + ro \cdot \frac{(100 - /4)}{100}$$

Therefore St* = -4 + 8 · (100-50)/100 = 0

If the fault is on Sr, the new control probe will be Sm with:

$$St^* = St - ro \cdot \frac{/4}{100}$$

Therefore St* = -4 - 8 · 50/100 = -8.

ON time for duty setting operation(parameter c4)

Duty setting is a special function used to maintain control in emergency situations with errors in the temperature control probes, until the service intervention. In the event of a temperature probe error, MPXPRO uses the other probe available and adjusts the set point according to the setting of parameter ro. In the event of errors on both probes, MPXPRO switches to Duty setting mode. The controller is activated at regular intervals, operating for a time equal to the value set for the duty setting parameter c4, and off for a fixed time of 15 minutes.

Par.	Description	Def	Min	Max	UoM
c4	ON time for duty setting operation (Toff = 15 minutes fixed) 0 = compressor/valve always OFF; 100 = compressor/valve always ON	0	0	100	min

Tab. 6.s

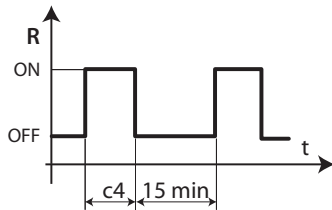

Fig. 6.aa

Key:

R Control
c4 ON time

With Duty setting active, during the ON time the compressor icon remains on, while it flashes during the OFF time.

Important: during duty setting, the compressor protection times are not observed.

The table below describes the possible fault situations relating to the control probes and the function that is activated.

Type of system	Control probe fault		Control	Parameter
	Sm	Sr		
1 probe	●		Duty setting	c4
		●	Duty setting control on Sr	c4 ro(*)
2 probes	●	●	control on Sm	ro(*)
	●	●	Duty setting	c4

Tab. 6.t

* ro must be >0.

Duty setting with shared control status

For the description of shared control status, see paragraph 5.1. The activation of the duty setting mode on the Master controller implies that all the related Slaves observe the Master controller compressor management times. This operating mode is highlighted on the Master user interface by the compressor icon on steady; the Slave controllers ignore the Master control mode and do not show the compressor icon flashing when the compressor is off. If a Slave activates duty setting mode due to lack of communication with the Master, the Slave manages the display on the user interface as normal.

Continuous cycle (parameter cc)

Continuous cycle is a function used to keep the refrigeration cycle active continuously for a settable duration, irrespective of the temperature inside the unit. This may be useful when requiring a rapid decrease in the temperature, even below the set point. The activation of the low temperature alarm when exceeding the threshold AL or AL2 can be delayed by setting parameter c6.

Par.	Description	Def	Min	Max	UoM
cc	Running time in continuous cycle 0 = disabled	1	0	15	hour
c6	Low temperature alarm bypass time after continuous cycle	60	0	240	min

Tab. 6.u

The continuous cycle is activated by pressing UP and DOWN for more than 5 s, from the supervisor or via digital input.

When the continuous cycle is running:

- the icon is displayed;
- the compressor/solenoid valve output and electronic valve control are activated and the corresponding icon is shown on the display;
- the low temperature alarm with threshold AL is enabled relating to the probe defined by parameter AA as well as the low temperature alarm with threshold AL2 relating to the probe defined by parameter AA2.

Important: for the correct activation of the low temperature alarms, set the parameters as follows:

- AA = outlet probe;
- AA2 = intake probe.

Note:

1. The continuous cycle cannot be activated if:
 - the duration of the continuous cycle is set to 0 (cc=0);
 - the measurements of the probes defined by AA and AA2 have exceeded their respective thresholds AL, AL2.
 - the device is OFF.
2. The continuous cycle remains in standby if:
 - the compressor protection times are set (c1, c2, c3);
 - the immediate or delayed alarm from external digital input delays the activation of the compressor;
 - defrost, dripping, post-dripping are running;
 - the door is open. When door opens the continuous cycle is stopped. It restarts for the remaining time when the door is closed.
3. The continuous cycle ends:
 - by pressing of UP & DOWN for more than 5 seconds;
 - when reaching the low temperature threshold (AL or AL2 in double thermostat), whichever is reached first;
 - at the end of the time cc;
 - when the controller is switched off from the supervisor (logical OFF);
 - from the supervisor.

Continuous cycle with shared control status

For the description of shared control status, see paragraph 5.1. The activation of the continuous cycle on the Master controller implies that all the related Slaves observe the Master controller compressor management times (only parameter 'cc' on the Master has effect, while the setting on the Slaves is ignored). This operating mode is highlighted on the Master user interface by the corresponding icon on steady; the Slave controllers ignore the Master control mode and manage the display as normal (compressor icon on during the cooling request and off when there is no request).

Defrost priority over continuous cycle

Par.	Description	Def	Min	Max	UoM
c7	Defrost priority over continuous cycle 0 = no; 1 = yes	0	0	1	-

Tab. 6.v

If c7=0 the defrost and continuous cycle are not mutually interruptible (same priority): any defrost or continuous cycle request remains pending if activated when running the other procedure. If c7=1 the defrost calls activated when the continuous cycle is running terminate the latter and activate the defrost.

Delay in closing suction valve during normal control

Par.	Descrizione	Def	Min	Max	UoM
rSU	delay in closing suction valve during normal control 0 = always open	0	0	999	sec

Tab. 6.w

If using suction valve for hot gas defrosts, the suction valve can also be managed during normal control. If rSu is not 0, during normal refrigeration control the suction valve will be closed rSu seconds after the optional solenoid valve is closed. This allows the compressors to empty the evaporator before completely closing the circuit.

6.6 Compressor

MPXPRO features the following compressor protection parameters.

Par.	Description	Def	Min	Max	UoM
c0	Delay enable compressor and evaporator fans on power-up	0	0	240	min
c1	Minimum time between successive starts	0	0	15	min
c2	Minimum OFF time	0	0	15	min
c3	Minimum ON time	0	0	15	min
d9	Defrost priority over compressor protection times 0 = protection times observed; 1 = protection times not observed	1	0	1	-

Tab. 6.x

- c0 is used to delay the start of control when the device is powered up. This is useful in the event of power failures, so that the controllers (in the network) don't all start at the same time, avoiding potential problems of electrical overload. In models with Carel electronic expansion valve and ultracap technology, this parameter must be set to a value greater than 2.
- c1 sets the minimum time between two successive starts of the compressor, irrespective of the request. This parameter can be used to limit the maximum number of starts per hour;
- c2 sets the minimum compressor off time. The compressor is not started again until the minimum time set has elapsed;
- c3 sets the minimum compressor running time;
- d9 disables the compressor protection times when defrosting, useful for hot gas defrosts:
 - d9 = 0: the protection times are observed;
 - d9 = 1: the protection times are not observed, the defrost has higher priority.

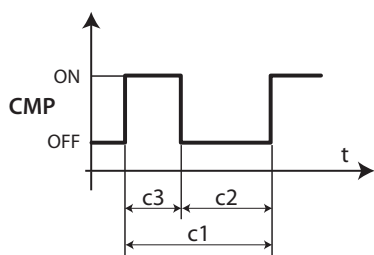

Fig. 6.ab

Key:

t time

CMP compressor

6.7 Defrost

The advanced parameters for defrost management include general parameters on the time base, activation delays, synchronization between Master and Slaves, the stages of the defrost such as pump down and dripping, and the advanced defrost functions, such as:

- Skip defrost; Running time; Sequential stops; Power defrost.

End defrost synchronized by Master (parameter d2)

Par.	Description	Def	Min	Max	UoM
d2	End defrost synchronized by Master 0 = not synchronized; 1 = synchronized	1	0	1	-

Tab. 6.y

The parameter determines whether or not, in a local network, MPXPRO awaits an end defrost signal from the Master at the end of the defrost.

End defrost signal by timeout (parameter r3)

Par.	Description	Def	Min	Max	UoM
r3	End defrost signal by timeout 0 = disabled, 1 = enabled	0	0	1	-

Tab. 6.z

For defrosts that end by temperature (d0=0, 1, 5), this enables the end defrost by timeout signals Ed1 and Ed2.

Defrost on power-up (parameter d4)

Par.	Description	Def	Min	Max	UoM
d4	Defrost on power-up 0= disabled ; 1 = enabled (Master = network defrost; Slave = local defrost)	0	0	1	-

Tab. 6.aa

The defrost call on power-up has priority over the control request and the activation of the continuous cycle. For Master controllers, the defrost on power-up will be a network defrost; for Slave controllers it will be local.

Defrost delay on power-up (parameter d5)

Par.	Description	Def	Min	Max	UoM
d5	Defrost delay on power-up or (for Slave) after control from Master 0 = delay disabled	0	0	240	min

Tab. 6.ab

Also active when d4=0. If the digital input is set to enable or start a defrost from an external contact, parameter d5 represents the delay between when the defrost is enabled or called, and when it effectively starts.

d5 delay also takes place in situations below:

- after interval between defrosts 'dl' elapsed;
- RTC timer elapsed;
- Interval between defrosts 'dl' elapsed with skip defrost algorithm.

For Mater/Slave networks where the defrost needs to be activated from a digital input on the Master, use parameter d5 to delay the various defrosts, thus avoiding current overloads.



Note: to avoid unwanted defrosts controlled by the controller timer, set parameter dl=0 (defrosts from keypad, RTC, compressor running time or digital input only).

Time base for defrost (parameter dC)

Par.	Description	Def	Min	Max	UoM
dC	Time base for defrost 0=dl in hours, dP1, dP2 and ddP in minutes; 1= dl in minutes, dP1, dP2 and ddP in seconds	0	0	1	-

Tab. 6.ac

This defines the unit of measure used to count the times for parameters dl (defrost interval), dP1, dP2 and ddP (defrost duration):

- dC=0 =>dl expressed in hours, dP1, dP2 and ddP in minutes;
- dC=1 =>dl expressed in minutes, dP1, dP2 and ddP in seconds.



Note: parameter dC=1 can be useful for quickly testing the defrost operation with reduced times. It is also useful for controlling the operation of air dryers. The defrost cycle thus becomes the condensate discharge cycle, which needs to be started at short intervals (minutes) and for very brief periods (seconds).

Dripping time after defrost (parameter dd)

Par.	Description	Def	Min	Max	UoM
dd	Dripping time after defrost (fans off) 0 = no dripping	2	0	15	min

Tab. 6.ad

This parameter is used to stop the compressor and the evaporator fans following a defrost so as to allow the evaporator to drip. The value of the parameter indicates the off time in minutes. If dd=0 no dripping time is enabled, and at the end of the defrost control resumes immediately, without stopping the compressor and the fan, if active.

Valve positioning during defrost (parameter dSb)

A fixed position (as a percentage) can be set for valve opening throughout the defrost procedure, from the end of pump-down to the start of the dripping stage. The valve will behave as defined by parameters cP1 and Pdd starting from the post-dripping stage. The opening percentage is applied in all the types of defrost. The function is activated by setting parameter dSb to a value between 1 and 100; this value indicates the position of the valve.

Setting the parameter to 1, the valve is closed completely during defrost. Setting the parameter to 0, positioning is disabled and the valve will behave as defined for the type of defrost selected.

Par.	Description	Def	Min	Max	UoM
d5b	Valve position during defrost. 0 = valve positioned as defined for the type of defrost selected 1 = valve forced closed 2 - 100 = opening percentage	0	0	100	%

Tab. 6.a

Pump down phase duration

Par.	Description	Def	Min	Max	UoM
dH1	Pump down phase duration 0 = pump down disabled	0	0	999	s

Tab. 6.ae

The pump down phase is the period in which the evaporator is emptied of liquid refrigerant. Parameter dH1 defines the duration of the pump down phase during all types of defrost, heater or hot gas. Setting dH1=0 disables the pump down phase.

Important: the controller does not have two separate outputs to manage the compressor and solenoid valve.

Type of multiplexed hot gas defrost

Par.	Description	Def	Min	Max	UoM
dHG	Type of hot gas defrost 0 = equalizing valve normally closed 1 = equalizing valve normally open	0	0	1	-

Tab. 6.af

See paragraph 5.6 for an installation diagram with equalizing valve. Located in parallel with the suction valve, it can be open only in the dripping phase or also during the normal refrigeration cycle, the pump down and post-dripping phases.

Defrost Running time (parameters d10, d11)

Running time is a special function that determines when the refrigeration unit needs defrosting. In particular, it is assumed that if the evaporator temperature measured by probe Sd remains continuously below a certain set threshold (d11) for a certain time (d10), the evaporator may be frozen and a defrost is activated. The time is reset if the temperature returns above the threshold.

Par.	Description	Def	Min	Max	UoM
d10	Defrost time in "Running time" mode 0 = function disabled	0	0	240	min
d11	Defrost temperature threshold in "Running time" mode	-30	-50	50	°C/°F
dt1	End defrost temperature (read by Sd)	8	-50.0	50.0	°C/°F
dt2	End defrost temperature (read by Sd2)	8	-50.0	50.0	°C/°F

Tab. 6.ag

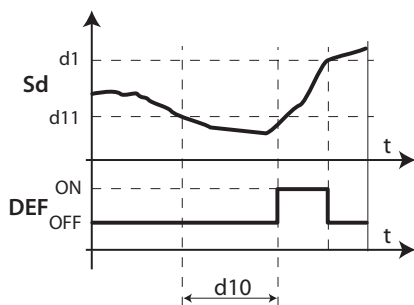

Fig. 6.ac

Key
Sd Defrost probe t Time
DEF Defrost

Important: for multiplexed hot gas defrosts, the setting is only valid on the Master and the defrost is synchronized across the Master/Slave network.

Pressure probe alarm management during defrost (parameter d12)

During defrost and dripping, so as to avoid false pressure probe error signals, errors are ignored. The supervisor update can also be disabled.

Par.	Description	Def	Min	Max	UoM		
d12	Pressure probe alarm management during defrost	0	0	3	-		
	probe error					supervisor update	
	0					disabled	enabled
	1					enabled	enabled
	2					disabled	disabled
3	enabled	disabled					

Tab. 6.ah

Sequential stops (parameters dS1, dS2)

Par.	Description	Def	Min	Max	UoM
dS1	Compressor off time in "Sequential stop" defrost mode	0	0	45	min
dS2	Compressor operating time in "Sequential stop" defrost mode	120	0	240	min

Tab. 6.ai

Sequential stop mode is especially useful for high-normal temperature refrigeration controllers, and is based on the intelligent stopping of control to allow the evaporator to defrost naturally by the flow of ambient air only, without activating the defrost output and consequently the defrost heaters. If the function is enabled (parameter dS1>0), two counters are activated:

- OFFTIME: counts down during the stop time and on hold during control;
- ONTIME: counts down during control and on hold during the stop time.

Two events may occur, with reference to the following figure:

1. OFFTIME is reset (instant C): OFFTIME and ONTIME are reset with dS1 and dS2 value and the defrost is considered completed. Control resumes;
2. ONTIME is reset (instant A): OFFTIME is reset with the default value and the natural defrost starts, lasting the time dS1. At the end of the defrost (instant B), OFFTIME and ONTIME are reloaded with dS1 and dS2 value and control resumes;

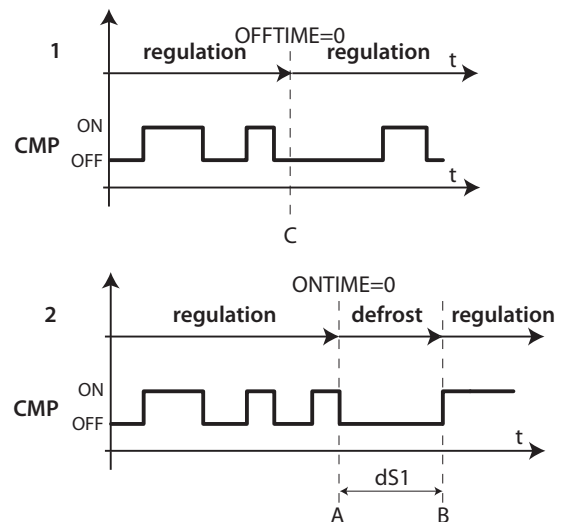

Fig. 6.ad

Key
CMP Compressor t Time

The purpose is to stop control and allow natural defrosts only when necessary.

When control stops in sequential stop mode, the defrost icon will come on, the defrost status will be sent to the supervisor and the display will reflect the setting of parameter d6.

Note: the setting of parameter F3 has no effect. Evaporator fan management depends on parameter F0.

Skip defrost (parameters d7, dn)

The function applies to defrosts that end by temperature, otherwise it has no effect. The Skip defrost function evaluates whether the defrost duration is less than a certain threshold dn1 (dn2) and based on this establishes whether or not the following defrosts will be skipped.

Par.	Description	Def	Min	Max	UoM
d7	Skip defrost: 0 = disabled; 1 = enabled;	0	0	1	-
dn	Nominal defrost duration for "Skip defrost"	75	0	100	%
dP1	Maximum defrost duration	45	1	240	min
dP2	Maximum secondary evaporator defrost duration	45	1	240	min

Tab. 6.aj

Thresholds dn1 (evaporator 1) and dn2 (evaporator 2) are defined by:

$$dn1 = \frac{dn}{100} \cdot dP1, \quad dn2 = \frac{dn}{100} \cdot dP2$$

The algorithm keeps a counter of the defrosts to be skipped:

- if the defrost ends in a time less than dn1, the counter of the defrosts to be skipped is increased by 1;
- if the defrost ends normally, the next defrost is performed;
- when the counter reaches , 3, three defrosts are skipped and then the counter is reset to 1;
- on power-up, the defrost is performed 7 times without increasing the counter, from the eighth on the counter is updated.

Note: in power defrost mode (see the following paragraphs), the maximum defrost duration dP1 and dP2 is increased by the value of parameter ddP.

Power defrost (parameters ddt, ddP)

Power defrost is used to increase the end defrost threshold dt1 (dt2 for the second evaporator) and/or the maximum defrost duration dP1 (dP2 for the second evaporator). These increases allow longer and more effective defrosts. Power defrost are performed on each defrost call during night status or when suitably configured by the RTC parameters (sub-parameter P of parameters td1 to td8), so as to allow the user to choose the conditions that are most suitable for this special procedure. Power Defrost is activated when at least one of the increases, ddt or ddP, has any value other than zero.

Par.	Description	Def	Min	Max	UoM
ddt	Additional end defrost temperature delta for Power defrost mode	0.0	-20.0	20.0	°C/°F
ddP	Additional maximum defrost time delta for Power defrost mode	0	0	60	min
P__	Defrost 1 to 8 – enable Power defrost: 0 = normal; 1 = Power defrost	0	0	1	-

Tab. 6.ak

6.8 Evaporator fans

See paragraph 5.7. The advanced parameters for the evaporator fans concern the minimum and speed maximum, the selection of the type of motor (inductive or capacitive) and the setting of the start-up time.

Par.	Description	Def	Min	Max	UoM
F6	Maximum fan speed	100	F7	100	%
F7	Minimum fan speed	0	0	F6	%
F8	Fan peak time 0 = function disabled	0	0	240	s
F9	Select fan control with output PWM1/2 (with phase cutting speed control) 0 = by pulse; 1 = by duration	1	0	1	-
F10	Evaporator fan forcing time at maximum speed: 0 = function disabled	0	0	240	min

Tab. 6.al

F6: is the maximum fan speed, expressed as a % of the output. For 0 to 10 V outputs, it represents the output voltage at maximum speed as a percentage. For phase control outputs, it represents the maximum portion of the semi-wave applied to the load as a percentage. The same is true for the minimum speed set for F7. The fan peak time F8 represents the operating time at maximum speed set using parameter F6 to overcome the mechanical inertia of the motor. F10 represents the time the fan is operated at maximum speed for the peak time (F8).

If the fan is operated for too long at a reduced speed, ice can form on the blades. To avoid this, at intervals of F10 minutes, the fan is forced to the maximum speed for the time expressed by the parameter F8. If the evaporator fan speed is controlled with phase control, F9 determines the type of control:

F9=0: by pulse, for capacitive motors;

F9=1: by duration, for inductive motors.

See paragraph 5.7 for the meaning of parameters F5, F1, Frd.

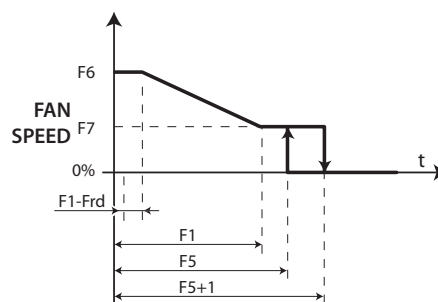

Fig. 6.ae

6.9 Electronic valve

The stepper electronic valve requires a power supply to be able to open or close. Starting from version 2.8, MPXPRO features a special ultracap to guarantee the power required to close the electronic valve in the event of power failures. Further details on installing and selecting the cable are shown in the section on connections and wiring diagrams. The ultracap takes around 2 minutes to charge completely when completely discharged. It is therefore recommended to set a delay time no less than 2 minutes for compressor and evaporator fans enabling in power-up (parameter c0).

Introduction

MPXPRO, depending on the optional cards installed, can manage different types of electronic expansion valve. Specifically:

Driver	Code	Model of valve
stepper	MX30PSTP*	CAREL E ² V
PWM	MX30PPWM**	PWM 115 to 230 Vac PWM 110 to 230 Vdc

Tab. 6.am

To manage the electronic expansion valve, two additional probes must be installed and suitably configured:

- temperature probe for measuring the superheated gas temperature at the evaporator outlet.
- pressure probe for the measurement of the saturated evaporation pressure / temperature at the evaporator outlet.

Installation notes: MPXPRO is designed to manage one electronic expansion valve that controls the flow of refrigerant inside an individual evaporator. Two evaporators in parallel cannot be managed with just one electronic expansion valve.

- The NTC/PTC/PT1000/NTCL243 temperature probe must be installed near the evaporator outlet, according to the standard installation methods (see the installation notes on the E²V instruction sheet). Suitable thermal insulation is recommended. CAREL offers special types of probes designed to simplify installation in contact with the refrigerant pipe:
 - NTC030HF01 for Retail use IP67, 3m, -50T90 °C, 10 pcs
 - NTC060HF01 for Retail use IP67, 6m, -50T90 °C, 10 pcs

To measure the saturated evaporation temperature, different types of probes can be used; in particular, the following can be configured (advanced parameter /FE):

- 0 to 5 V ratiometric pressure probe (recommended by CAREL);
- NTC/PTC/PT1000 temperature probe;
- 4 to 20 mA active pressure probes (powered externally).

MPXPRO can measure the saturated evaporation temperature using a normal NTC/PTC/PT1000/NTCL243 temperature probe (see price list). This solution, even if economically convenient, requires careful installation and in any case does not offer the same precision as a ratiometric probe. CAREL recommends the use of ratiometric probes for reading the

evaporation pressure, which is automatically converted to the saturated temperature using the specific tables for the type of refrigerant used.

Description of operation

The values read by the probes described above are called:

- tGS = superheated gas temperature;
 - tEu = saturated evaporation temperature converted from pressure
- These values are used to calculate the superheat:
- SH = tGS - tEu

MPXPRO manages the proportional opening of the electronic expansion valve, adjusting the flow of refrigerant in the evaporator, so as to maintain the superheat around the value set for advanced parameter P3 (superheat set point). The opening of the valve is controlled simultaneously yet independently from normal temperature control. When there is a refrigeration call (the compressor / solenoid valve relay is activated), control of the electronic valve is also activated and then managed independently. If the superheat value read by the probes is greater than the set point, the valve is opened proportionally to the difference between the values. The speed of variation and the percentage of opening depend on the PID parameters set. The opening is continuously modulated based on the superheat value, with PID control.

Note: all the references relating to control of the electronic valve are based on the use of a CAREL E²V electronic expansion valve. The descriptions are then made considering the steps of the stepper motor used for this type of valve, for example, the maximum number of opening steps is 480. All the functions are also then described for PWM valves. In particular, instead of the maximum opening expressed as the number of steps, the maximum ON/OFF time of the PWM valve is considered (default 6 seconds). The absolute openings expressed as steps must then be suitably converted by the user and referred to the maximum fixed period, expressed in seconds.

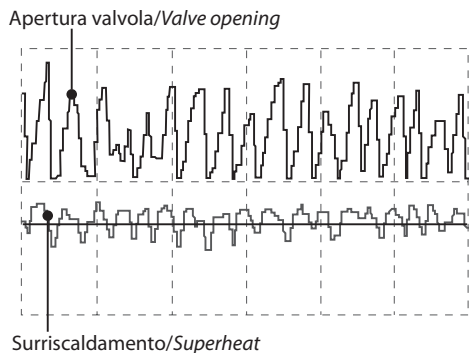

Fig. 6.af

Type of refrigerant (parameter PH)

This is used to set the type of gas refrigerant used in the system. The table below shows the types of gas possible and the associated PH values. For compatibility with the E²V valve see paragraph 4.3. Contact CAREL if installing E²V valves in systems that use refrigerants not listed in the table.

Par.	Description	Def	Min	Max	UoM
PH	Type of refrigerant	3	0	40	-
	0 = Gas custom				
	1 = R22,				
	2 = R134a,				
	3 = R404A,				
	4 = R407C,				
	5 = R410A,				
	6 = R507A,				
	7 = R290,				
	8 = R600				
	9 = R600a				
	10 = R717,				
	11 = R744,				
	12 = R728,				
	13 = R1270,				
	14 = R417A,				
	15 = R422D,				
	16 = R413A,				
	17 = R422A,				
	18 = R423A,				
	19 = R407A,				
	20 = R427A,				
	21 = R245FA,				
	22 = R407F,				
	23 = R32,				
	24 = HTR01,				
	25 = HTR02,				
	26 = R23,				
	27 = R1234yf,				
	28 = R1234ze,				
	29 = R455A,				
	30 = R170,				
	31 = R442A,				
	32 = R447A,				
	33 = R448A,				
	34 = R449A,				
	35 = R450A,				
	36 = R452A,				
	37 = R508B,				
	38 = R452B,				
	39 = R513A,				
	40 = R454B				

Tab. 6.an

Important: if the type of refrigerant is not correct, there may be return of liquid to the compressor.

In addition, a temperature/pressure conversion curve corresponding to an arbitrary new refrigerant can be entered (custom gas) by writing from

the supervisor suitable coefficients, a numeric ID for the gas and the CRC protection value. The coefficients are provided by Carel.

Once the new refrigerant has been entered, it will be available by setting parameter PH to 0. The value 0 can only be applied if the cyclic redundancy check (CRC) does not detect errors.

If the coefficients are modified after having chosen to use a custom refrigerant (PH = 0) and the CRC check fails, the GPE alarm will be displayed on the user interface and control will stop.

Electronic valve (parameter P1)

MPXPRO can control two different models of electronic expansion valve, each with the specific type of optional expansion board. Parameter P1 is used to set the model installed:

Par.	Description	Def	Min	Max	UoM
P1	0 = not used, 1 = PWM valve 2 = CAREL E ² V valve 3 = 0-10V modulation for refrigerant control 4 = PWM valve (on driver board) for refig. control 5 = modulation of E2V Carel valve driver stepper motor for refrigerant control	0	0	5	-

Tab. 6.ao

Superheat set point (parameter P3)

This is used to set the reference superheat value for the control of the electronic valve. It does not determine the actual superheat value, but rather the desired value. MPXPRO, with PID control, tends to maintain the actual superheat, calculated based on the probe readings, around the value set for this parameter. This is done by gradually varying the opening of the valve based on the difference between the actual superheat and the set point.

Important: the set point value calculated depends on the quality of the installation, the position of the probes and other factors. Consequently, depending on the installation the set point read may deviate from the actual value. Set point values that are too low (2 to 4 K), albeit ideally usable, may cause problems involving the return of liquid refrigerant to the compressor rack.

Par.	Description	Def	Min	Max	UoM
P3	Superheat set point	10.0	0.0	25.0	K

Tab. 6.ap

Initial valve position when control starts (par. cP1)

This is used to set the position of the valve as a percentage when control starts. High values ensure intense and immediate cooling of the evaporator when each call is sent, however may cause problems if the valve is oversized with reference to the cooling capacity of the controller. Low values, on the other hand, allow a more gradual and slower action.

Par.	Description	Def	Min	Max	UoM
cP1	Initial valve position when control starts	30	0	100	%

Tab. 6.aq

Initial valve position maintenance time after defrost (parameter Pdd)

At the end of a defrost, during the dripping phase, the expansion valve can be forced open to the initial value set for cP1 for a time equal to Pdd. This means greater immunity of the unit to return of liquid to the compressor rack due to an excessively high evaporator temperature.

Par.	Description	Def	Min	Max	UoM
Pdd	Initial valve position maintenance time after defrost	10	0	30	min

Tab. 6.ar

Valve standby position (parameter PSb)

This indicates the position, as the absolute number of steps, that the valve must move to after having completely closed, to restore the elastic operating conditions of the valve spring, by releasing the compression (for stepper valve only).

Note: the value of this parameter represents the absolute position of the valve during the closing phase (value read using the advanced parameter PF on the supervisor).

Par.	Description	Def	Min	Max	UoM
PSb	Valve standby position	0	0	400	step

Tab. 6.as

Enable fast update of the valve parameters to supervisor (parameter Phr)

This is used to enable the fast update to the supervisor of the variables relating to the electronic expansion valve, such as:

- PF: absolute position in number of steps (stepper valve only);
- SH: superheat;
- PPV: position as a percentage;
- tGS: superheated gas temperature;
- tEu: saturated evaporation temperature;

Useful in the commissioning phase or start-up:

Phr = 0: fast update disabled (update every 30 s);

Phr = 1: fast update enabled (update every 1 s).

Par.	Description	Def	Min	Max	UoM
Phr	Enable fast update of the valve parameters to supervisor: 0 = fast update disabled	0	0	1	-

Tab. 6.at

Important: in the event of power failures, parameter Phr will be reset to zero.

Superheat offset for modulating thermostat (parameter OSH)

This function is used to reduce or completely eliminate the typical temperature swings caused by sudden activation/deactivation of the solenoid valve. The function is activated based on the refrigeration controller control temperature and affects the cooling capacity of the electronic valve. In particular, the function is activated when the control temperature falls below half of the differential rd. In this band, the superheat set point P3 is increased by a term proportional to the parameter OSH. The effect of this action is the gradual advanced closing of the electronic valve, which makes the decrease in temperature inside of the refrigeration controller slower and more stable. In this way, the actual temperature of the cabinet can be kept very stable and near the set point, without ever having to close the solenoid valve, but rather by simply controlling the flow of refrigerant.

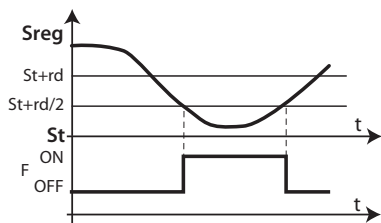

Fig. 6.ag

Key
 Sreg Control probe
 F Modulating thermostat function
 t time

Note:

- The action of OSH is weighted, based on the difference between the temperature set point and the control temperature. The lower the difference, the greater the action of OSH and vice-versa.
- OSH is active in a band of maximum equal to half of the differential rd

With double thermostat:

- the action of OSH will be determined by the thermostat with the lower difference between the set point and the actual temperature;
- the highest contribution is used, $Tf = st + rd/2$ or $Tf2 = St2 + rd/2$, as there are two bands.

Par.	Description	Def	Min	Max	UoM
OSH	Superheat offset for modulating thermostat (0 = function disabled)	0.0	0.0	60.0	K

Tab. 6.au

Example

OSH too low

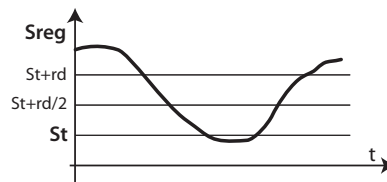

Fig. 6.ah

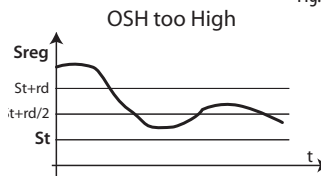

Fig. 6.ai

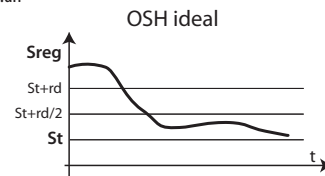

Fig. 6.aj

Key:
 Sreg=control probe
 rd = differential
 St=set point
 t= time

Support saturated temperature for pressure probe error (parameter P15)

In the event of a pressure/saturated evaporation temperature probe error, this represents the constant value used by the device to simulate the probe reading. In centralised systems, the evaporation pressure is determined by the compressor rack set point. Once this set point has been set for P15, control can continue, even if not in perfect conditions, in emergency situations.

Par.	Description	Def	Min	Max	UoM
P15	Support saturated temperature for pressure probe error	-15.0	-50.0	50.0	°C/°F

Tab. 6.av

PID control (parameters P4,P5,P6)

The opening of the electronic valve is controlled based on the difference between the superheat set point and the actual superheat calculated by the probes. The speed of variation, the reactivity and the ability to reach the set point depend on three parameters:

Kp = proportional gain, parameter P4;

Ti = integration time, parameter P5;

Td = derivative time, parameter P6;

The ideal values to be set vary depending on the applications and the utilities managed, nonetheless default values are proposed that allow good control in the majority of cases. For further details, refer to classic PID control theory.

Par.	Description	Def	Min	Max	UoM
P4	Proportional gain	15.0	0.0	100.0	-
P5	Integration time 0 = function disabled	150	0	900	s
P6	Derivative time 0 = function disabled	5.0	0.0	100.0	s

Tab. 6.aw

P4: this represents the amplification factor. It determines an action that is directly proportional to the difference between the set point and the actual superheat value. It acts on the speed of the valve, in terms of steps/°C. The valve moves P4 steps for every degree centigrade variation in the superheat, opening or closing whenever the superheat increases or decreases respectively. It also acts on the other control factors, and is valid in both normal control and with all emergency control functions. High values ==> fast and reactive valve (e.g. 20 for CO₂ - carbon dioxide applications). Low values ==> slow and less reactive valve.

P5: this represents the time required by the controller to balance the difference between the set point and the actual superheat. It practically limits the number of steps that the valve completes each second. It is only valid during normal control, the special functions in fact have their own integration time.

High values ==> slow and less reactive valve (e.g. 400 for CO₂ - carbon dioxide applications)

Low values ==> fast and reactive valve

P5 = 0 ==> integral action disabled

P6: this represents the reaction of the valve to variations in the superheat. It amplifies or reduces variations in the superheat value.
 High values ==> fast variations
 Low values ==> limited variations
 P6 = 0 ==> differential action disabled
Example. For CO₂ - carbon dioxide applications: P6=5

Smooth Lines function

The new Smooth Lines function is used to optimise evaporator capacity based on actual cooling demand, allowing more effective and stable control of cabinet temperature. Unlike the existing modulating thermostat (OSH), this function completely eliminates traditional on/off control, modulating the temperature inside the cabinet exclusively using the electronic expansion valve, and adjusting the superheat set point by adopting accurate PI control based on the effective control temperature. The main features are:

- The superheat set point for managing the electronic expansion valve can vary between a minimum (traditional set point P3) and maximum limit (P3+PHS: max. offset) using PI control (pre-configured), based on the control temperature and how far this is from the corresponding set point St
- The temperature inside the cabinet can fall slightly below the set point St, without stopping the main control, however simply closing the electronic valve
- Temperature control (and consequently the solenoid valve relay) therefore remains active at all times, while the electronic expansion valve stops the flow of refrigerant into the evaporator
- It is easy to use, as it is the instrument itself that automatically adapts control based on current operation, without requiring special parameter settings

The main benefits are

- No swings in temperature and superheat when reaching the set point
- Stable temperature and superheat control

Maximum energy savings by stabilising the load

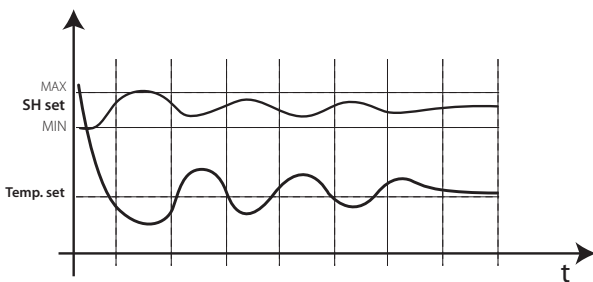

Fig. 6.ak

Par	Descrizione	Def	Min	Max	UM
PSM	Smooth Lines - Enable function	0	0	1	
PLt	Smooth Lines - Offset to stop control below set point	2.0	0.0	10.0	°C/°F
PHS	Smooth Lines - Maximum superheat offset	15.0	0.0	50.0	K

Note: Smooth Lines is not compatible with traditional Floating Suction control, and must be used with the new Rack Smart Set algorithm

Change set by parameter

A specific set of parameters, pre-loaded using the programming key MXOPZKEYA0, can be recalled during normal operation of the controller. The parameter used to make this selection is HSc (not visible as default mode), and the set chosen can range between 1 and Hdn, the number of sets available. Once having confirmed the value by pressing the SET button, MPXPRO will reboot so as to reinitialise all the control algorithms and safety functions. The set of parameters can be changed using by switching a digital input specially set to the value 13. In this case, set 1 (DI not active) and set 2 (DI active) are available to be selected. The set of parameters is changed on transition of digital input status. A set of parameters can also be recalled from the supervisor. This operation is protected by prompting for an activation code. The procedure for changing the set of parameters from the supervisor involves writing the value 1313 to parameter HSP and then selecting the required set using parameter HSc. If HSP is not set to 1313, parameter HSc will be read-only. The value of HSP is set to zero after selecting the set by HSc, 30 minutes after the last setting or when restarting the controller.

Note: when changing the set of parameters by digital input, parameter or from the supervisor, the values of the network parameters,

H0, In and Sn will be retained, ignoring the values in the preloaded set.

After selecting the set of parameters to be recalled, parameter HSS takes the value in the set that is loaded. If at least one parameter is then modified, 0.1 will be added to the value of HSS.

Example: if set 2 has been just loaded, the value of HSS will be 2.0; if the set of parameters is then modified, the new value of HSS will be 2.1.

6.10 Protectors

LowSH Low superheat

To prevent too low superheat values that may cause the return of liquid to the compressor or system instability (swings), a low superheat threshold can be defined, below which a special protection function is activated. When the superheat falls below the threshold, the system immediately enters low superheat status and activates a control action, in addition to normal control, with the aim of closing the electronic valve more quickly. In practice, the intensity of the system "reaction" is increased. If the device remains in low superheat status for a certain period, a low superheat alarm is activated, with the display showing the message 'LSH'. The low superheat signal features automatic reset, when the condition is no longer present or the controller is switched off (standby). When low superheat status is activated, the local solenoid valve can be forced closed (parameter P10).

Par.	Description	Def	Min	Max	UoM
P7	LowSH: low superheat threshold	7.0	-10.0	P3	K
P8	LowSH: integration time 0 = function disabled	15.0	0.0	240.0	s
P9	LowSH: alarm delay 0 = alarm disabled	600	0	999	s

Tab. 6.ax

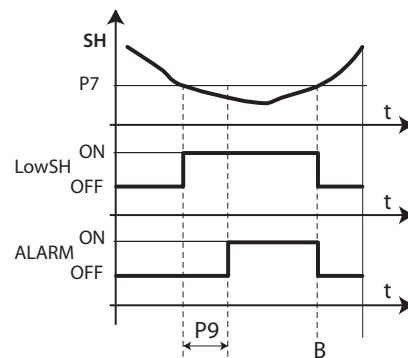

Fig. 6.al

Key

- SH Superheat
- LowSH Low superheat protection
- ALARM Alarm
- P7 LowSH threshold
- P9 Alarm delay
- t time

MOP Maximum evaporation pressure

When starting or restarting an installation, the compressors may not be able to satisfy the simultaneous refrigeration requirements of all the refrigeration utilities in the installation. This may cause an excessive increase in the evaporation pressure and consequently the corresponding saturated temperature. When the evaporation pressure, expressed in degrees (saturated), rises above the threshold, after a certain settable time the system enters MOP protection status: PID superheat control is stopped and the controller starts gradually closing the valve with an integration action to return the evaporation pressure below the threshold. The protection function has been designed to allow a gradual return to normal operating conditions, that is, when the critical conditions have ended, the controller temporarily operates with a higher superheat set point until the function is automatically reset.

Important: if this action causes the complete closing of the electronic valve, the solenoid valve is also closed, even if this is a network solenoid valve, when enabled. The alarm signal with the message 'MOP' on the display is delayed from the activation of the protection function and is automatically reset as soon as the saturated temperature falls below the threshold.

Par.	Description	Def	Min	Max	UoM
PM1	MOP: saturated evaporation temper. threshold	50.0	-50.0	50.0	°C/°F
PM2	MOP: integration time	10.0	0.0	240.0	s
PM3	MOP: alarm delay - 0 = function disabled	0	0	999	s
PM4	MOP function delay when starting control	2	0	240	s
PM5	MOP: enable close solenoid valve (optional)	0	0	1	-

Tab. 6.ay

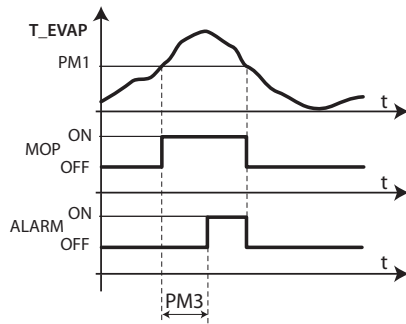

Fig. 6.am

Key

T_EVAP	Evaporation temperature	PM1	MOP threshold
MOP	MOP protection	PM3	Alarm delay
ALARM	Alarm	t	Time

PM1 represents the maximum evaporation pressure, expressed in degrees (saturated), above which the MOP protection and alarm are activated (each with its own delay times). There is a gradual return to normal operation, to avoid the critical situations arising again.

PM2 represents the integration time for the maximum evaporation pressure protection function. This replaces the normal PID control during MOP status.

PM2 = 0 ==> MOP protection and alarm disabled

PM3 represents the alarm activation delay after exceeding the MOP threshold. When the alarm is activated, the following occur:

- Message 'MOP' shown on the display
- The buzzer is activated

The alarm features automatic reset when the evaporation pressure falls below the threshold PM1.

PM4 = 0 ==> MOP alarm disabled

PM4 represents the activation delay MOP protection after the last activation of the solenoid valve.

PM5 allows the local or network solenoid valve (if available), based on the configuration of the system (see parameter r7), to be closed upon activation of the MOP alarm. If the expansion valve (0 steps) is closed completely during MOP status (before the activation of the alarm), the solenoid valve configured is also closed.

LSA - Low suction temperature

When the suction temperature falls below the threshold, the alarm is activated after the set delay, closing the electronic valve or the local and/or shared tLAN solenoid valve (if available). The alarm is reset when the suction temperature exceeds the set threshold plus the hysteresis. Reset is automatic for a maximum of four times in a two hour period. Upon the fifth activation in such period, the alarm is saved and requires manual reset from the user terminal or supervisor.

Par.	Description	Def	Min	Max	UoM
P11	LSA: low suction temperature threshold	-45.0	-50.0	50.0	°C/°F
P12	LSA: alarm delay - 0 = alarm disabled	600	0	999	s
P13	LSA: alarm differential (°C) - 0 = reset always automatic	10.0	0.0	60.0	°C/°F
P10	Enable close solenoid valve (optional) for low superheat (LowSH) and/or low suction temperature (LSA)	0	0	1	-

Tab. 6.az

P11 represents the suction temperature below which the alarm is activated, after the corresponding delay. The threshold for resetting the alarm is represented by this threshold plus the hysteresis P13.

P12 represents the alarm activation delay after exceeding the threshold P11. When the alarm is activated, the following occur:

- message 'LSA' shown on the display;
- the buzzer is activated

The alarm features automatic reset for the first four activations over a two hour period, then becomes manual reset.

P12 = 0 ==> LSA alarm disabled

P13 represents the hysteresis used to deactivate the LSA alarm.

P13 = 0 ==> reset always automatic.

P10 allows the network solenoid valve to be closed in the event of low superheat (LowSH) and/or low suction temperature alarm (LSA).

- P10=1 (default): the unit that signals the LowSH and/or LSA status, as well as closing the local solenoid valve, propagates the request across the local network (LAN). This enables propagation of the closing request over the tLAN network to the Master.

To effectively close the network solenoid valve (if available)(P10=1), the solenoid on the Master must be enabled as a network valve (parameter r7=1), the only type that can accept network requests.

- P10=0: the unit that signals the LowSH and/or LSA status does not enable the closing of the network and local solenoid valve.

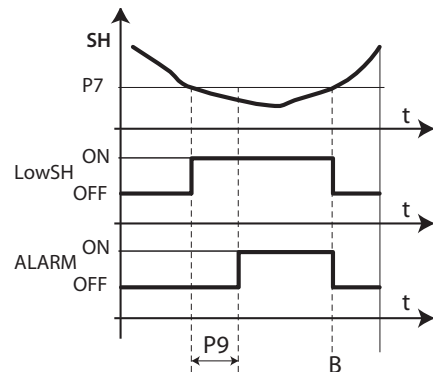

Fig. 6.an

Key

T_SUCT	Suction temperature	P13	LSA: Alarm differential
P11	LSA: low suction temperature threshold	t	time
P12	LSA: alarm delay	LSA	LSA protection

LOP Minimum evaporation pressure

Function useful above all for stand-alone refrigeration controllers, used to prevent the evaporation pressure from remaining excessively low for too long. When the evaporation pressure, expressed in degrees (saturated), falls below the threshold, the LOP protection is activated, which adds an integration action to normal PID control, specifically devised to be more reactive as regards the opening of the valve. The PID control remains active, as the superheat must continue to be monitored as to avoid flooding the compressors. The LOP alarm is delayed from the activation of the protection function, both are reset automatically when the pressure value, in degrees (saturated), exceeds the threshold.

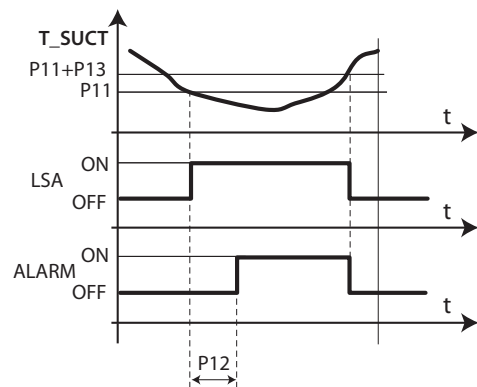

Fig. 6.ao

Key

T_EVAP	Evaporation temperature	PL1	LOP: threshold
LOP	LOP protection	PL3	LOP : alarm delay
ALARM	Alarm	t	Time

Par.	Description	Def	Min	Max	UoM
PL1	LOP: minimum saturated evaporation temperature threshold	-50.0	-50.0	50.0	°C/°F
PL2	LOP: integration time	0.0	0.0	240.0	s
PL3	LOP: alarm delay 0 = alarm disabled	0	0	240	s

Tab. 6.ba

PL1 represents the evaporation pressure, expressed in degrees (saturated), below which the LOP protection is activated. The protection is deactivated immediately when the pressure exceeds this threshold.

PL2 represents the integration constant used during the activation of the LOP protection. This integration time acts in parallel to normal PID control. PL2 = 0 ==> LOP protection and alarm disabled

PL3 represents the alarm activation delay after exceeding the LOP threshold. When the alarm is activated, the following occur:

- message 'LOP' shown on the display;
- the buzzer is activated.

The alarm features automatic reset when the evaporation pressure rises above the threshold PL1.

PL3 = 0 ==> LOP alarm disabled

Manual valve positioning from supervisor (parameters only visible on the supervisor)

Par.	Description	Def	Min	Max	UoM
PMP	Enable manual expansion valve positioning 0 = disabled; 1 = enabled	0	0	1	-
PMu	Manual valve position	-	0	600	step

Tab. 6.bb

PMP is used to enable/disable manual positioning of the valve.

- PMP = 0: manual positioning disabled;
- PMP = 1: manual positioning enabled.

If manual positioning is enabled, this is used to set the manual opening of the electronic valve. The value is expressed in steps for stepper valves, and as a % for PWM valves.

Enabling high current valve driving

Par.	Description	Def	Min	Max	U.M.
Phc	Enable high current valve driving 0 = disable; 1 = enable	0	0	1	-

Tab. 6.bc

Set Phc to 1 when E3V45 or higher valves are used

- Phc = 0: high current disabled;
- Phc = 1: high current enabled.

Read-only variables

Par.	Description	Def	Min	Max	UoM
PF	Valve opening steps (supervisor)	-	0	-	step
SH	Superheat	-	-	-	K
PPU	Valve opening percentage	-	-	-	%
tGS	Superheated gas temperature	-	-	-	°C/°F
tEu	Saturated evaporation temperature	-	-	-	°C/°F

Tab. 6.bd

PF: status variable that only displays, solely from the supervisor, the current position of the electronic valve calculated by the controller. System malfunctions may cause this value to be different from the effective position of the valve. Not used with PWM valves.

SH: status variable that only displays of the superheat value calculated by MPXPRO and used to control of valve.

PPU: status variable that only displays the electronic valve opening as a percentage, for both stepper and PWM valves.

tGS: status variable that only displays the evaporator outlet temperature read by the corresponding probe (advanced parameter /Fd).

tEu: status variable that only displays the saturated evaporation temperature calculated by the corresponding evaporation pressure probe or read directly by the NTC probe (advanced parameter /FE).

PWM valve modulation period (parameter Po6)

Par.	Description	Def	Min	Max	UoM
Po6	PWM expansion valve Ton + Toff period	6	1	20	s

Tab. 6.be

This represents the modulation period (in seconds) for the PWM electronic expansion valve only (DC/AC). The opening of the PWM valve, performed based on the PID parameters, refers to the period Po6 (in seconds) and not to the maximum 480 steps for opening the stepper valve. All the remarks made for the stepper valve can thus apply to the PWM valves, considering these differences.

6.11 Refrigerant flow control

This new function uses a stepper or PWM valve to control liquid refrigerant flow. The function is activated by setting the value of parameter P1 = 3, 4, 5. Typical systems that require this type of control are pumped CO2 systems. In these systems, there are cabinets that are not refrigerated by expansion of the refrigerant, but rather by the passage of compressed, liquefied gas through the evaporator. The function uses the same type of control currently used for the Smooth Lines function, regarding the following variables:

- St: control set point
- rd: activation differential
- SrG: control probe temperature
- PSP: proportional coefficient
- PSI: integral time
- PSd: derivative time

The last three variables in the list are the control PID configuration parameters. The function opens the valve to prevent an increase in the temperature measured (SrG). Parameter PLt is used as a cut-off offset -off: if $SrG \leq (St - PLt)$, control is interrupted and the valve is closed (0%). If an error occurs relating to the temperature probe/probes used, the valve is closed (0%).

Note: 0-10V modulation (P1 = 3), if selected, replaces fan modulation, irrespective of their configuration.

The control parameters are illustrated in the following table :

Par.	Description	Def	Min	Max	UoM
P1	3 = 0-10V modulation for refrigerant control, 4 = PWM valve (on driver board) for refrigerant control 5 = Carel E2V valve modulation for refrigerant control	0	0	5	-
St	Control set point	50	r1	r1	°C/°F
rd	Control differential	2	0.1	20	°C/°F
PSP	Control proportional coefficient	5	0	100	-
PSI	Control integral time	120	0	800	s
PSd	Control derivative time	0	0	100	s

Tab. 6.b

The function uses a hysteresis when opening/closing the valve. The algorithm, configured using parameter rMu between 0% and 100%, is represented in the following figure:

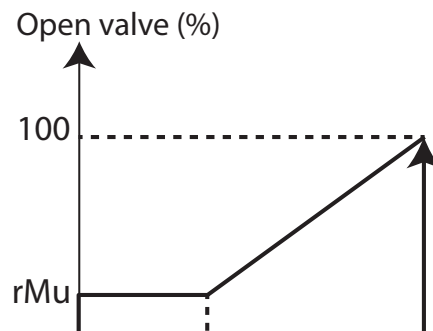

Par.	Description	Def	Min	Max	UoM
rMu		0	0	100	%

7. OPTIONAL CONFIGURATIONS

7.1 Other configuration parameters

The other configuration parameters that need to be set when commissioning the controller concern :

- the measurement stability of analogue probes;
- the selection of the user terminal and/or remote display;
- the enabling of the keypad, remote control and buzzer (accessory);
- the standard display on the user terminal and the remote display;
- the display of messages / alarms on the remote display.
- the display in °C / °F and the decimal point;
- the locking of the buttons on the user terminal;
- the availability of the RTC (real time clock);

/2: Analogue probe measurement stability

Par.	Description	Def	Min	Max	UoM
/2	Analogue probe measurement stability	4	1	15	-

Tab. 7.a

Defines the coefficient used to stabilise the temperature measurement. Low values assigned to this parameter mean a prompt response of the probe to variations in temperature; the reading however becomes mostly sensitive to disturbance. High values high slow down the response but guarantee greater immunity to disturbance, that is, a more stable, more precise and filtered reading.

H2: Disable keypad and remote control functions

Some functions relating to the use of the keypad can be disabled, for example setting the parameters and the set point if the controller is exposed to the public.

Par.	Description	Def	Min	Max	UoM
H2	Disable keypad and remote control functions	1	0	5	-

Tab. 7.b

Below is a summary of the modes that are active for each setting:

H2	Buttons					Functions			
	AUX	Prg/mute	UP/CC (continuous cycle)	DOWN/DEF (defrost)	Set	Edit type F parameters	Program Set point	Settings from remote control	
0	YES	YES	YES	YES	YES	NO	NO	YES	
1	YES	YES	YES	YES	YES	YES	YES	YES	
2	YES	YES	YES	YES	YES	NO	NO	NO	
3	YES	YES	YES	YES	YES	YES	YES	NO	
4	YES	YES	NO	NO	YES	NO	YES	YES	
5	YES	YES	NO	NO	YES	NO	NO	YES	

Tab. 7.c

When the set point and type F parameter setting functions are inhibited, neither the set point nor the type F parameters can be changed, while their values can still be displayed. The type C parameters, on the other hand, being password protected, can also be set from the keypad, following the procedure described previously. With the remote control disabled, only the values of the parameters can be displayed, but they cannot be modified; in addition, the mute, defrost, continuous cycle, and aux functions are disabled.

Note: If H2=2 or H2=3 is set on the remote control, this is immediately disabled when pressing ESC. To re-enable the remote control, set 'H2'=0 or 'H2'=1 from the keypad on the user terminal, on the supervisor or in VPM.

/t1, /t2, /t: Display on user terminal and on remote display

Parameters /t1 and /t2 select the variable shown on the display during normal operation. In the event of alarms, /t enables the display of alarms on the remote display. For example, during defrost if /t=0 and d6 = 0, the display does not show dEF alternating with the temperature set for /t2, while when /t=1 the display shows dEF alternating with the temperature set for /t2.

Par.	Description	Def	Min	Max	UoM
/t1	Display on user terminal 0 = Terminal disabled 1 to 11 = Probe 1 to 11 12 = Control probe 13 = Virtual probe 14 = Set point	12	0	14	-

/t2	Display on remote display see /t1	12	0	14	-
/t	Display signals / alarms on remote display 0 = disabled, 1 = enabled	0	0	1	-

Tab. 7.d

/5, /6: Temperature unit of measure and display decimal point

Par.	Description	Def	Min	Max	UoM
/5	Temperature unit of measure: 0= °C/barg, 1= °F/psig	0	0	1	-
/6	Display decimal point: 0 = enabled, 1 = disabled	0	0	1	-

Tab. 7.e

Note: the pressure probe minimum and maximum limits vary based on the selected unit of measure

H4: Disable buzzer

The buzzer on the user terminal can be disabled by setting parameter H4.

Par.	Description	Def	Min	Max	UoM
H4	Terminal buzzer: 0 = enabled; 1= disabled	0	0	1	-

Tab. 7.f

H6: Terminal keypad lock configuration

Parameter H6 is used to disable the functions relating to the individual buttons on the keypad.

Par.	Description	Def	Min	Max	UoM
H6	Terminal keypad lock configuration	0	0	15	-

Tab. 7.g

Buttons / Associated function

Set	def	▲	Prg
Network defrost	Local defrost Network defrost Continuous cycle Enter HACCP	Enable /Disable aux/light output Continuous cycle	Mute Enter HACCP

Tab. 7.h

Active buttons

H6	Set	def	▲	Prg	H6	Set	def	▲	Prg
0	YES	YES	YES	YES	8	YES	YES	YES	NO
1	NO	YES	YES	YES	9	NO	YES	YES	NO
2	NO	NO	YES	YES	10	YES	NO	YES	NO
3	NO	NO	NO	YES	11	NO	NO	YES	NO
4	YES	YES	NO	YES	12	YES	YES	NO	NO
5	NO	YES	NO	YES	13	NO	YES	NO	NO
6	YES	NO	NO	YES	14	YES	NO	NO	NO
7	NO	NO	NO	YES	15	NO	NO	NO	NO

Tab. 7.i

Htc: Clock fitted

Par.	Description	Def	Min	Max	UoM
Htc	Clock fitted: 0 = not fitted	0	0	1	-

Tab. 7.j

Indicates whether or not the real time clock is fitted:

- Htc = 0: clock not fitted, Htc = 1: clock fitted.

If the parameter is set to 0 and the operator physically installs the optional real time clock card (MX3OP48500) with the controller off, when restarting the parameter is automatically set to 1. If set to 1 when the clock is not fitted, the 'Etc' alarm is activated.

POM: Cooling capacity indication

A value can be written (not associated with any control logic) to indicate cabinet cooling capacity. The parameter accepts values from 0.0 to 200.0, and can be both from the supervisor and from the user interface.

Par.	Description	Def	Min	Max	UoM.
POM	Unit cooling capacity indication	4.0	0.0	200.0	-

Tab. 7.k

8. TABLE OF PARAMETERS

Parameter levels: F = frequent, C=configuration (password=22), A=advanced (password=33)

Par.	Description	Def	Min	Max	UoM	Type
 /Pro (=PROBES)						
/2	Analogue probe measurement stability	4	1	15	-	A
/4	Virtual probe composition 0 = Outlet probe Sm 100 = Intake probe Sr	0	0	100	%	C
/5	Temperature unit of measure 0= °C/barg, 1= °F/psig	0	0	1	-	A
/6	Display decimal point 0 = Enabled, 1 = Disabled	0	0	1	-	A
rHS	Virtual probe composition for glass temperature probe estimate 0 = Outlet probe Sm 100 = Intake probe Sr	20	0	100	%	NV
/t	Display signals / alarms on remote display 0 = Disabled, 1 = Enabled	0	0	1	-	A
/t1	Display on user terminal 0 = User terminal disabled 1 = Probe 1 2 = Probe 2 3 = Probe 3 4 = Probe 4 5 = Probe 5 6 = Probe 6 7 = Probe 7 8 = Serial probe 8 9 = Serial probe 9 10 = Serial probe 10 11 = Serial probe 11 12 = Control probe 13 = Virtual probe 14 = Set point	12	0	14	-	C
/t2	Display on remote display 0 = Remote display disabled 1 = Probe 1 2 = Probe 2 3 = Probe 3 4 = Probe 4 5 = Probe 5 6 = Probe 6 7 = Probe 7 8 = Serial probe 8 9 = Serial probe 9 10 = Serial probe 10 11 = Serial probe 11 12 = Control probe 13 = Virtual probe 14 = Set point	12	0	14	-	A
/P1	Type of probe, group 1 (S1, S2, S3) 0 = NTC Standard Range -50T90 °C 1 = PTC Standard Range -50T150 °C 2 = PT1000 Standard Range -50T150 °C 3 = NTC L243 Standard Range -50T90 °C	0	0	3	-	A
/P2	Type of probe, group 2 (S4, S5) 0 = NTC Standard Range -50T90 °C 1 = PTC Standard Range -50T150 °C 2 = PT1000 Standard Range -50T150 °C 3 = NTC L243 Standard Range -50T90 °C	0	0	3	-	A
/P3	Type of probe, group 3 (S6) 0 = NTC Standard Range -50T90 °C 1 = PTC Standard Range -50T150 °C 2 = PT1000 Standard Range -50T150 °C 3 = NTC L243 Standard Range -50T90 °C 4 = 0 to 5V ratiometric probe	0	0	4	-	A
/P4	Type of probe, group 4 (S7) 0 = NTC Standard Range -50T90 °C 1 = PTC Standard Range -50T150 °C 2 = PT1000 Standard Range -50T150 °C 3 = NTC L243 Standard Range -50T90 °C 4 = 0 to 5V ratiometric probe 5 = 0 to 10 V input 6 = 4 to 20 mA input	0	0	6	-	A
/P5	Type of probe, group 5: serial probes (S8 to S11)	0	0	15	-	A
/FA	Assign outlet temperature probe (Sm) 0 = Function disabled 1 = Probe S1 2 = Probe S2 3 = Probe S3 4 = Probe S4 5 = Probe S5 6 = Probe S6 7 = Probe S7 8 = Serial probe S8 9 = Serial probe S9 10 = Serial probe S10 11 = Serial probe S11	1	0	11	-	C
/Fb	Assign defrost temperature probe (Sd) - See /FA	2	0	11	-	C
/Fc	Assign intake temperature probe (Sr) - See /FA	3	0	11	-	C
/Fd	Assign superheated gas temperature probe (tGS) - See /FA	0	0	11	-	A
/FE	Assign saturated evaporation pressure/temperature probe (PEu/tEu) - See /FA	0	0	11	-	A
/FF	Assign defrost temperature probe 2 (Sd2) - See /FA	0	0	11	-	A
/FG	Assign auxiliary temperature probe 1 (Saux1) - See /FA	0	0	11	-	A
/FH	Assign auxiliary temperature probe 2 (Saux2) - See /FA	0	0	11	-	A
/FI	Assign ambient temperature probe (SA) - See /FA	0	0	11	-	A
/FL	Assign ambient humidity probe (SU) - See /FA	0	0	11	-	A
/FM	Assign glass temperature probe (Svt) - See /FA	0	0	11	-	A
/Fn	Assign dewpoint value (SdP) to a serial probe 0 = Function disabled 1 = Serial probe S8 2 = Serial probe S9 3 = Serial probe S10 4 = Serial probe S11	0	0	4	-	A
/c1	Probe 1 calibration	0	-20	20	(°C/°F)	F
/c2	Probe 2 calibration	0	-20	20	(°C/°F)	F
/c3	Probe 3 calibration	0	-20	20	(°C/°F)	F
/c4	Probe 4 calibration	0	-20	20	(°C/°F)	A
/c5	Probe 5 calibration	0	-20	20	(°C/°F)	A
/c6	Probe 6 calibration	0	-20	20	(°C/°F/ barg/ RH%)	A

Par.	Description	Def	Min	Max	UoM	Type
/c7	Probe 7 calibration	0	-20	20	(°C/°F/ barg/ RH%)	A
/U6	Maximum value of probe 6	9.3	/L6	160 if /5=0 999 if /5=1	barg/ RH%	A
/L6	Minimum value of probe 6	-1	-20 if /5=0 -90 if /5=1	/U6	barg/ RH%	A
/U7	Maximum value of probe 7	9.3	/L7	160 if /5=0 999 if /5=1	barg/ RH%	A
/L7	Minimum value of probe 7	-1.0	-20 if /5=0 -90 if /5=1	/U7	barg/ RH%	A



CtL (Control)

OFF	ON/OFF control: 0 = ON; 1 = OFF;	0	0	1	-	A
St	Set point	50	r1	r2	°C/°F	F
St2	Intake probe set point with "Double thermostat"	50	r1	r2	°C/°F	A
rd	Set point differential St	2	0.1	20	°C/°F	F
rd2	Set point differential St2 with "Double thermostat": 0.0 = function disabled	0	0	20	°C/°F	A
r1	Minimum set point	-50	-50	r2	°C/°F	A
r2	Maximum set point	50	r1	50	°C/°F	A
r3	End defrost signal by timeout: 0 = disabled, 1 = enabled	0	0	1	-	A
r4	Automatic night-time set point variation	0	-50	50	°C/°F	C
r6	Probe for night-time control: 0 = virtual probe Sv; 1 = intake probe Sr	0	0	1	-	C
ro	Control offset with probe error	0.0	0.0	20	°C/°F	A
r7	Master solenoid valve configuration: 0 = local valve; 1 = network valve (connected to Master)	0	0	1	-	C
rSu	Suction valve closure delay in normal regulation mode	0	0	999	sec	C
rMu	Minimum opening % for refrigerant control	0	0	100	%	A
CLt	Maximum time for Clean status	0	0	999	min	A
Stt	Maximum time for Standby status	0	0	240	min	A



CMP (compressor)

c0	Delay enable compressor and evaporator fans on power-up	0	0	240	min	A
c1	Minimum time between successive starts	0	0	15	min	A
c2	Minimum OFF time	0	0	15	min	A
c3	Minimum ON time	0	0	15	min	A
c4	ON time for duty setting operation (Toff = 15 minutes fixed) 0 = compressor/valve always OFF; 100 = compressor/valve always ON	0	0	100	min	A
cc	Running time in continuous cycle	1	0	15	hour	A
c6	Low temperature alarm bypass time after continuous cycle	60	0	240	min	A
c7	Defrost priority over continuous cycle 0 = no, 1 = yes	0	0	1	-	A



dEF (defrost)

d0	Type of defrost 0 = heater by temperature 1 = hot gas by temperature 2 = heater by time 3 = hot gas by time 4 = heater by time with temp. control 5 = multiplexed hot gas by temperature 6 = multiplexed hot gas by time	0	0	6	-	C
d2	End defrost synchronized by Master 0 = not synchronized; 1 = synchronized	1	0	1	-	A
d3	Disable send network defrost control (for Master); 0: disabled; 1: enabled Ignore network defrost control (for Slave); 0: disabled; 1: enabled	0	0	1	-	A
dl	Maximum interval between consecutive defrosts	8	0	240	hour	C
dt1	End defrost temperature (read by Sd)	8	-50.0	50.0	°C/°F	F
dt2	End defrost temperature (read by Sd2)	8	-50.0	50.0	°C/°F	A
dP1	Maximum defrost duration	45	1	240	min	F
dP2	Maximum secondary evaporator defrost duration	45	1	240	min	A
d4	Defrost on power-up: 0 = disabled ; 1 = enabled (Master = network defrost; Slave = local defrost)	0	0	1	-	A
d5	Defrost delay on power-up or (for Slave) after control from Master 0 = delay disabled	0	0	240	min	A
d6	Display on terminals during defrost 0 = temperature alternating with 'dEF' 1 = freeze display 2 = 'dEF'	1	0	2	-	C
dd	Dripping time after defrost (fans off): 0 = no dripping	2	0	15	min	A
d7	Skip defrost: 0 = disabled; 1 = enabled;	0	0	1	-	A
d8	Bypass high temperature alarm time after defrost	30	1	240	min	C
d9	Defrost priority over compressor protection times 0 = protection times observed; 1 = protection times not observed	1	0	1	-	A
Sd1	Defrost probe	-	-	-	°C/°F	F
Sd2	Secondary evaporator defrost probe	-	-	-	°C/°F	A
dC	Time base for defrost: 0 = dl in hours, dP1, dP2 and ddP in min; 1 = dl in minutes, dP1, dP2 and ddP in seconds	0	0	1	-	A
d10	Defrost time in "Running time" mode: 0 = function disabled	0	0	240	min	A
d11	Defrost temperature threshold in "Running time" mode	-30	-50	50	°C/°F	A
d12	Pressure probe alarm management during defrost probe error update supervisor 0 disabled enabled 1 enabled enabled 2 disabled disabled 3 enabled disabled	0	0	3	-	A
ds1	Compressor off time in "Sequential stop" defrost mode: 0 = function disabled	0	0	45	min	A

Par.	Description	Def	Min	Max	UoM	Type
dS2	Compressor operating time in "Sequential stop" defrost mode	120	0	240	min	A
ddt	Additional end defrost temperature delta in "Power defrost" mode	0.0	-20.0	20.0	°C/°F	A
ddP	Additional maximum defrost time delta in "Power defrost" mode	0	0	60	min	A
dn	Nominal "Skip defrost" duration	75	0	100	%	A
d1S	Number of daily defrosts (td1) 0 = Disabled 1 = 24 hours 0 minutes 2 = 12 hours 0 minutes 3 = 8 hours 0 minutes 4 = 6 hours 0 minutes 5 = 4 hours 48 minutes 6 = 4 hours 0 minutes 7 = 3 hours 26 minutes 8 = 3 hours 0 minutes 9 = 2 hours 40 minutes 10 = 2 hours 24 minutes 11 = 2 hours 11 minutes 12 = 2 hours 0 minutes 13 = 1 hour 0 minutes 14 = 30 minutes	0	0	14	-	C
d2S	Number of daily defrosts (td2) see d1S	0	0	14	-	C
dH1	Pump down phase duration: 0 = pump down disabled	0	0	999	s	A
dHG	Type of multiplexed hot gas defrost 0 = equalizing valve normally closed 1 = equalizing valve normally open	0	0	1	-	A
dSb	Valve position during defrost: 0: valve positioned as defined by the type of defrost selected; 1: valve forced closed; 2 - 100: % opening	0	0	100	%	A

⚠ ALM (Alarm)

AA	Assign probe for high (AH) and low (AL) temperature alarms 1 = control (Sreg) 2 = virtual (Sv) 3 = outlet (Sm) 4 = defrost (Sd) 5 = intake (Sr) 6 = superheated gas (tGS) 7 = saturated evaporation temp. (tEu) 8 = auxiliary defrost (Sd2) 9 = auxiliary (Saux) 10 = auxiliary 2 (Saux2) 11 = ambient temperature (SA) 12 = ambient humidity (SU) 13 = glass temperature (Svt) 14 = dewpoint (SdP)	1	1	14	-	F
AA2	Assign probe for high (AH2) and low (AL2) temperature alarms (see AA)	5	1	14	-	A
A0	High and low temperature alarm reset differential	2.0	0.1	20.0	°C/°F	F
A1	Alarm thresholds (AL, AH) relative to the set point St or absolute: 0 = relative; 1 = absolute	0	0	1	-	F
A2	Alarm thresholds (AL2, AH2) relative to the set point St2 or absolute: 0 = relative; 1 = absolute	0	0	1	-	A
AL	Low temperature alarm threshold	4	-50.0	50.0	°C/°F	F
AH	High temperature alarm threshold	10	-50.0	50.0	°C/°F	F
AL2	Low temperature alarm 2 threshold	0	-50.0	50.0	°C/°F	A
AH2	High temperature alarm 2 threshold	0	-50.0	50.0	°C/°F	A
Ad	Delay time for high and low temperature alarms (AH, AL)	120	0	240	min	F
Ad2	Delay time for high and low temperature alarms (AH2, AL2)	30	1	240	min	C
A4	Configure digital input DI1 on S4 0 = input not active 1 = immediate external alarm 2 = delayed external alarm 3 = enable defrost 4 = start defrost 5 = door switch with compressor and evaporator fans OFF 6 = remote ON/OFF 7 = curtain switch 8 = start/stop continuous cycle 9 = monitor input status 10 = timed digital input 11 = switch in Standby status 12 = switch in Clean status 13 = change working set 14 = door switch without stopping control	0	0	14	-	C
A5	Configure digital input DI2 on S5 see A4	0	0	14	-	C
A6	Configure solenoid/compressor control during external alarm (immediate or delayed) with fixed 15 min OFF time 0 = always OFF; 100 = always ON	0	0	100	min	A
A7	Delay time for delayed external alarm	0	0	240	min	C
A8	Configure function of virtual digital input see A4	0	0	8	-	A
A9	Select digital input propagated from Master to Slaves (only on Master) 0 = from supervisor 1 = DI1 2 = DI2 3 = DI3 4 = DI4 5 = DI5	0	0	5	-	A
A10	Configure function of digital input DI3 on S6 see A4	0	0	14	-	C
A11	Configure function of digital input DI4 on S7 see A4	0	0	14	-	C
A12	Configure function of digital input DI5 see A4	0	0	14	-	C
Ar	Signal alarms from Slave to Master: 0 = not enabled; 1 = enabled	1	0	1	-	A
A13	Hot gas safety procedure for Slave offline: 0 = not enabled; 1 = enabled	0	0	1	-	A
Add	High temperature alarm bypass time for door open	30	1	240	min	C

🌀 Fan (Evaporator fans)

F0	Evaporator fan management 0 = always on 1 = activation based on Sd - Sv (or Sd - Sm in double thermostat) 2 = activation based on Sd	0	0	2	-	C
F1	Evaporator fan activation threshold (only if F0 = 1 or 2)	-5.0	-50.0	50.0	°C/°F	F
F2	Evaporator fans with compressor off 0 = see F0; 1 = always off	1	0	1	-	C
F3	Evaporator fans during defrost 0 = on; 1 = off	1	0	1	-	C
Fd	Post dripping time after defrost (fans off with control active)	1	0	15	min	C
Frd	Fan activation differential (including variable speed)	2.0	0.1	20	°C/°F	F
F5	Evaporator fan cut-off temperature (hysteresis 1°C)	50.0	F1	50.0	°C/°F	F
F6	Maximum evaporator fan speed	100	F7	100	%	A
F7	Minimum evaporator fan speed	0	0	F6	%	A
F8	Evaporator fan peak time 0 = function disabled	0	0	240	s	A
F9	Select fan control with output PWM1/2 (with phase cutting speed control) 0 = by pulse; 1 = by duration	1	0	1	-	A
F10	Evaporator fan forcing time at maximum speed 0 = Eud function disabled	0	0	240	min	A

Par.	Description	Def	Min	Max	UoM	Type
Eud (Electronic valve)						
P1	Electronic valve 0 = not present; 1 = PWM valves; 2 = CAREL E2V valve 3 = 0-10V modulation for refrigerant control 4 = PWM valve modulation for refrigerant control 5 = Carel E2V valve modulation for refrigerant control	0	0	5	-	A
P3	Superheat set point	10.0	0.0	25.0	K	F
P4	Proportional gain	15.0	0.0	100.0	-	A
P5	Integration time: 0 = function disabled	150	0	900	s	A
P6	Derivative time: 0 = function disabled	5.0	0.0	100.0	s	A
P7	LowSH: low superheat threshold	7.0	-10.0	P3	K	F
P8	LowSH: integration time - 0 = function disabled	15.0	0.0	240.0	s	A
P9	LowSH: alarm delay - 0 = alarm disabled	600	0	999	s	A
P10	Enable close solenoid valve for low superheat (LowSH) and/or low suction temperature (LSA) 1 = closing enabled	0	0	1	-	A
P11	LSA: low suction temperature threshold	-45.0	-50.0	50.0	°C/°F	A
P12	LSA: alarm delay 0 = alarm disabled	600	0	999	s	A
P13	LSA: alarm differential (°C) 0 = reset always automatic	10.0	0.0	60.0	°C/°F	A
P14	Enable valve alarm at end travel ("blo") 1 = signal enabled	1	0	1	-	A
P15	Support saturated temperature for pressure probe error	-15.0	-50.0	50.0	°C/°F	A
PH	Type of refrigerant 0 = Gas custom 6= R507A, 12= R728, 18= R423A, 24=HTR01, 30= R170, 36= R452A, 1= R22, 7= R290, 13= R1270, 19= R407A, 25=HTR02, 31= R442A, 37= R508B, 2= R134a, 8= R600 14= R417A, 20= R427A, 26=R23, 32= R447A, 38= R452B, 3= R404A, 9= R600a 15= R422D, 21= R245FA, 27= R1234yf, 33= R448A, 39= R513A, 4= R407C, 10= R717, 16= R413A, 22= R407F, 28= R1234ze, 34= R449A, 40= R454B 5= R410A, 11= R744, 17= R422A, 23=R32, 29= R455A, 35= R450A,	3	0	40	-	A
OSH	Superheat offset for modulating thermostat 0 = function disabled	0.0	0.0	60.0	K	A
Phr	Enable fast update of the valve parameters to supervisor 0 = fast update disabled	0	0	1	-	A
PM1	MOP: maximum saturated evaporation temperature threshold	50.0	-50.0	50.0	°C/°F	A
PM2	MOP: integration time	10.0	0.0	240.0	s	A
PM3	MOP: alarm delay 0 = function disabled	0	0	999	s	A
PM4	MOP: delay activation of function when starting control	2	0	240	s	A
PM5	MOP: enable close solenoid valve 0 = closing disabled; 1 = closing enabled	0	0	1	-	A
PL1	LOP: minimum saturated evaporation temperature threshold	-50.0	-50.0	50.0	°C/°F	A
PL2	LOP: integration time	0.0	0.0	240.0	s	A
PL3	LOP: alarm delay 0 = function disabled	0	0	240	s	A
SH	Superheat	-	-	-	K	F
PPU	Valve opening percentage	-	-	-	%	F
tGS	Superheated gas temperature	-	-	-	°C/°F	F
tEu	Saturated evaporation temperature	-	-	-	°C/°F	F
/cE	Saturated evaporation temperature calibration	0.0	-20.0	20.0	°C/°F	A
Po6	PWM expansion valve Ton + Toff period	6	1	20	s	A
cp1	Initial valve position when control starts	30	0	100	%	A
Pdd	Initial valve position maintenance time after defrost	10	0	30	min	A
PSb	Valve standby position	0	0	400	step	A
PF	Valve opening steps (supervisor)	-	0	-	step	NV
PMP	Enable manual expansion valve positioning 0 = disabled; 1 = enabled	0	0	1	-	A
PMu	Manual valve position	-	0	600	step	A
Phc	Enable high current valve driving	0	0	1	-	A
PSM	Smooth Lines - Enable function	0	0	1	-	A
PLt	Smooth Lines - Offset to stop control below set point	2.0	0.0	10.0	°C/°F	A
PHS	Smooth Lines - Maximum superheat offset	15.0	0.0	50.0	K	A
PSd	Control derivative time (Smooth Lines or liquid control)	0	0	100	s	NV
PSI	Control integral time (Smooth Lines or liquid control)	120	0	800	s	A
PSP	Control prop. coefficient (Smooth Lines or liquid control)	5	0	100	-	A

AUX CnF (Configuration)

In	Type of unit 0 = Slave; 1 = Master	0	0	1	-	C
Sn	Number of slaves in the local network 0 = no Slave	0	0	5	-	C
H0	Serial or Master Slave network address	199	0	199	-	C
H1	Configure function of output AUX1 0 = No function 7 = Auxiliary evaporator defrost 1 = Normally de-energized alarm 8 = Evaporator fans 2 = Normally energized alarm 9 = Anti-sweat heaters 3 = Auxiliary 10 = Suction valve 4 = Auxiliary serving MASTER on the Slaves 11 = Equalizing valve. 5 = Light 12 = Solenoid valve. 6 = Light serving the Master on the Slaves 13 = Output associated with timer function 14 = Condensate drain heaters	8	0	14	-	C
H2	Disable keypad and remote control functions 1 = keypad and remote control enabled	1	0	5	-	A
H3	Remote control enabling code 0 = programming from remote control without code	0	0	255	-	A
H4	Terminal buzzer (if present) 0 = enabled; 1 = disabled	0	0	1	-	A
H5	Configure function of output AUX2 see H1	2	0	14	-	C
H6	Terminal keypad lock configuration	0	0	15	-	A
H7	Configure function of output AUX3 see H1	5	0	14	-	C
H8	Output switched with time bands 0 = Light; 1 = AUX	0	0	1	-	C

Par.	Description	Def	Min	Max	UoM	Type
H9	Select function associated with the "aux" button on the user terminal 0 = Light; 1 = AUX.	0	0	1	-	C
H10	Configure compressor digital output logic 0 = direct logic; 1 = reverse logic	0	0	1	-	A
H11	Configure evaporator fan digital output logic 0 = direct logic; 1 = reverse logic	0	0	1	-	A
H13	Configure function of output AUX4 see H1	12	0	14	-	C
Hdn	Number of default parameter sets available	0	0	6	-	NV
Htc	Clock fitted 0 = not fitted	0	0	1	-	A
rHu	Manual anti-sweat heater activation percentage (of period 'rHt') 0 = function disabled	70	0	100	%	A
rHt	Manual anti-sweat heater activation period 0 = function disabled	5	0	180	min	A
rHo	Offset for anti-sweat heater modulation	2.0	-20.0	20.0	°C/°F	A
rHd	Differential for anti-sweat heater modulation	0.0	0	20.0	°C/°F	A
rHL	Type of PWM output load for anti-sweat heater modulation 0 = resistive; 1 = inductive	0	0	1	-	A
dlt	Timer duration (timed input)	0	0	999	min	A
HSc	Select the set of parameters used	1	1	Hdn	-	NV
HSS	Set of parameters in use (+0.1 if subsequently modified)	1.0	1.0	6.1	-	A
H14	Time light stays on after closing the door	0	0	240	min	C
Hr1	Reverse logic for digital input 1	0	0	1	-	A
Hr2	Reverse logic for digital input 2	0	0	1	-	A
Hr3	Reverse logic for digital input 3	0	0	1	-	A
Hr4	Reverse logic for digital input 4	0	0	1	-	A
Hr5	Reverse logic for digital input 5	0	0	1	-	A
POM	Unit cooling capacity indication	4.0	0	200.0	-	A
rHA	Coefficient A for glass temperature probe estimate	2	-20	20	°C/°F	NV
rHb	Coefficient B for glass temperature probe estimate	22	0	100	-	NV

⚠️ 🕒 HSt (Alarm log)

HS0 to 9	Alarm 0 to 9 (press Set)	-	-	-	-	A
---	Alarm 0 to 9 - Code	-	-	-	-	*
h	Alarm 0 to 9 - Hours	0	0	23	hour	*
n	Alarm 0 to 9 - Minutes	0	0	59	min	*
---	Alarm 0 to 9 - Duration	0	0	999	min	*

HACCP HcP (HACCP Alarms)

Ht0	HACCP alarms present	0	0	1	-	NV
HAn	Number of type HA alarms	0	0	15	-	A
HA to HA2	Type HA HACCP alarms activated (press Set)	-	-	-	-	A
y	Alarm 1 to 3 - Year	0	0	99	year	*
M	Alarm 1 to 3 - Month	0	1	12	month	*
d	Alarm 1 to 3 - Day of the month	0	1	31	day	*
h	Alarm 1 to 3 - Hours	0	0	23	hour	*
n	Alarm 1 to 3 - Minutes	0	0	59	min	*
---	Alarm 1 to 3 - Duration	0	0	240	min	*
HFn	Number of type HF alarms	0	0	15	-	A
HF to HF2	Type HF HACCP alarms activated (press Set)	-	-	-	-	A
y	Alarm 1 to 3 - Year	0	0	99	year	*
M	Alarm 1 to 3 - Month	0	1	12	month	*
d	Alarm 1 to 3 - Day of the month	0	1	31	day	*
h	Alarm 1 to 3 - Hours	0	0	23	hour	*
n	Alarm 1 to 3 - Minutes	0	0	59	min	*
---	Alarm 1 to 3 - Duration	0	0	240	min	*
Htd	HACCP alarm delay 0 = monitoring disabled	0	0	240	min	A

🕒 rtc (Real Time Clock)

td1 to 8	Defrost 1 to 8 (press Set)	-	-	-	-	C
d	Defrost 1 to 8 - day 0 = event disabled 1 to 7 = Monday to Sunday 8 = Monday to Friday 9 = Monday to Saturday 10 = Saturday to Sunday 11 = every day	0	0	11	day	*
h	Defrost 1 to 8 - hours	0	0	23	hour	*
n	Defrost 1 to 8 - minutes	0	0	59	min	*
P	Defrost 1 to 8 - enable Power defrost 0 = normal; 1 = Power defrost	0	0	1	-	*
tS1 to 8	Start time band 1 to 8 day (press Set)	-	-	-	-	C
d	Start time band 1 to 8 day: day	0	0	11	day	*
h	Start time band 1 to 8 day: hours	0	0	23	hour	*
n	Start time band 1 to 8 day: minutes	0	0	59	min	*
tE1 to 8	End time band 1 to 8 day (press Set)	-	-	-	-	C
d	End time band 1 to 8 day: day	0	0	11	day	*
h	End time band 1 to 8 day: hours	0	0	23	hour	*
n	End time band 1 to 8 day: minutes	0	0	59	min	*
tc	Date/time (Press Set)	-	-	-	-	C
y	Date/time: year	0	0	99	year	*
M	Date/time: month	1	1	12	month	*
d	Date/time: day of the month	1	1	31	day	*
u	Date/time: day of the week	6	1	7	day	*
h	Date/time: hours	0	0	23	hour	*
n	Date/time: minutes	0	0	59	min	*

Tab. 8.a

9. ALARMS AND SIGNALS

9.1 Signals

The signals are messages shown on the display to notify the user of the control procedures in progress (e.g. defrost) or confirm the controls from the keypad or remote control.

Code	Icon	Description
---	-	Probe not enabled
dEF	☼	Defrost running
Ed1	-	Defrost on evaporator 1 ended by timeout
Ed2	-	Defrost on evaporator 2 ended by timeout
rct	-	Controller enabled for programming from the remote control
rcE	-	Controller disabled for the programming from the remote control
Add	-	Automatic address assignment in progress
ccb	-	Start continuous cycle call
ccE	-	End continuous cycle call
dFb	-	Start defrost call
dFE	-	End defrost call
On	-	Switch ON
OFF	-	Switch OFF
rES	-	Reset alarms with manual reset Reset HACCP alarms Reset temperature monitoring
AcE	-	Change from PI to ON/OFF control of anti-sweat heaters
Act	-	Control of Slaves serving Master via tLAN
Cn	-	Upload procedure in progress
uS	-	Slave unit not configured
205	-	Probe displayed faulty or not connected
Stb	-	Standby status
CLn	-	Clean status

Tab. 9.a

9.2 Alarms

There are two types of alarms:

- system: valve motor, EEPROM, communication, HACCP, high (HI and HI2) and low (LO and LO2) temperature alarms;
- control: low superheat (LowSH), low evaporation pressure (LOP), high evaporation pressure (MOP), low suction temperature (LSA).

The EE/EF data memory alarms shutdown the controller.

The auxiliary digital outputs AUX1 (relay 4), AUX2 (relay 5) and AUX3 (relay 2) can be configured to signal the alarm status, normally open or normally closed. See paragraph 5.4. The controller indicates alarms due to faults on the controller itself, on the probes or in network communication between the Master and Slaves. An alarm can also be activated from an external contact, immediate or delayed. See paragraph 5.2. The display shows "IA" and at the same time the alarm icon (triangle) flashes and the buzzer is activated. If more than one error occurs, these are displayed in sequence. A maximum of 10 errors can be saved, in a FIFO list (parameters HS0 to HS9). The last error saved can be read on parameter HS0 (see the table of parameters).

Example: display after HI error:

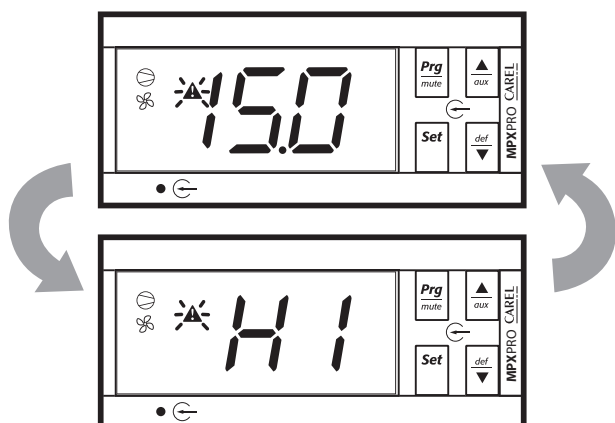

Fig. 9.a

Note:

- to deactivate the buzzer press Prg/mute;
- to cancel an alarm signal with manual reset, once the cause has been resolved, press Prg/mute and UP together for 5 seconds. The message rES will be shown as confirmation.

9.3 Display alarm log

Procedure:

- press Prg/mute and Set together for 5 seconds;
- enter the password: 44;
- press Set to access a submenu where the UP and DOWN buttons are used to scroll the various alarms, HS0 to HS9;
- select an alarm and press Set to display the code, hour, minutes and duration;
- from any of the child parameters, pressing Prg/mute returns to the parent parameter "HSx";
- press Prg/mute for 5 seconds to return to the standard display.

Example :

'HI' -> 'h17' -> 'm23' -> '65'

indicates that alarm 'HI' (high temperature alarm) was activated at 17:23 and lasted 65 minutes.



Note: alternatively, access the type A parameters and select category "HSt" = alarm log. See the table of parameters.

9.4 HACCP alarms and display

(HACCP = Hazard Analysis and Critical Control Point).

HACCP allows control of the operating temperature, recording any anomalies due to power failures or an increase in the temperature due to other causes (breakages, extreme operating conditions, user errors, etc.); see paragraph 9.6 for details.

Two types of HACCP event are managed:

- type HA alarms, high temperature during the operation;
- type HF alarms, high temperature after power failure (blackout).

When an alarm is recorded, the HACCP LED flashes, the display shows the alarm code, the alarm is saved and the alarm relay and buzzer are activated.

To display the HA and HF alarms:

- press Prg/mute and DOWN together;
- if on a Master unit, select the required network unit;
- scroll the list of alarms pressing UP and DOWN;
- press Set to select the required alarm;
- using UP or DOWN to see the description of the alarm: year, month, day, hours, minutes and duration in minutes of the selected alarm;
- press Prg/mute again to return to the previous list.

In addition, the HACCP alarm menu allows the following operations:

- delete an HACCP alarm by pressing Set & DOWN for 5 seconds when displaying the list of alarms. This causes the HACCP to flash, the display shows the message rES and the monitoring of HACCP alarms is reinitialised;
- delete the entire memory of HACCP alarms, by pressing Set & UP & DOWN for 5 seconds. This procedure displays the message rES, deletes the entire memory of alarms and reinitialises the monitoring of the HACCP alarms.

Table of alarms

Display code	Cause of the alarm	Icon flash on display	Alarm relay	Buzzer	Reset	Compressor	Defrost	Evaporator fans	Continuous cycle	Signalled on tLAN	Network solenoid valve
rE	Control probe fault		ON	ON	automatic	duty setting(c4)	unchanged	unchanged	unchanged	√	-
E1	Probe S1 fault		OFF	OFF	automatic	duty setting(c4)	unchanged	unchanged	unchanged	√	-
E2	Probe S2 fault		OFF	OFF	automatic	unchanged	unchanged	unchanged	unchanged	√	-
E3	Probe S3 fault		OFF	OFF	automatic	unchanged	unchanged	unchanged	unchanged	√	-
E4	Probe S4 fault		OFF	OFF	automatic	unchanged	unchanged	unchanged	unchanged	√	-
E5	Probe S5 fault		OFF	OFF	automatic	unchanged	unchanged	unchanged	unchanged	√	-
E6	Probe S6 fault		OFF	OFF	automatic	unchanged	unchanged	unchanged	unchanged	√	-
E7	Probe S7 fault		OFF	OFF	automatic	unchanged	unchanged	unchanged	unchanged	√	-
E8	Serial probe S8 not updated		OFF	OFF	automatic	duty setting(c4)	unchanged	unchanged	unchanged	√	-
E9	Serial probe S9 not updated		OFF	OFF	automatic	duty setting(c4)	unchanged	unchanged	unchanged	√	-
E10	Serial probe S10 not updated		OFF	OFF	automatic	duty setting(c4)	unchanged	unchanged	unchanged	√	-
E11	Serial probe S11 not updated		OFF	OFF	automatic	duty setting(c4)	unchanged	unchanged	unchanged	√	-
LO	Low temperature alarm		ON	ON	automatic	unchanged	unchanged	unchanged	unchanged	√	-
HI	High temperature alarm		ON	ON	automatic	unchanged	unchanged	unchanged	unchanged	√	-
LO2	Low temperature alarm		ON	ON	automatic	unchanged	unchanged	unchanged	unchanged	√	-
HI2	High temperature alarm		ON	ON	automatic	unchanged	unchanged	unchanged	unchanged	√	-
IA	Immediate alarm from external contact		ON	ON	automatic	duty setting(A6)	unchanged	unchanged	unchanged	√	-
dA	Delayed alarm from external contact		ON	ON	automatic	duty setting(A6) if A7≠0	unchanged	unchanged	unchanged	√	-
dor	Door open for too long alarm		ON	ON	automatic	unchanged	unchanged	unchanged	unchanged	√	-
Etc	Real time clock fault		OFF	OFF	automatic	unchanged	unchanged	unchanged	unchanged	√	-
LSH	Low superheat alarm		OFF	OFF	automatic	OFF	unchanged	unchanged	unchanged	√	√
LSA	Low suction temperature alarm		OFF	OFF	automatic / manual	OFF (paragraph 6.10)	unchanged	unchanged	unchanged	√	√
MOP	Maximum evaporation pressure alarm		OFF	OFF	automatic	OFF	unchanged	unchanged	unchanged	√	√
LOP	Low evaporation temperature alarm		OFF	OFF	automatic	unchanged	unchanged	unchanged	unchanged	√	√
bLo	Valve blocked alarm		OFF	OFF	manual/ disabled with P14=0	unchanged	unchanged	unchanged	unchanged	√	-
Edc	Communication error with stepper driver		ON	ON	automatic	unchanged	unchanged	unchanged	unchanged	√	-
EFS	Stepper motor broken/not connected		ON	ON	automatic	unchanged	unchanged	unchanged	unchanged	√	-
EE	Flash unit parameter error		OFF	OFF	automatic	OFF	not performed	OFF	not performed	√	-
EF	EEPROM operating parameter error		OFF	OFF	automatic	OFF	not performed	OFF	not performed	√	-
HA	Type HA HACCP alarm	HACCP	OFF	OFF	manual	unchanged	unchanged	unchanged	unchanged	√	-
HF	Type HF HACCP alarm	HACCP	OFF	OFF	manual	unchanged	unchanged	unchanged	unchanged	√	-
MA	Communication error with Master (only on Slave)		ON	ON	automatic	unchanged	unchanged	unchanged	unchanged	-	-
u1...u5	Communication error with Slave (only on Master)		ON	ON	automatic	unchanged	unchanged	unchanged	unchanged	-	-
n1...n5	Alarm on unit 1 to 5 in the network		ON	ON	automatic	unchanged	unchanged	unchanged	unchanged	-	-
up1...up5	Upload procedure with errors on unit 1 to 5		OFF	OFF	-	unchanged	unchanged	unchanged	unchanged	-	-
GPE	Error in custom gas parameters		ON	ON	automatic	OFF	not performed	OFF	not performed	√	-

Tab. 9.b

9.5 Alarm parameters

Assign probe for high and low temperature alarms (parameters AA, AA2)

AA selects the probe to be used for measuring the high and low temperature alarms with reference to thresholds AL and AH. AA2 is the same as AA for thresholds AL2 and AH2.

Par	Description	Def	Min	Max	UM
AA	Assign probe for high (AH) and low (AL) temperature alarms 1=control (Sreg) 2=virtual (Sv) 3=outlet (Sm) 4 = defrost (Sd) 5 = intake (Sr) 6 = gas surrisc. (tGS) 7 = saturated evap. temp. (tEu) 8 = auxiliary defrost (Sd2) 9 = auxiliary (Saux) 10 = auxiliary 2 (Saux2) 11 = ambient temp. (SA) 12 = amb. humidity (SU) 13 = glass temp. (Svt) 14 = dewpoint (SdP)	1	1	14	-
AA2	Assign probe for high (AH2) and low (AL2) temperature alarms - see AA	5	1	14	-

Tab. 9.c

Alarm parameters and activation

AL (AH) is used to determine the activation threshold for the low (high) temperature alarm LO (HI). The value set for AL (AH) is continuously compared against the value measured by the probe defined by parameter AA. Parameter Ad represents the alarm activation delay, in minutes; the low temperature alarm (LO) is activated only if the temperature remains below the value of AL for a time greater than Ad. The alarm may relative or absolute, depending on the value of parameter A1.

In the former case (A1=0), the value of AL indicates the deviation from the set point and thus the activation point for the low temperature alarm is: set point - AL. If the set point changes, the activation point also changes automatically. In the latter case (A1=1), the value of AL indicates the low temperature alarm threshold. The low temperature alarm active is signalled by the buzzer and code LO on the display.

The same applies to the high temperature alarm (HI), with AH instead of AL. The meaning of parameters AL2, AH2, AA2, A2 and Ad2 is similar to AL, AH, AA, A1 and Ad however relating to St2.

Par	Description	Def	Min	Max	UoM
AL	Low temperature alarm threshold If A1=0, AL=0: alarm disabled If A1=1, AL=-50: alarm disabled	4	-50.0	50.0	°C/°F
AH	High temperature alarm threshold If A1=0, AH=0: alarm disabled If A1=1, AH=50: alarm disabled	10	-50.0	50.0	°C/°F
AL2	Low temperature alarm 2 threshold If A2=0, AL2=0: alarm disabled If A2=1, AL2=-50: alarm disabled	0	-50.0	50.0	°C/°F
AH2	High temperature alarm 2 threshold If A2=0, AH2=0: alarm disabled If A2=1, AH2=50: alarm disabled	0	-50.0	50.0	°C/°F
A1	Alarm thresholds (AL, AH) relative to the set point St or absolute 0 = relative; 1 = absolute	0	0	1	-
A2	Alarm thresholds (AL2, AH2) relative to the set point St2 or absolute 0 = relative; 1 = absolute	0	0	1	-
A0	High and low temperature alarm reset differential	2.0	0.1	20.0	°C/°F
Ad	Delay time for high and low temperature alarms	120	0	240	min
Ad2	High and low temperature alarm delay (AL2, AH2)	120	0	240	min
A7	Delay time for delayed external alarm (AL, AH)	0	0	240	min
A6	Configure solenoid/compressor control during external alarm (immediate or delayed) with fixed 15 min OFF time 0 = always OFF; 100 = always ON	0	0	100	min

Tab. 9.d

Note:

- alarms LO(LO2) and HI(HI2) have automatic reset. A0 represents the hysteresis between the alarm activation value and deactivation value;
- if Prg/mute is pressed when the value measured is above one of the thresholds, the buzzer is immediately muted, while the alarm code and the alarm output, if set, remain active until the value measured is outside of the activation threshold. For delayed alarms from digital input (A4=3, code dA), the contact must remain open for a time greater than A7. In the case of an alarm event, a counter starts and generates an alarm when reaching the minimum time A7. If during the count the value measured returns within the threshold or the contact closes, the alarm is not signalled and the count is reset. When a new alarm condition occurs, the count starts from 0 again. Parameter A6 has a similar meaning to parameter c4 (duty setting). If an external alarm occurs (immediate or delayed) the compressor works for a time equal to the value set for A6 and remains off for a fixed time of 15 minutes.

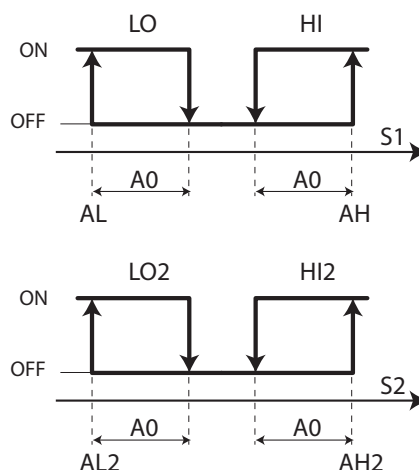

Fig. 9.b

Key

- LO, LO2 Low temperature alarms S1, S2 Probes
HI, HI2 High temperature alarms

Enable valve alarm at end travel ('blo')

Parameter P14 is used to enable/disable the valve blocked alarm signal ('blo').

Par.	Description	Def	Min	Max	UoM
P14	Enable valve alarm at end travel ('blo') 1 = signal enabled	1	0	1	-

Tab. 9.e

Signal alarms from Slave to Master

Master controllers, if Ar=1, can indicate a Slave with an alarm in the tLAN network. If an alarm occurs on a Slave, the Master shows the signal "nx", alternating with the temperature display, where x is the address of the Slave with the alarm (x=1 to 5). If the Master has the AUX1, AUX2 or AUX3 relay configured as the alarm relay, then the alarm relay on the Master is activated.

Par.	Description	Def	Min	Max	UoM
Ar	Signal alarms from Slave to Master 0 = not enabled; 1 = enabled	1	0	1	-

Tab. 9.f

Hot gas safety procedure for Slave offline (parameter A13)

In a Master/Slave network the multiplexed hot gas defrost is always synchronized by the Master. The safety procedure switches the Slave OFF if it is offline (no longer by the Master across the tLAN).

Par.	Description	Def	Min	Max	UoM
A13	Hot gas safety procedure for Slave offline 0 = not enabled; 1 = enabled	0	0	1	-

Tab. 9.g

Alarm log (parameters HS0 to HS9)

The alarm log can be displayed by accessing parameters HS0 to HS9, rather than using the procedure described in paragraph 9.3.

Par.	Description	Def	Min	Max	UoM
HS0 to 9	Alarm 0 to 9 (press Set)	-	-	-	-
---	Alarm 0 to 9 - Code	-	-	-	-
h	Alarm 0 to 9 - Hours	0	0	23	hour
n	Alarm 0 to 9 - Minutes	0	0	59	min
---	Alarm 0 to 9 - Duration	0	0	999	min

Tab. 9.h

9.6 HACCP alarm parameters and activating monitoring

Type HA alarms

The alarm queue can be displayed by accessing parameters HA to HA2, rather than using the procedure described in paragraph 9.4. The type HA alarm is generated if during normal operation the temperature read by the probe set for parameter AA exceeds the high temperature threshold for the time Ad+Htd. Consequently, compared to the normal high temperature alarm already signalled by the controller, the type HA HACCP alarm is delayed by a further time Htd specifically for HACCP recording. The order of alarms listed is progressive, HA is the most recent alarm. A maximum of 3 errors are saved, in a FIFO list (HA to HA2). HAN indicates the number of type HA alarms activated.

Par.	Description	Def	Min	Max	UoM
Ht0	HACCP alarms present	0	0	1	-
HAN	Number of type HA alarms	0	0	15	-
HA to HA2	Type HA HACCP alarms activated (press Set)	-	-	-	-
y	Alarm 1 to 3 - Year	0	0	99	year
M	Alarm 1 to 3 - Month	0	1	12	month
d	Alarm 1 to 3 - Day of the month	0	1	31	day
h	Alarm 1 to 3 - Hour	0	0	23	hour
n	Alarm 1 to 3 - Minutes	0	0	59	minute
---	Alarm 1 to 3 - Duration	0	0	240	minute
Htd	HACCP alarm delay 0 = monitoring disabled	0	0	240	

Tab. 9.i

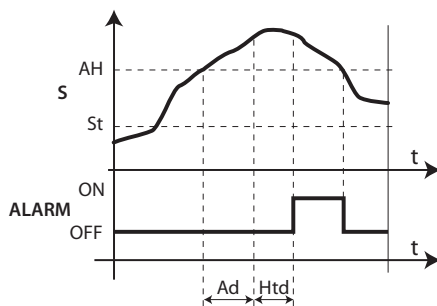

Fig. 9.c

Key

- S Measurement probe
- St Set point
- AH High temperature alarm threshold
- ALARM Type HA HACCP alarm
- Ad Delay time for high and low temperature alarms
- Htd HACCP alarm delay
- 0 = monitoring disabled
- t Time

Type HF alarms

The type HF HACCP alarm is generated following a power failure for an extended time (> 1 minute), if when power returns the temperature read by probe set for parameter AA exceeds the AH high temperature threshold. HFn indicates the number of type HF alarms activated.

Par.	Description	Def	Min	Max	UoM
HFn	Number of type HF alarms	0	0	15	-
HF to HF2	Type HF HACCP alarms activated (press Set)	-	-	-	-
y	Alarm 1 to 3 - Year	0	0	99	year
M	Alarm 1 to 3 - Month	0	1	12	month
d	Alarm 1 to 3 - Day of the month	0	1	31	day
h	Alarm 1 to 3 - Hours	0	0	23	hour
n	Alarm 1 to 3 - Minutes	0	0	59	minute
---	Alarm 1 to 3 - Duration	0	0	240	minute

Tab. 9.j

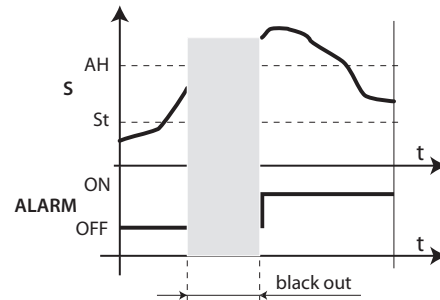

Fig. 9.d

Key

- S Measurement probe
- St Set point
- AH High temperature alarm threshold
- ALARM Type HF HACCP alarm
- t Time

10. TECHNICAL SPECIFICATIONS

	Model	Voltage	Power			
Power supply	MX3xxxxHxx	110-230 V~, 50/60 Hz	11.5 VA, 50 mA~ max			
	MX3xxxx(3,5,6)Hxx	110-230 V~, 50/60 Hz	23 VA, 115V~ (200 mA) 230V~ (100 mA) max			
Insulation guaranteed by the power supply	MXxxxx(E,A)xx	insulation from very low voltage parts	reinforced 6mm in air, 8mm on surface 3750 V insulation			
		insulation from relay outputs	primary 3mm in air, 4mm on surface 1250 V insulation			
Inputs	S1, S2 and S3	NTC (MXxxxx0xxx) or NTC, PTC, PT1000 and NTC L243 (MXxxxx(1,2,3,4,5,6,7,8)xxx)				
	S4/DI1, S5/DI2	NTC (MXxxxx0xxx) or NTC, PTC, PT1000 and NTC L243 (MXxxxx(1,2,3,4,5,6,7,8)xxx) voltage-free contact, contact resistance < 10 Ω, closing current 6 mA				
	S6/ DI3	NTC (MXxxxx0xxx) or NTC, PTC, PT1000 and NTC L243 (MXxxxx(1,2,3,4,5,6,7,8)xxx) 0 to 5 V ratiometric (MXxxxxxxx) voltage-free contact, contact resistance < 10 Ω, closing current 6 mA				
	S7/DI4	NTC (MXxxxx0xxx) or NTC, PTC, PT1000 and NTC L243 (MXxxxx(1,2,3,4,5,6,7,8)xxx) 0 to 5 V ratiometric (MXxxxxxxx), 4 to 20 mA, 0...10 V (MXxxxx(1,2,3,4,5,6,7,8)xxx) voltage-free contact, contact resistance < 10 Ω, closing current 6 mA				
	DI5	voltage-free contact, contact resistance < 10 Ω, closing current 6 mA				
Maximum distance between probes and digital inputs less than 10 m. Note: in the installation it is recommended to separate the power and load connections from the probe, digital input, display and supervisor cables.						
Probe type	Std. CAREL NTC	10 kΩ at 25 °C, range from -50 °C to +90 °C	measurement error 1 °C in range from -50 °C to +50 °C; 3 °C in range from +50 °C to +90 °C			
	Std. CAREL PTC (specific model)	985 Ω at 25 °C, range from -50 °C to 150 °C	2 °C in range from -50 °C to +50 °C; 4 °C in range from +50 °C to +150 °C			
	Pt 1000	1000Ω at 0 °C, range from -50 °C to +90 °C	measurement error 1 °C in range from -50 °C to +50 °C; 3 °C in range from +50 °C to +90 °C			
	NTC L243	2000 Ω at 0 °C, range from -50 °C to 90 °C	measurement error 2 °C in range from -50 °C to +25 °C			
	0 to 5 V ratiometric	resolution 0.1 % fs	measurement error 2 % fs maximum; 1 % typical			
	4 to 20 mA	resolution 0.5 % fs	measurement error 8 % fs maximum; 7 % typical			
	0 to 10 V	resolution 0.1 % fs	measurement error 9 % fs maximum; 8 % typical			
		according to the model				
Relay outputs		EN60730-1	operating cycles	UL	operating cycles	
	relay	250 V~		250 V~		
	R1, R5, R4	6 (4) A on N.O. 6 (4) A on N.C. 2 (2) A on N.O. and N.C.	100000	6 A res 240 Vac N.O. / N.C. 1/2 Hp 240 Vac N.O. 1/6 Hp 120 Vac N.O.	30000	
	R3	10 (2) A su N.O.	100000	10 A res 240 Vac	30000	
	R2	10 (10) A	100000	10 A res 1Hp 240/120 Vac N.O.	6000	
insulation from very low voltage parts		reinforced 6mm in air, 8mm on surface 3750V insulation				
insulation between independent relay outputs		primary 3mm in air, 4mm on surface 1250 V insulation				
Analogue outputs PWM 1, 2	Model MXxxx(2, 3)xxxx	Output voltage, maximum current available (not isolated from board earth) 12 Vdc, 20 mA max for each PWM				
Connections	Type of connections			Cross-section	Maximum current	
	model	relay	power supply	probes	for cables from 0.5 to 2.5 mm ²	12 A
	MXxxxxx(A,G,M)x	screw 180°	screw 180°	screw 180°		
MXxxxxx(C,I,O)x	plug-in 180°	plug-in 180°	plug-in 180°			
The correct sizing of the power cables and the connections between the instrument and the loads is the installer's responsibility.						
Clock	error at 25 °C			± 10 ppm (±5.3 min/year)		
	error in the temp. range -10T60 °C			- 50 ppm (-27 min/year)		
	ageing			< ±5 ppm (±2.7 min/year)		
	Discharge time			6 months typical (8 months maximum)		
	Recharge time			5 hours typical (< 8 hours maximum)		
Operating temperature	MXxxxxx(A,B,C,G,I): -10T60 °C			MXxxxxx(M,N,O): -10T50 °C		
Index of protection	IP00					
Operating humidity	<90% RH non-condensing					
Storage temperature	-20T70 °C					
Storage humidity	<90% RH non-condensing					
Environmental pollution	2 (normal)					
PTI of the insulating materials	printed circuits 250, plastic and insulating materials 175					
Period of stress across the insulating parts	long					
Category of resistance to fire	category D					
Class of protection against voltage surges	category III					
Type of action and disconnection	1C relay contacts (microswitching)					
Construction of the control device	integrated electronic control device					
Classification according to protection against electric shock	Class 2 when suitably integrated					
Device designed to be hand-held or integrated into equipment designed to be hand-held	no					
Software class and structure	Class A					
Cleaning the front panel of the instrument	only use neutral detergents and water					
Main and secondary display	External					
Maximum distance between controller and display	up to 10 m with shielded cable AWG22 (power supply, rx-tx, gnd)					
	up to 100 mt (only one terminal can be connected) with shielded cable AWG20 (power supply, rx-tx, gnd)					
LAN connection	up to 100 m total, with shielded cable AWG20 (rx-tx, gnd);					
Serial communication (master only)	RS485, CAREL and Modbus® protocols (auto-recognized), 19200 bps, 8 data bits, no parity, 2 stop bits					
Programming key	available on all models					

Tab. 10.a

EN13485:2003: The MPXPRO range fitted with the standard CAREL NTC probes model NTC015WF00, NTC030HF01 and NTC015HP00 is compliant with standard EN 13485 on thermometers for measuring the air and product temperature for the transport, storage and distribution of chilled, frozen, deep-frozen/quick-frozen food and ice cream. Designation of the instrument: EN13485, air, S, 1, -50T90°C. The standard CAREL NTC probe is identifiable by the printed laser code on "WF", "HF" models, or the code "103AT-11" on "HP" models, both visible on the sensor part.

10.1 Cleaning the terminal

When cleaning the terminal do not use ethyl alcohol, hydrocarbons (petrol), ammonia and derivatives. Use neutral detergents and water.

10.2 Purchase codes

code	description
MX10M00E11	MPXPRO light: (with RS485 e RTC) Master 5 relay, no EEV, 230 Vac, multiple package 20 pcs, no connectors kit
MX10S00E11	MPXPRO light: Slave 5 relay, no EEV, 230 Vac, multiple package 20pcs, no connectors kit
MX10S10E11	MPXPRO light: Slave 3 relay, no EEV, 230 Vac, multiple package 20pcs, no connectors kit
MX30M21H00	MPXPRO: complete controller (with RS485 e RTC) Master 5 relay, 115-230 Vac, 2 PWM, NTC/Pt1000, connectors kit with horizontal screws
MX30S21H00	MPXPRO: complete controller Slave 5 relay, 115-230 Vac, 2 PWM, NTC/Pt1000, connectors kit with horizontal screws
MX30S31H00	MPXPRO: complete controller Slave 3 relay, 115-230 Vac, 2 PWM, NTC/Pt1000, connectors kit with horizontal screws
MX30M25H00	MPXPRO: complete controller with E2V management (with RS485 e RTC) Master 5 relay, 115-230 Vac, E2V Stepper & Ultracap, 2 PWM, 0 to 10 Vdc, NTC/Pt1000, connectors kit with horizontal screws
MX30S25H00	MPXPRO: complete controller with E2V management Slave 5 relay, 115-230 Vac, E2V Stepper & Ultracap, 2 PWM, 0 to 10 Vdc, NTC/Pt1000, connectors kit with horizontal screws
MX30M24H00	MPXPRO: complete controller with EEV management (with RS485 e RTC) Master 5 relay, 115-230 Vac, E2V PWM, 2 PWM, 0 to 10 Vdc, NTC/Pt1000, connectors kit with horizontal screws
MX30S24H00	MPXPRO: complete controller with EEV management Slave 5 relay, 115-230 Vac, E2V PWM, 2 PWM, 0 to 10 Vdc, NTC/Pt1000, connectors kit with horizontal screws
MX30M21HR0	MPXPRO: complete controller (with RS485 e RTC) Master 5 relay, 115-230 Vac, 2 PWM, NTC/Pt1000, connectors kit with vertical screws
MX30S21HR0	MPXPRO: complete controller Slave 5 relay, 115-230 Vac, 2 PWM, NTC/Pt1000, connectors kit with vertical screws
MX30S31HR0	MPXPRO: complete controller Slave 3 relay, 115-230 Vac, 2 PWM, NTC/Pt1000, connectors kit with vertical screws
MX30M25HR0	MPXPRO: complete controller with E2V management (with RS485 e RTC) Master 5 relay, 115-230 Vac, E2V Stepper & Ultracap, 2 PWM, 0 to 10 Vdc, NTC/Pt1000, connectors kit with vertical screws
MX30S25HR0	MPXPRO: complete controller with E2V management Slave 5 relay, 115-230 Vac, E2V Stepper & Ultracap, 2 PWM, 0 to 10 Vdc, NTC/Pt1000, connectors kit with vertical screws
MX30M24HR0	MPXPRO: complete controller with EEV management (with RS485 e RTC) Master 5 relay, 115-230 Vac, E2V PWM, 2 PWM, 0 to 10 Vdc, NTC/Pt1000, connectors kit with vertical screws
MX30S24HR0	MPXPRO: complete controller with EEV management Slave 5 relay, 115-230 Vac, E2V PWM, 2 PWM, 0 to 10 Vdc, NTC/Pt1000, connectors kit with vertical screws
MX30M25HO01	MPXPRO: complete controller with E2V management (with RS485 e RTC) Master 5 relay, 115-230 Vac, E2V Stepper & Ultracap, 2 PWM, 0 to 10 Vdc, NTC/Pt1000, multiple package 20 pcs, no connectors kit
MX30S25HO01	MPXPRO: complete controller with E2V management Slave 5 relay, 115-230 Vac, E2V Stepper & Ultracap, 2 PWM, 0 to 10 Vdc, NTC/Pt1000, multiple package 20 pcs, no connectors kit
MX30M24HO01	MPXPRO: complete controller with EEV management (with RS485 e RTC) Master 5 relay, 115-230 Vac, E2V PWM, 2 PWM, 0 to 10 Vdc, NTC/Pt1000, multiple package 20 pcs, no connectors kit
MX30S24HO01	MPXPRO: complete controller with EEV management Slave 5 relay, 115-230 Vac, E2V PWM, 2 PWM, 0 to 10 Vdc, NTC/Pt1000, multiple package 20 pcs, no connectors kit
IR00UG6300	Terminal (green LEDs, keypad)
IR00UGC300	Terminal (green LEDs, keypad, buzzer, commissioning port, IR)
IR00XG6300	Display (green LEDs)
IR00XGC300	Display (green LEDs, keypad, buzzer, commissioning port, IR)
IR00XGP300	Resinated display (Green LED, IP65, cavo l= 5 m)
MX30PSTH02	MPXPRO option, E2V stepper & ultracap module+ 0 to 10 Vdc, connectors kit with horizontal screws
MX30PSTH03	MPXPRO option, E2V stepper & ultracap module+ 0 to 10 Vdc, connectors kit with vertical screws
MX30PPWM02	MPXPRO option, EEV PWM + 0 to 10 Vdc module, connectors kit with horizontal screws
MX30PPWM03	MPXPRO option, EEV PWM + 0 to 10 Vdc module, connectors kit with vertical screws
MX*OPA10**	MPXPRO option, analog module 0 to 10 V, connectors kit
MX30P48500	MPXPRO option RS485 + RTC (not necessary on master codes)
MXOPZKEYA0	Programming key MPXPRO (230 Vac)
IRTRMPX000	IR remote control for MPXPRO
CVSTDUMORO	USB/RS485 converter
MX3COB5R01	Silk screened connectors kit for 5 relay main board with horizontal screws
MX3COB3R01	Silk screened connectors kit for 3 relay main board with horizontal screws
MX3COSTH01	Silk screened connectors kit for E2V stepper driver module with horizontal screws
MX3COPWM01	Silk screened connectors kit for PWM driver option with horizontal screws
MX3CDB5R01	Neutral connectors kit for 5 relay main board with vertical screws
MX3CDB3R01	Neutral connectors kit for 3 relay main board with vertical screws
MX3CDSTH01	Neutral connectors kit for E2V stepper driver module with vertical screws
MX3CDPWM01	Neutral connectors kit for PWM driver module with vertical screws
MX3CRA1041	Connectors kit 0 to 10 Vdc analog module

Tab. 10.b

Examples

application	no.	code	description
showcase	Master	1	MX30M25H00 MPXPRO: complete Master controller with EEV management (including RS485 and RTC) 5 relays + Stepper EEV, 2 PWM, 0 to 10 Vdc, NTC/PT1000, horizontal screw connector kit
		1	IR00UGC300 Terminal (green LEDs, keypad, buzzer, commissioning port, IR)
		3	NTC0*0HP00 NTC probe, IP67, cable l= *, -50T50 °C
		1	NTC0*0HF01 NTC probe, IP67, cable l= * m, -50T90 °C STRAP-ON, multiple package (10 pcs.)
		1	SPKT0013R0 Ratiometric pressure probes for MPXPRO: ratiometric pressure transducer with 1/4" SAE steel female connector, 7/16" -20 UNF -2B, PACKARD connector (single package), 0 to 5 Vdc, -1 to 9.3 bar (0 to 150 psiA)
		1	SPKC00*310 Ratiometric pressure probes for MPXPRO: ratiometric pressure transducer with 1/4" SAE steel female connector, 7/16" -20 UNF -2B, PACKARD connector (single package), IP67, cable l= * m with co-moulded PACKARD connector for SPKT*
		1	E2V**BSF00 EEV with 12 mm copper fittings, sizes from 9 to 24
		1	E2VCABS600 Shielded cable with connector for EEV, l= 6 m

application		no.	code	description
showcase	Slave	1	MX30S25HO0	MPXPRO: complete Slave controller 5 relays + Stepper EEV, 2 PWM, 0 to 10 Vdc, NTC/PT1000, horizontal screw connector kit
		1	IR00XGC300	Display (green LEDs, keypad, buzzer, commissioning port, IR)
		3	NTC0*OHP00	NTC probe, IP67, cable l= * m, -50T50 °C
		1	NTC0*OHF01	NTC probe, IP67, cable l= * m, -50T90 °C STRAP-ON, multiple package (10 pcs.)
		1	E2V**BSF00	EEV with 12 mm copper fittings, sizes from 9 to 24
		1	E2VCABS600	Shielded cable with connector for EEV, l= 6 m
cold room	Master only	1	MX30M25HO0	MPXPRO: complete Master controller with EEV management (including RS485 and RTC) 5 relays + Stepper EEV, 2 PWM, 0 to 10 Vdc, NTC/PT1000, horizontal screw connector kit
		1	IR00UGC300	Terminal (green LEDs, keypad)
		2/3	NTC0*OHP00	NTC probe, IP67, cable l= * m, -50T50 °C
		1	NTC0*OHF01	NTC probe, IP67, cable l= * m, -50T90 °C STRAP-ON, multiple package (10 pcs.)
		1	SPKT0013R0	Ratiometric pressure probes for MPXPRO: ratiometric pressure transducer with 1/4" SAE steel female connector, 7/16" -20 UNF -2B, PACKARD connector (single package), 0 to 5 Vdc, -1 to 9.3 bar (0 to 150 psiA)
		1	SPKC00*310	Ratiometric pressure probes for MPXPRO: ratiometric pressure transducer with 1/4" SAE steel female connector, 7/16" -20 UNF -2B, PACKARD connector (single package), IP67, cable l= * m with co-moulded PACKARD connector for SPKT*
		1	E2V**BSF00	EEV with 12 mm copper fittings, sizes from 9 to 24
		1	E2VCABS600	Shielded cable with connector for EEV, l= 6 m

Tab. 10.c

10.3 Food safety - HACCP

This instrument makes a significant contribution to ensuring optimum preservation of foodstuffs that need to be stored at controlled temperatures. The following suggestions will allow the device to be used in the best possible way and ensure the desired features over time.

Local standards may specify additional requirements, national certification or more rigorous documentation to be completed and kept on file. In case of doubt, contact the food safety manager or site manager.

Sensors - installation

Temperature sensors are fundamental components of the measuring system. Make sure these are checked periodically, in accordance with the application. When temperature measurement is significant for food safety, only use the temperature probes suggested by Carel for food storage applications.



All Carel NTC probes are approved in accordance with:
HACCP International Food Safety Certification Systems
 for application in **FZS (Food Zone Secondary)**
 Models NTC*INF* **FZP (Food Zone Primary)**
 Models NTC*PS* **SSZ (Splash or Spill Zone)**
 (Excluding only NTC*HT*, specific models for high temperatures)

Parameters

Modification of parameters that affect temperature measurement and display may not be allowed in certain applications, or alternatively may require specific authorisation. Any modifications made must be noted on the relevant documents (refer to HACCP procedures, where envisaged). In case of doubt, contact the food safety manager or site manager.

Repairs and maintenance

All significant maintenance operations generally require a new "periodic verification" to be carried out, in order to confirm that the device's operating specifications are still within the limits required by the application.

We recommend that written documents be kept on the operations performed, clearly identifying:

- the instrument in question (e.g.: part number, serial number);
- the unit it is used on (e.g.: meat cold room no. 3, cheese showcase no. 7...);
- the reasons why maintenance was needed;
- any actions performed to restore functionality;
- the checks carried out, with reference to the procedures adopted;
- identification of the primary measuring instruments used (e.g.: thermometer model, serial number, calibration certificate no. xxx issued by laboratory yyy);
- identification of the operator (qualified) responsible for verification and confirmation;
- explicit confirmation of instrument validity until the next periodic verification.

or

- if the minimum specifications for use are no longer met, the instrument must be downgraded, repaired or replaced and taken out of service.



Important: local standards or system characteristics frequently require application of HACCP procedures (Hazard Analysis and Critical Control Points). Such procedures should be defined and managed by suitably trained personnel.

CAREL

CAREL INDUSTRIES - Headquarters

Via dell'Industria, 11 - 35020 Brugine - Padova (Italy)

Tel. (+39) 049.9716611 - Fax (+39) 049.9716600

e-mail: carel@carel.com - www.carel.com

Agenzia / Agency: