

Installation guide

Thermostat

KP 61 – KP 85

060R9758

060R9758

KP 61, KP 62, KP 63, KP 68, KP 69 vapour charge
KP 62, KP 71, KP 73, KP 75, KP 77, KP 78, KP 79, KP 81, KP 85 adsorption charge (cross ambient)

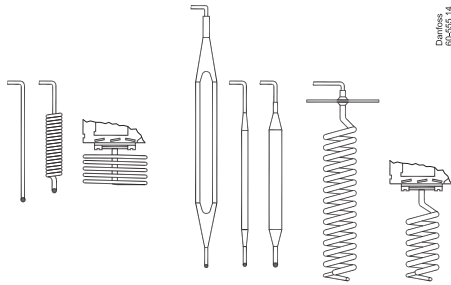
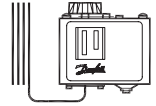

Vapour charge Adsorption charge

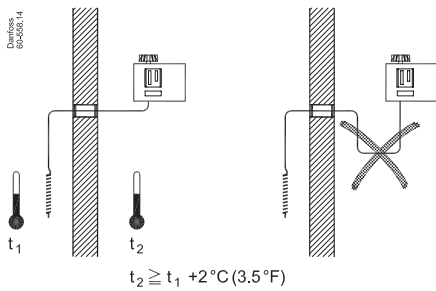
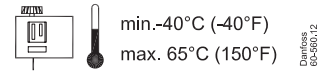
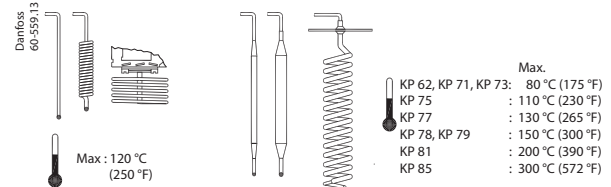

Vapour charge

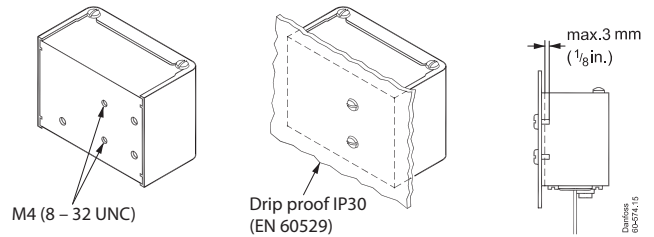
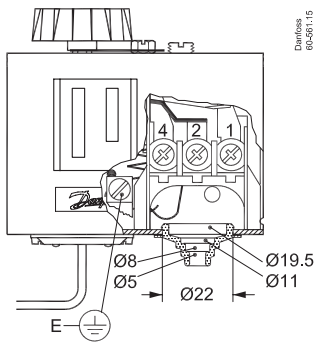
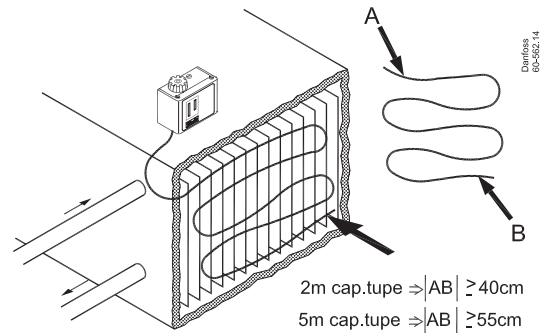

Electrical rating - General

LR 112A	AC 1: 16A	400 V	DC 11
	AC 3: 16A		12 W
	AC 15: 10 A		220 V

When used acc. to UL regulations

UL US LISTED Listed refrigeration controller 61B5

Voltage	FL	LR	Resist. load	Pilot duty
AC DC	A	A		
240	8	48	8 A	3 A
120	16	96	16 A	
	240			12 W

Use copper wire only
 Tightening torque 20 lb.in.

* not applying for KP 85



CAUTION:

Disconnect power supply before wiring connections are made or service to avoid possible electrical shock or damage to equipment.

Do never touch live parts with your fingers or with any tool.

Manual trip function

Automatic reset

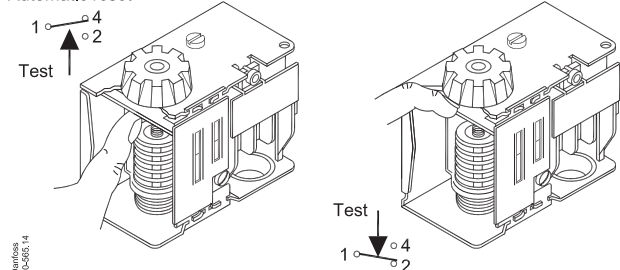

Danfoss
60-433.14

Manual reset

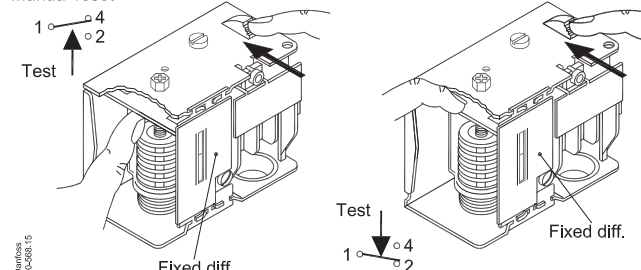

Danfoss
60-285.15

KP 61	060L110466, 060L110566
KP 71	060L111566
KP 73	060L113866

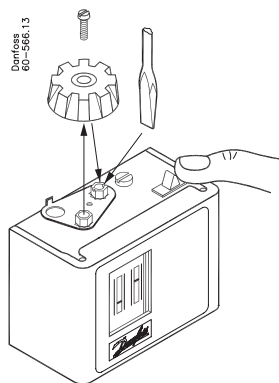

Danfoss
60-566.13

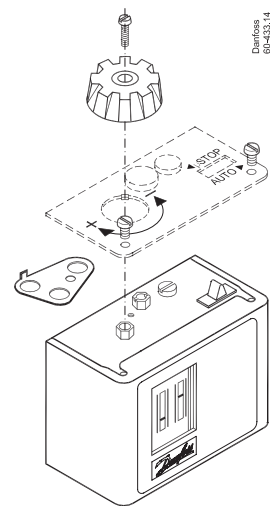

Danfoss
60-433.14

Vapour charge

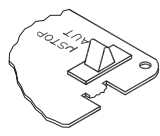
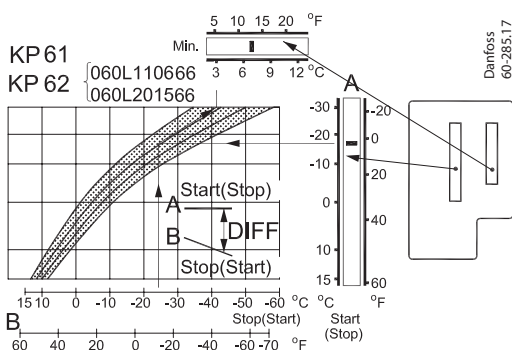

KP 61	060L110366 060L112866	Vapour charge
KP 62	060L111066	Adsorption charge
KP 73	060L111866	charge

