

WiSAN-YME 1 S 2.1-14.1



Summary

1.	Power range and furniture	5
1.1	Power	5
1.2	Furniture	5
2.	Layout of components	6
2.1	Sizes 2.1 - 3.1	6
2.2	Sizes 4.1 - 5.1	7
2.3	Sizes 6.1T - 7.1T - 8.1T	8
2.4	Sizes 9.1 - 10.1 - 12.1 - 14.1	9
3.	Refrigeration circuit	10
3.1	Refrigerant circuit diagram	10
3.2	Heating and Domestic Hot Water operation	12
3.3	Cooling and defrosting operation	12
4.	Control	13
4.1	Stop	13
4.2	Standby	13
4.3	Startup control	13
4.4	Startup in heating and domestic hot water mode	16
4.5	Startup in cooling mode	16
4.6	Normal operation	17
4.7	Protection control	19
4.8	Special controls	23
5.	Layout of electrical panel	31
5.1	Sizes 2.1 - 3.1	31
5.2	Sizes 4.1 - 5.1	31
5.3	Sizes 6.1 - 7.1 - 8.1	32
5.4	Sizes 6.1T - 7.1T - 8.1T	32
5.5	Sizes 9.1 - 10.1 - 12.1 - 14.1	33
6.	Layout of PCB boards	34
6.1	Water circuit board 2.1 - 14.1	34
6.2	Refrigerant circuit board - 2.1 - 3.1 - 4.1 - 5.1	36
6.3	Refrigerant circuit module 6.1 - 7.1 - 8.1 single-phase	38
6.4	Refrigerant circuit module 6.1T - 7.1T - 8.1T	40
6.5	Refrigerant circuit module 9.1 - 10.1 - 12.1 - 14.1	42
6.6	Inverter module - 2.1 - 3.1	44
6.7	Inverter module - 4.1 - 5.1	45
6.8	Inverter module - 6.1 - 7.1 - 8.1 single-phase	46
6.9	Inverter module - 6.1T - 7.1T - 8.1T	47
6.10	Inverter module - 9.1 - 10.1 - 12.1 - 14.1	48
6.11	Filter module 6.1T - 7.1T - 8.1T	49
6.12	Filter module - 9.1 - 10.1 - 12.1 - 14.1	50
6.13	Display	51
6.14	DIP Switch setting	51
7.	Table of error codes	53
8.	Troubleshooting	55
9.	Temperature sensor resistance characteristics	114

1. Power range and furniture

1.1 Power



1.1.1 Single-phase unit

Size	2.1	3.1	4.1	5.1	6.1	7.1
Capacity Kw	4	6	8	10	12	14

1.1.2 Three-phase unit

Size	6.1	7.1	8.1	9.1	10.1	12.1	14.1
Capacity Kw	12	14	16	18	22	26	30

1.2 Furniture

2.1 - 3.1	4.1 - 8.1	9.1 - 14.1
		

2. Layout of components

2.1 Sizes 2.1 - 3.1

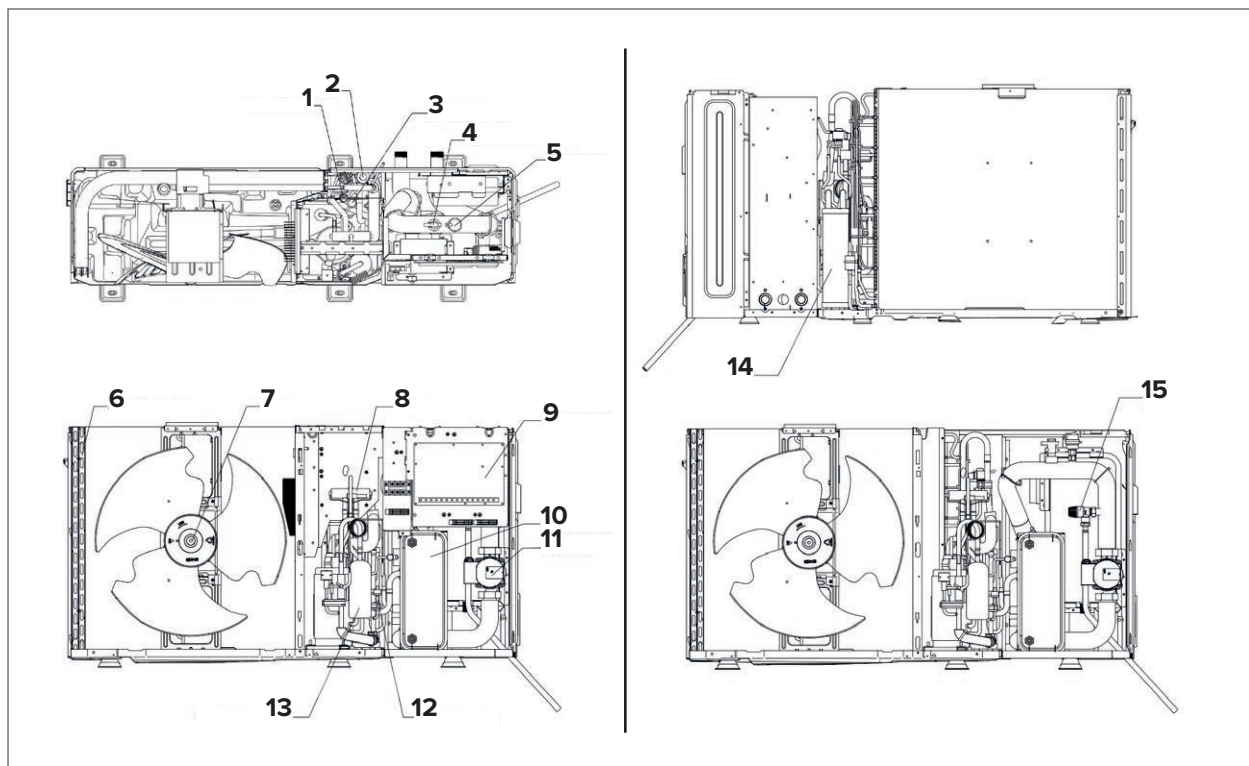

N°	Component
1	Pressure sensor
2	Electronic expansion valve
3	High pressure switch
4	Water flow switch
5	Air relief valve
6	Source exchanger: finned coil
7	Fan
8	4-way valve
9	Main board
10	Water side heat exchanger
11	Water circulator
12	Low pressure switch
13	Compressor inverter
14	Gas-suction separator
15	Water pressure relief valve

LAYOUT OF COMPONENTS

2.2 **Sizes 4.1 - 5.1**

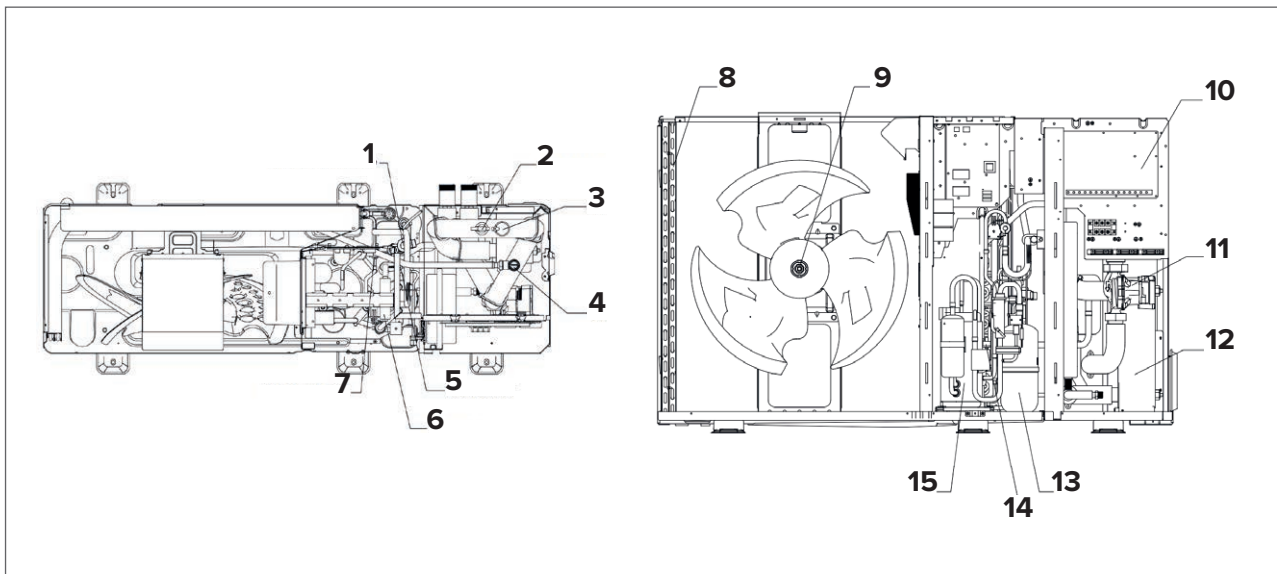

N°	Component
1	Electronic expansion valve
2	Water flow switch
3	Air relief valve
4	Water pressure relief valve
5	Pressure sensor
6	4-way valve
7	High pressure switch
8	Source exchanger: Finned coil
9	Fan motor
10	Main board
11	Water circulator
12	Water side heat exchanger
13	Gas-suction separator
14	Low pressure switch
15	Compressor inverter

LAYOUT OF COMPONENTS

2.3 **Sizes 6.1T - 7.1T - 8.1T**

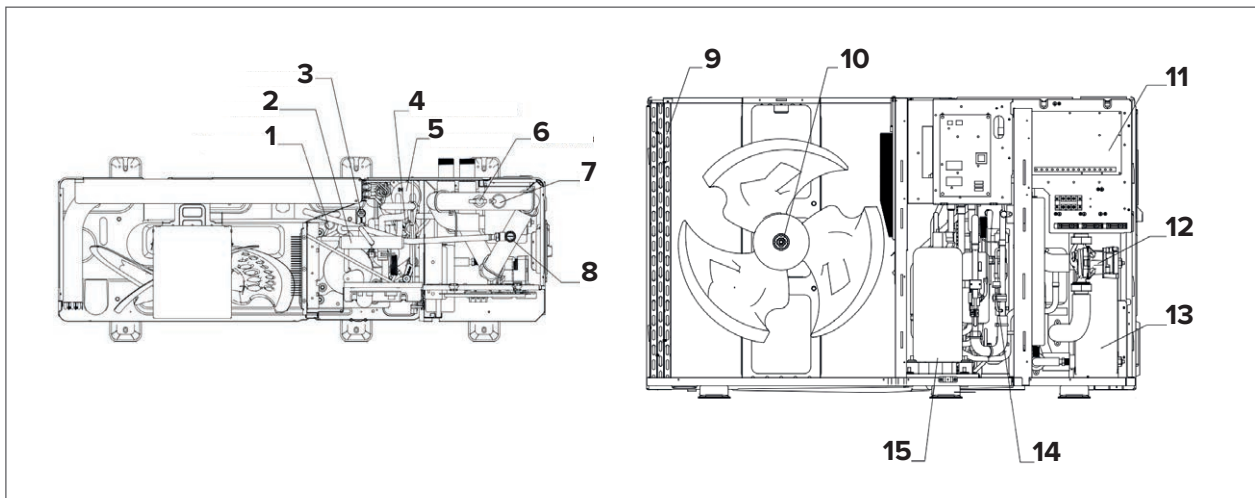

N°	Component
1	High pressure switch
2	4-way valve
3	Pressure sensor
4	Electronic expansion valve
5	Gas-suction separator
6	Water flow switch
7	Air relief valve
8	Water pressure relief valve
9	Source exchanger: Finned coil
10	Fan motor
11	Main board
12	Water circulator
13	Water side heat exchanger
14	Low pressure switch
15	Compressor inverter

LAYOUT OF COMPONENTS

2.4 **Sizes 9.1 - 10.1 - 12.1 - 14.1**

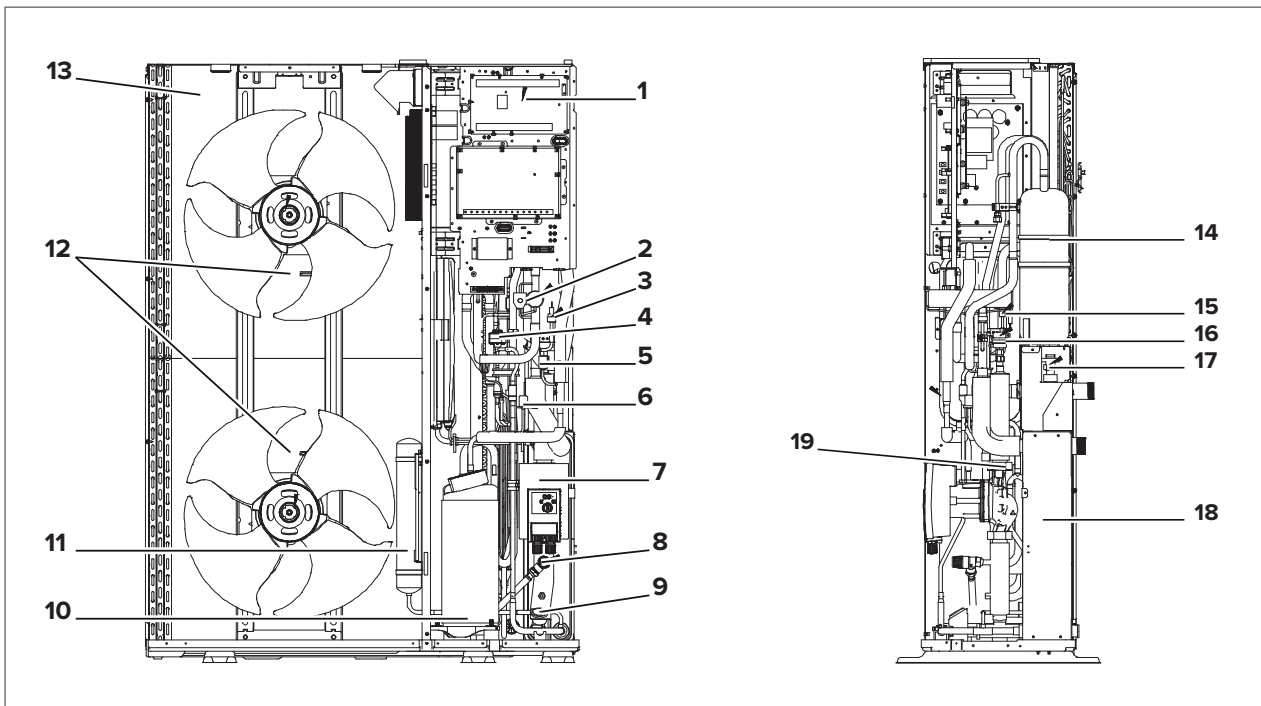

N°	Component
1	Main board
2	4-way valve
3	Pressure sensor
4	Electronic expansion valve
5	High pressure switch
6	Low pressure switch
7	Water circulator
8	Water pressure relief valve
9	Pressure gauge
10	Compressor inverter
11	Gas-suction separator
12	Fan motor
13	Source exchanger: Finned coil
14	Liquid receiver
15	Non return valve
16	Air relief valve
17	Water flow switch
18	Water side heat exchanger
19	Expansion vessel

3. Refrigeration circuit

3.1 Refrigerant circuit diagram

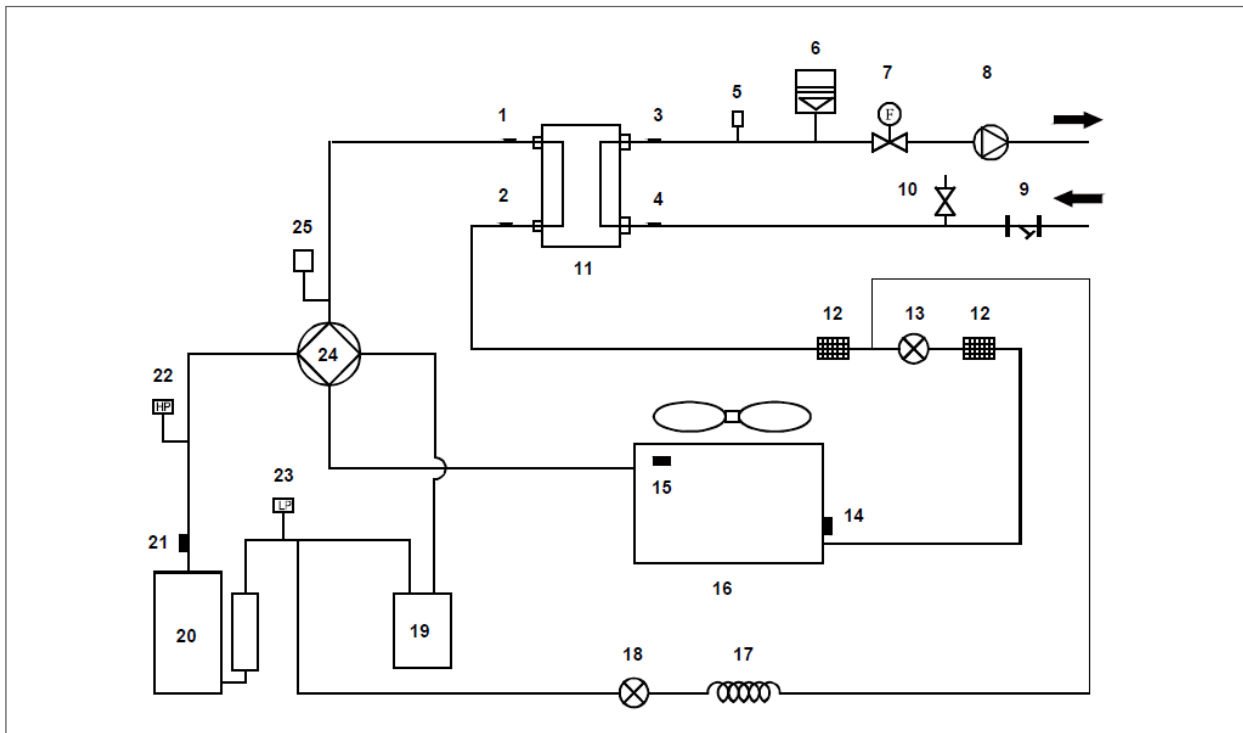

1	Refrigerant temperature sensor - gas line	13	Electronic expansion valve
2	Refrigerant temperature sensor - liquid line	14	Evaporation (cooling) / condensing (heating) sensor
3	Water outlet temperature sensor	15	Outdoor temperature sensor
4	Water inlet temperature sensor	16	Air side exchanger
5	Automatic vent	17	Capillary
6	Expansion vessel	18	Solenoid valve
7	Flow switch	19	Suction separator
8	Circulator	20	Compressor
9	Y filter	21	Discharge temperature sensor
10	Safety valve	22	HP-pressure switch
11	Water side exchanger	23	LP-pressure switch
12	Filter	24	4-way valve
		25	Pressure sensor

REFRIGERATION CIRCUIT

3.1.1 Main components:

Separator:

separates refrigerant liquid from refrigerant gas to protect compressor from liquid hammering.

Electronic expansion valve (EXV):

controls refrigerant flow and reduces refrigerant pressure.

4-way valve:

controls refrigerant flow direction.

Closed in cooling mode and open in heating mode.

When closed, the air side exchanger functions as a condenser and water side exchanger functions as an evaporator.

When open, the air side exchanger functions as an evaporator and water side exchanger functions as a condenser.

High and low pressure switches:

control refrigerant system pressure.

When refrigerant system pressure rises above the upper limit or falls below the lower limit, the high or low pressure switches turn off, stopping the compressor

Air purge valve:

Automatically removes air from the water circuit.

Pressure relief valve:

prevents excessive water pressure by opening at 3 bar and discharging the water from the water circuit.

Expansion vessel:

Balances the water system pressure. (Expansion vessel volume: 4.8L)

Water flow switch:

Detects the water flow rate to protect the compressor and water pump if the water flow rate is insufficient.

Backup electric heater:

Not provided with the standard version (Provided as an option with direct shipping)

Provides additional heating capacity when the heat pump's heating capacity is insufficient due to low outdoor temperature.

Also protects external water piping from frost.

Water pump:

circulates water in the water circuit.

3.2 Heating and Domestic Hot Water operation

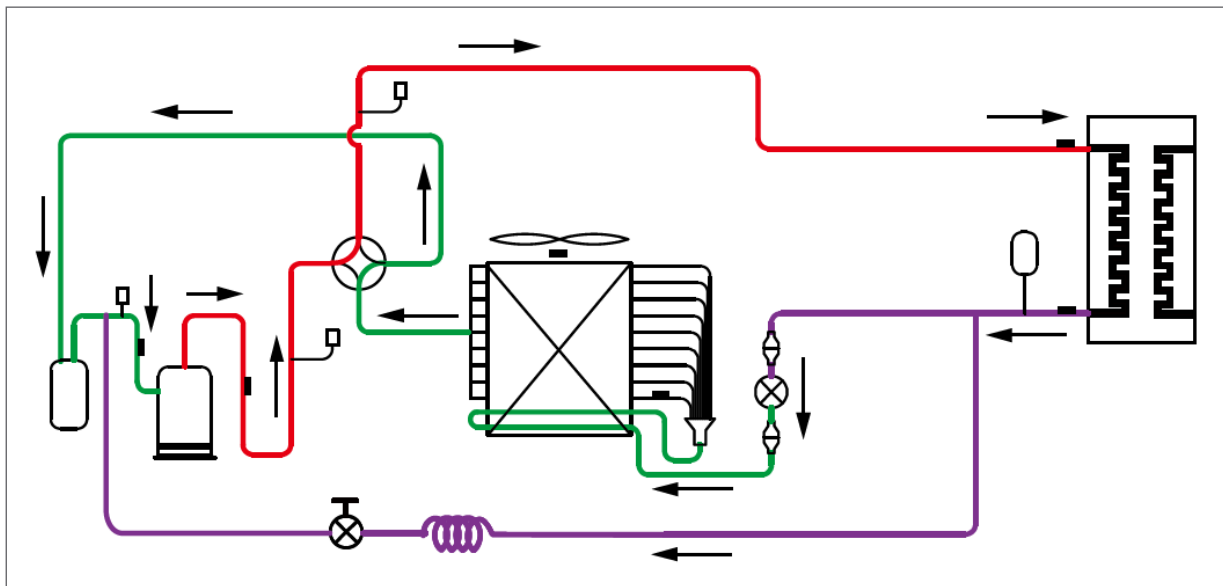

Red	High temperature, high pressure, gas
Green	Low temperature, low pressure
Viola	High temperature, high pressure, liquid

3.3 Cooling and defrosting operation

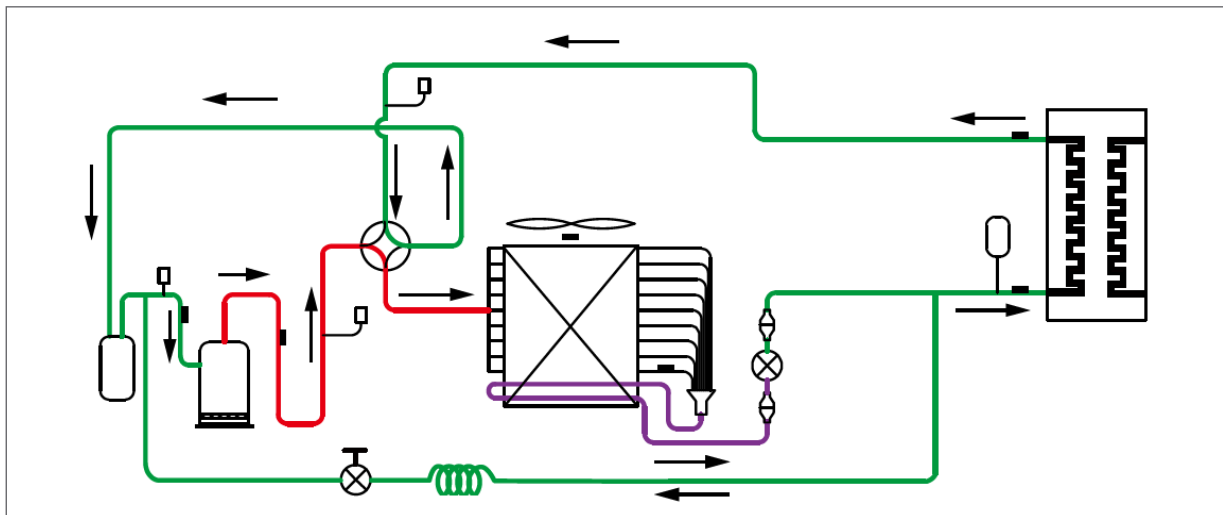

Red	High temperature, high pressure, gas
Green	Low temperature, low pressure
Viola	High temperature, high pressure, liquid

CONTROL

4. Control

4.1 Stop

Shutdown occurs for one of the following reasons:

- A Abnormal shutdown: in order to protect the compressors and other components, if an abnormal state occurs the system stops and an error code is displayed on the PCB digital displays and on the user interface.
- B The system stops when the set temperature has been reached.

4.2 Standby

4.2.1 Compressor crankcase heater

The compressor crankcase heater is used to prevent refrigerant from mixing with compressor oil when the compressor is stopped.

It is controlled according to the outdoor ambient temperature and the compressor on/off status.

When the outdoor ambient temperature is above 8°C or the compressor is in operation, the heater is off.

When the outdoor ambient temperature is at or below 8°C and either the compressor has been stopped for more than 3 hours or the unit has just been switched on (manually or when the power supply has returned following a power failure), the heater switches on.

4.2.2 Water circulator

There are several cases depending on the type of control set on the unit:

1. Control of system water temperature:

- when the set point is reached, the internal circulator continues to run continuously

2. Control by ambient thermostat:

- when the set point is reached, the internal circulator stops

- when the set point is reached, the internal circulator switches on every 6 hours for 3 minutes

Note: the internal circulator operates continuously during defrosting and antifreeze operations.

4.3 Startup control

4.3.1 Delayed compressor startup

In initial startup control and in re-start control (except in oil return and defrosting operations), compressor activation is delayed to allow a minimum time to elapse in order to prevent frequent compressor switching on/off and to equalise the pressure within the refrigerant circuit. The compressor re-start delays for cooling and heating modes are set on the user interface. Refer to the installation manual: Heating/cooling modes setting.

4.3.2 Compressor startup

In initial startup control and in re-start control, compressor activation is controlled according to outdoor temperature. Compressor startup follows one of two startup programs until the set rotation speed is reached.

CONTROL

4.3.2.1 Sizes 2.1 - 3.1 - 6.1 - 7.1 - 8.1: ambient temperature higher than 3°C

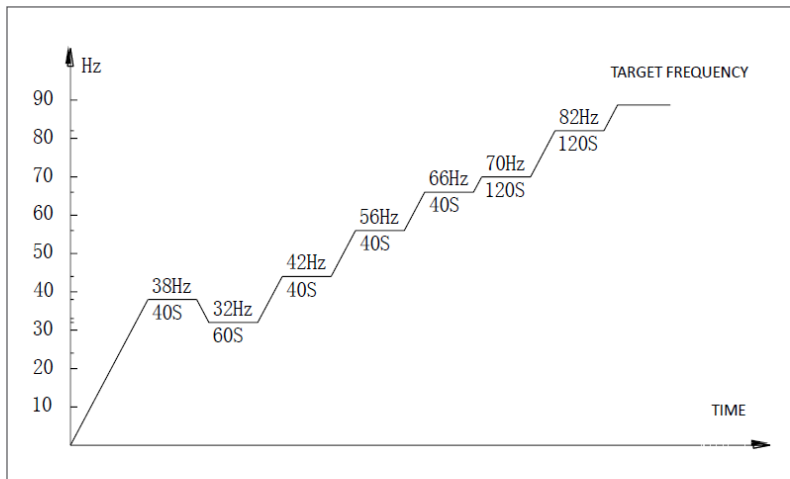

4.3.2.2 Sizes 4.1 - 5.1: ambient temperature higher than 11°C

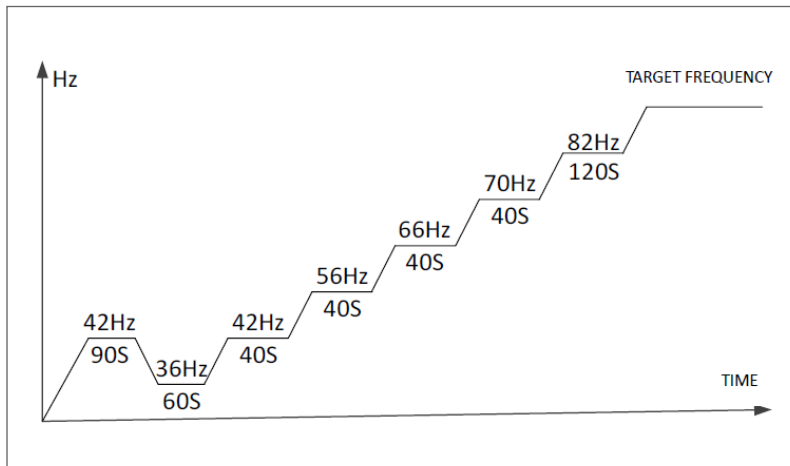

4.3.2.3 Sizes 2.1 - 3.1: ambient temperature at or lower than 3°C
Sizes 4.1 - 5.1: ambient temperature at or lower than 11°C

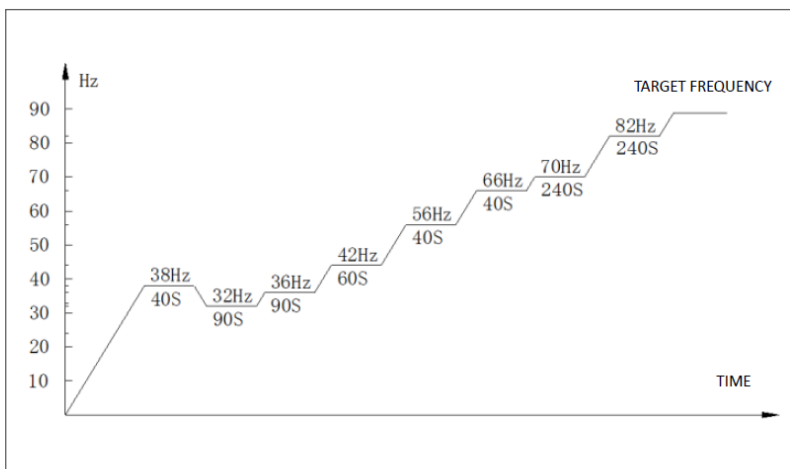

CONTROL

4.3.2.4 Sizes 6.1 - 7.1 - 8.1 / 6.1T - 7.1T - 8.1T: ambient temperature or lower than 3°C

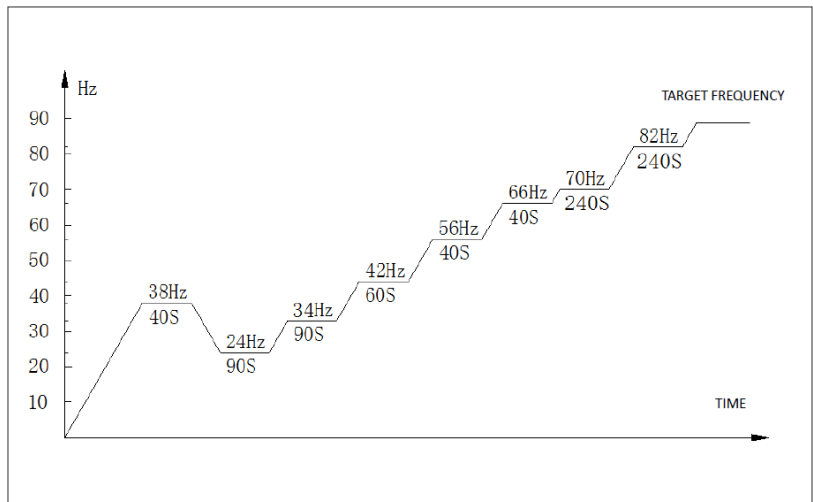

4.3.2.5 Sizes 9.1 - 14.1: ambient temperature higher than 8°C

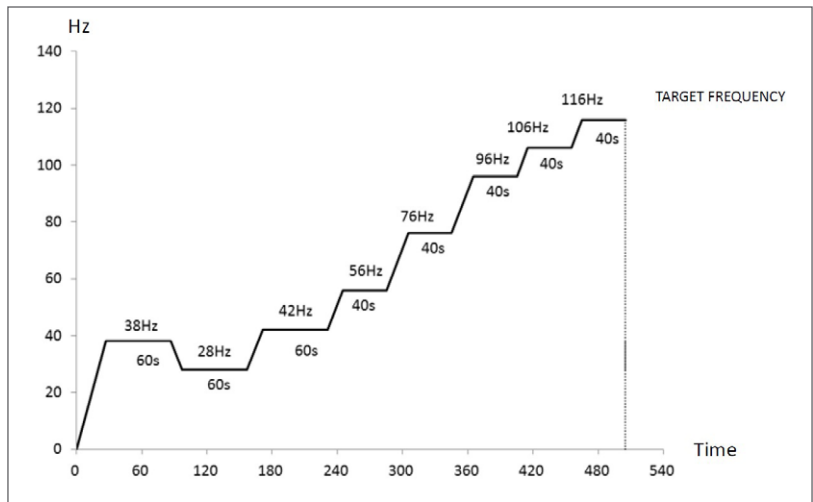

4.3.2.6 Sizes 9.1 - 14.1: ambient temperature at or lower than 8°C

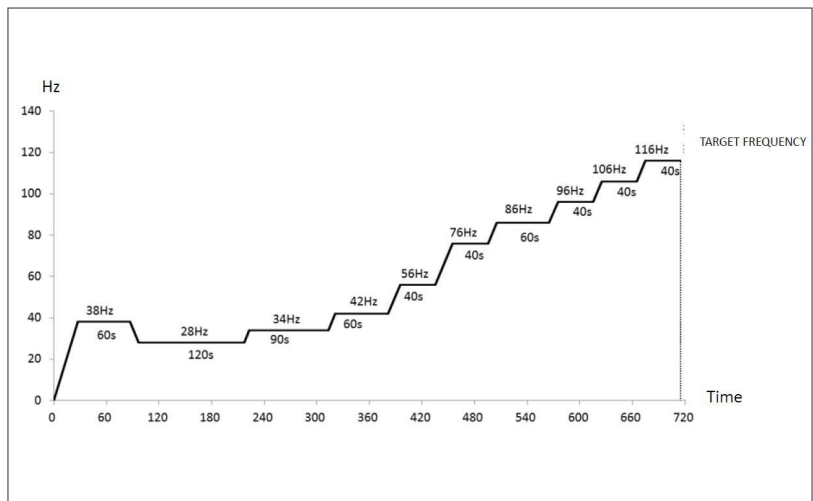

CONTROL

4.4 Startup in heating and domestic hot water mode

Component	Refer to wiring diagram	Control functions and states
DC inverter compressor	COMP	Compressor startup program selected according to ambient temperature ¹
Fan	FAN	Fan run at maximum speed ²
Electronic expansion valve	EXV	Position (steps) from 0 (fully closed) to 480 (fully open), controlled according to outdoor ambient temperature, discharge temperature, suction overheating, compressor speed and refrigerant circuit pressure
4-way valve	STF*/STF1**	.On

* Single-phase version

** Three-phase version

Notes:

- 1 Refer to the curves in paragraph 4.3.2
- 2 Refer to paragraph 4.6.7

4.5 Startup in cooling mode

Component	Refer to wiring diagram	Control functions and states
DC inverter compressor	COMP	Compressor startup program selected according to ambient temperature ¹
Fan	FAN	Fan run at maximum speed ²
Electronic expansion valve	EXV	Position (steps) from 0 (fully closed) to 480 (fully open), controlled according to outdoor ambient temperature, discharge temperature, suction overheating, compressor speed and refrigerant circuit pressure.
4-way valve	STF*/STF1**	Off

* Single-phase version

** Three-phase version

Notes:

- 1 Refer to the curves in paragraph 4.3.2
- 2 Refer to paragraph 4.6.7

CONTROL

4.6 Normal operation

4.6.1 Component control in heating and domestic hot water mode

Component	Refer to wiring diagram	Control functions and states
DC inverter compressor	COMP	Controlled according to load requirement from hydronic system
Fan	FAN	Controlled according to outdoor heat exchanger temperature
Electronic expansion valve	EXV	Position (steps) from 0 (fully closed) to 480 (fully open), controlled according to outdoor ambient temperature, discharge temperature, suction overheating, compressor speed and refrigerant circuit pressure.
4-way valve	STF*/STF1**	On

* Single-phase version

** Three-phase version

4.6.2 Component control in cooling mode

Component	Refer to wiring diagram	Control functions and states
DC inverter compressor	COMP	Controlled according to load requirement from hydronic system
Fan	FAN	Controlled according to outdoor heat exchanger temperature
Electronic expansion valve	EXV	Position (steps) from 0 (fully closed) to 480 (fully open), controlled according to outdoor ambient temperature, discharge temperature, suction overheating, compressor speed and refrigerant circuit pressure.
4-way valve	STF*/STF1**	Off

* Single-phase version

** Three-phase version

4.6.3 Compressor control

The compressor rotation speed is controlled according to the load requirement.

Before compressor startup, the outdoor unit determines the speed according to outdoor ambient temperature, the set-point and actual water outlet temperature, as shown in paragraph 4.3.2.

Once the startup program is complete, the compressor runs at the set rotation speed.

During operation, the compressor speed is controlled according to the variation ratio of the water temperature, the water pressure and the refrigerant temperature.

4.6.4 Compressor control step

The operation speed of six-pole compressors in rotations per second (rps) is one third of the frequency (in Hz) of the electrical input to the compressor motor.

The frequency of the electrical input to the compressor motors can be altered at a speed of 1Hz per second.

4.6.5 4-way valve control

The four-way valve is used to change the direction of refrigerant flow through the water side heat exchanger in order to switch between cooling and heating/DHW modes. Refer to paragraphs 3.2 and 3.3.

CONTROL

During heating and DHW operations, the four-way valve is on; during cooling and defrosting operations, the four-way valve is off.

4.6.6 **Electronic expansion valve control**

The position of the electronic expansion valve (EXV) is controlled in steps from 0 (fully closed) to 480 (fully open).

- At switch-on
 The EEV first closes fully, then moves to the standby position.
 After a few seconds, the EEV moves to an initial operating position, which is determined according to outdoor ambient temperature.
 After a few minutes, the EEV is controlled according to suction and discharge overheating temperature.
 After a few minutes, the EEV is controlled according to overheating and discharge temperature and compressor speed.
- When the outdoor unit is in standby:
 The EEV is in standby
- When the outdoor unit stops:
 The EEV first closes fully and then moves to standby.

4.6.7 **Outdoor fan control**

The outdoor fan speed is controlled as shown in Table

Fan speed index	Fan speed (rpm)				
	2,1-3.1-4.1-5.1	6.1 - 7.1	8.1	9.1-10.1-12.1-14.1	
W1	200	200	200	200	180
W2	250	250	250	280	260
W3	300	300	300	340	320
W4	350	350	350	400	380
W5	400	400	400	460	440
W6	450	450	450	520	500
W7	500	500	500	580	560
W8	530	550	550	640	620
W9	550	580	600	700	680
W10	580	610	650	760	740
W11	600	630	700	820	800
W12	600	650	730	880	860
W13	-	-	-	900	900

9.1-10.1-12.1-14.1 : left column = Upper fan; right column = lower fan

CONTROL

4.7 **Protection control**

4.7.1 **High pressure protection control**

This control protects the refrigerant circuit from abnormally high pressure and protects the compressor from transient spikes in pressure.

Normal operation (sizes 2.1 to 8.1)



High pressure protector, error code P1 is displayed

Normal operation (sizes 9.1 to 14.1)



High pressure protector, error code P1 is displayed

Pc: discharge pressure

When the discharge pressure rises above 4.3 MPa the system displays P1 protection and the unit shuts down. When the discharge pressure drops below 3.6 MPa, the compressor enters re-start control.

4.7.2 **Low pressure protection control**

This control protects the refrigerant system from abnormally low pressure and protects the compressor from transient drops in pressure.

Normal operation



Low pressure protection, error code P0 is displayed

Pe: suction pressure

When P0 protection occurs 3 times in 60 minutes, the HP error is displayed.

When an HP error occurs, a manual system restart is required before the system can resume operation.

When the suction pressure drops below 0.14 MPa, the system displays P0 protection and the unit shuts down.

When the suction pressure rises above 0.3 MPa, the compressor enters re-start control.

CONTROL

4.7.3 **High discharge temperature protection control**

This control protects the compressor from abnormally high temperatures and transient spikes in temperature.

Normal operation (sizes 2.1 to 8.1)



High discharge temperature protection, error code P4 is displayed

Normal operation (sizes 9.1 to 14.1)



High discharge temperature protection, error code P4 is displayed

When the discharge temperature rises above 115°C, the system displays P4 protection and the unit shuts down. When the discharge temperature drops below 95°C, the compressor enters re-start control.

4.7.4 **Low discharge temperature protection control**

Normal operation



Low discharge temperature protection, error code EA is displayed

When the discharge temperature (T_p) is below suction temperature (T_h) for more than 5 minutes, the system displays EA protection and the unit shuts down.

When the discharge temperature is higher than the suction temperature, the compressor enters re-start control.

CONTROL

4.7.5 **Compressor current protection control**

This control protects the compressor from abnormally high currents.

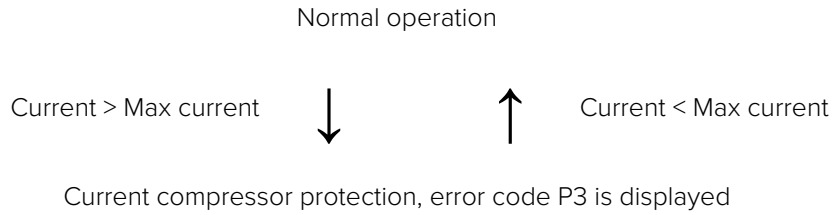

Size	2.1 - 3.1	4.1 - 5.1	6.1-7.1-8.1	6.1T-7.1T-8.1T	9.1	10.1	12.1	14.1
Maximum current	18A	19A	30A	14A	28A	28A	28A	28A

When the compressor current rises above the maximum current, the system displays P3 protection and the unit shuts down.

When the compressor current drops below the maximum current, the compressor enters re-start control.

4.7.6 **Voltage protection control**

This control protects the unit from abnormally high or abnormally low voltages.

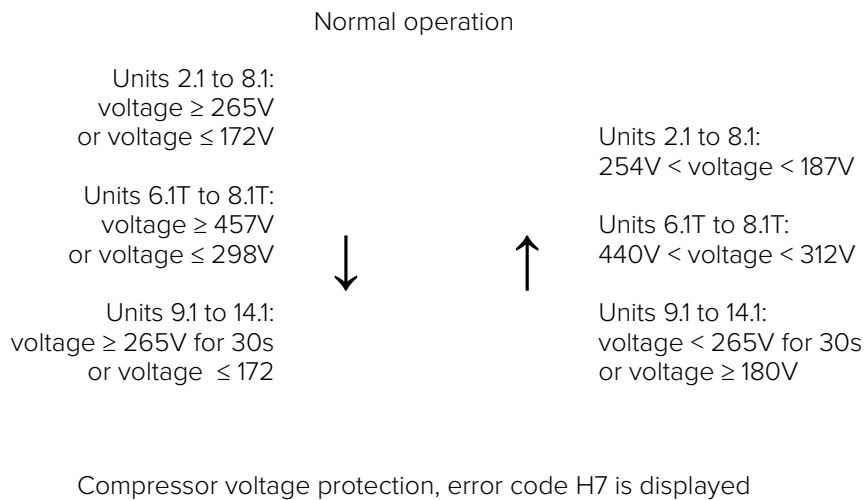

For single-phase unit, when the AC power supply voltage is at or above 265 V for more than 30 seconds, the system displays H7 protection and the unit shuts down.

When the voltage drops below 265 V for more than 30 seconds, the refrigerant circuit restarts once the compressor re-start delay has elapsed.

When the voltage is below 172 V, the system displays H7 protection and the unit shuts down.

When the AC voltage rises to more than 180 V, the refrigerant circuit restarts once the compressor re-start delay has elapsed.

For three-phase unit, when the AC power supply voltage is at or above 457 V for more than 30 seconds, the system displays H7 protection and the unit shuts down.

When the voltage drops below 440 V for more than 30 seconds, the refrigerant circuit restarts once the compressor re-start delay has elapsed.

When the voltage is below 298 V, the system displays H7 protection and the unit shuts down.

When the AC voltage rises to more than 312 V, the refrigerant circuit restarts once the compressor re-start delay has

CONTROL

elapsed.

4.7.7 DC fan motor protection control

This control protects the DC fan motor from strong winds and abnormal power supply.

DC fan motor protection occurs when any one of the following three sets of conditions are met:

- A The outdoor ambient temperature is at or above 4°C and actual fan speed differs from set fan speed by 200 rpm or more for more than 3 minutes.
- B The outdoor ambient temperature is below 4°C and actual fan speed differs from set fan speed by 300 rpm or more for more than 3 minutes.
- C Actual fan speed is less than 150 rpm for more than 20 seconds.

When DC fan motor protection control occurs, the system displays the H6 error code and the unit shuts down. After 3 minutes, the unit restarts automatically.

When H6 protection occurs 10 times in 120 minutes, the HH error is displayed. When an HH error occurs, a manual system restart is required before the system can resume operation.

4.7.8 Water side exchanger antifreeze protection control

In cooling mode, if:

- either the inlet water temperature
- or the outlet water temperature
- or the auxiliary heat source outlet water temperature

is below 4°C, the antifreeze protection activates.

In heating/DHW mode, if:

- either the ambient temperature is below 3°C and the inlet water temperature or the auxiliary heat source outlet water temperature is below 5°C;
- or the outlet water temperature is below 2°C

The antifreeze protection activates.

When water side heat exchanger antifreeze protection occurs, the system displays error code Pb and the unit shuts down.

CONTROL

4.7.9 **Module temperature protection control**

This control protects the module from abnormally high temperatures.

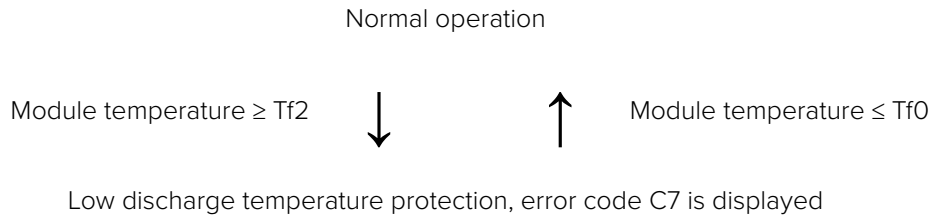

When the module temperature rises to or above Tf2, the system displays C7 protection and the unit shuts down.

When the module temperature drops to or below Tf0-1, the compressor enters re-start control.

	2.1 - 3.1	4.1 - 5.1	6.1-7.1-8.1	6.1T-7.1T-8.1T	9.1	10.1	12.1	14.1
Tf2	75	81	100	84	88	88	88	88
Tf0	69	75	94	78	81	81	81	81

4.8 **Special controls**

4.8.1 **Oil return operation**

In order to prevent the compressor from running out of oil, the oil return operation is enabled to recover oil that has flowed out of the compressor and into the refrigerant piping.

The oil return operation starts when the following condition occurs:

- when the compressor cumulative operating time with a rotation speed less than 42 rps reaches 6 hours.

The oil return operation ceases when any one of the following three conditions occurs:

- oil return operation duration reaches 5 minutes,
- compressor stops.

4.8.1.1 **Component control during oil return operation in cooling mode.**

Component	Refer to wiring diagram	Control functions and states
DC inverter compressor	COMP	Runs at oil return operation rotation speed
Fan	FAN	Controlled according to cooling mode
Electronic expansion valve	EXV	304 (steps)
4-way valve	STF*/STF1**	Off

* Single-phase version

** Three-phase version

CONTROL

4.8.1.2 Component control during oil return operation in heating and DHW modes.

Component	Refer to wiring diagram	Control functions and states
DC inverter compressor	COMP	Runs at oil return operation rotation speed
Fan	FAN	Controlled according to heating mode
Electronic expansion valve	EXV	304 (steps)
4-way valve	STF*/STF1**	On

* Single-phase version

** Three-phase version

4.8.2 Defrosting

In order to recover heating capacity, the defrosting operation is carried out when the unit's air side heat exchanger is performing as an evaporator.

The defrosting operation is controlled according to outdoor ambient temperature, air side heat exchanger refrigerant outlet temperature and the compressor operating time.

Inlet conditions:

- $T_3 < 0^\circ\text{C}$
- $T_4 < -2 \dots -10$ (according to water outlet temperature and permanence in these conditions).

Outlet conditions:

- after 10 minutes of defrosting cycle
- $T_3 > 8^\circ\text{C}$

Component	Refer to wiring diagram	Control functions and states
DC inverter compressor	COMP	Runs at defrosting operation rotation speed
Fan	FAN	Off
Electronic expansion valve	EXV	Fully open (480 steps)
4-way valve	STF*/STF1**	Off

* Single-phase version

** Three-phase version

CONTROL

4.8.3 Fast DHW Operation

Fast DHW operation is used to quickly fulfil a requirement for domestic hot water when DHW priority has been set on the user interface. Refer to installation manual of SPHERA EVO 2.0, Part 10 "Control".

Component	Refer to wiring diagram	Control functions and states
DC inverter compressor	COMP	Controlled according to load requirement
Fan	FAN	Controlled according to outdoor heat exchanger temperature
Electronic expansion valve	EXV	Position (steps) from 0 (fully closed) to 480 (fully open), controlled according to discharge overheating
4-way valve	STF*/STF1**	On

* Single-phase version

** Three-phase version

4.8.4 2-area control

The 2-area control function is used to control the temperature of each area separately.

In cooling mode, when the set temperature is reached in one of the two areas, the area pump switches off.

The same thing happens in heating mode, with the addition of the control function of the 3-way mixing valve (SV3) which is activated to control the water temperature in the low temperature area.

The 3-way mixing valve (SV3) will only turn on when the control of the 2 areas is activated.

CONTROL

4.8.5 Photovoltaic and Smart Grid

The unit is Smart Grid Ready certified and is equipped with logic for connection to devices that balance loads connected to the power grid and optimise overall power consumption. Connection is optional and the function can be enabled at the keyboard and is linked to the SG ON/OFF input, which receives a status signal from the mains.

The unit is also able to automatically consume the excess energy produced by a photovoltaic system, using it to store free thermal energy in the DHW tank. The function is enabled by default, it does not require any keyboard settings and is tied to the ON/OFF EVU input, which receives a signal from the energy meter indicating when excess free energy is available to the unit.

The control logic of the two contacts is:

Energy cost	Contact		ELECTRIC HEATER AVAILABLE	Operation	
	SG	EVU		System	DWH
Free	ON	ON	-	Standard	When there is no demand for system heating/cooling: forced domestic hot water operation with T5S set point = 60°C
			IBH		Forced domestic hot water operation with T5S set point = 70°C. TBH is forcibly started until the domestic hot water set point is reached. If necessary, the Heat Pump can work simultaneously on the Heating/Cooling system.
			TBH		
			IBH + TBH*		
Economical	OFF	ON	-	Standard	The domestic hot water set point is forced to T5S + 3°C
			IBH		The domestic hot water set point is forced to T5S + 3°C The TBH is forced to start when T5 < T5s - 2°C and stops when T5 ≥ T5s + 3°C
			TBH		
			IBH + TBH*		
Standard	OFF	OFF	any	Standard	Standard
Expensive	ON	OFF	-	Forced OFF	Forced OFF**
			IBH / TBH		

* when IBH and TBH are enabled together, IBH can only be used for system heating.

** DISINFECT, FAST DHW, STORAGE TANK and other domestic hot water-related functions do not work.

The frost protection and defrosting operate smoothly in all conditions.

if AHS is available, it can operate for Heating, Cooling or DHW in any of these conditions.

CONTROL

4.8.6 **Balance tank temperature control**

The balance tank temperature sensor is used to control switch-on/off of the heat pump.

When the heat pump stops, the internal pump stops to save energy and the balance tank provides hot water to heat the room. Furthermore, temperature control of the balance tank allows both room heating and domestic hot water requirements to be fulfilled simultaneously. The balance tank can store energy to provide hot water while the heat pump runs in heating/cooling mode, which can reduce host selection and initial investment.

4.8.7 **USB data transfer**

- Convenient programme update
- Transmission of parameter settings between wired controllers. It is recommended to do this in case there is a master back-up so as to copy all configurable parameters exactly. Otherwise, only a few key parameters remain in the M/S system memory when the Master fails.

CONTROL

4.8.8 M1M2 dry contact control

M1M2 can be set in the wired controller for heat pump on/off control, TBH control and AHS control.

- For heat pump on/off control.
When the dry contact closes for 1s, the heat pump stops.
When the dry contact opens for 5 seconds, the heat pump switches on/off according to the setting of the wired controller or ambient thermostat.
- For TBH control, TBH is only controlled by M1M2. If the dry contact closes, T5 < 65 °C then TBH opens until the water tank temperature reaches 70 °C.
- For AHS control In heating mode, AHS switch-on/off is only controlled by M1M2. In DHW mode, M1M2 control does not affect AHS switch-on/off

4.8.9 Temperature probes

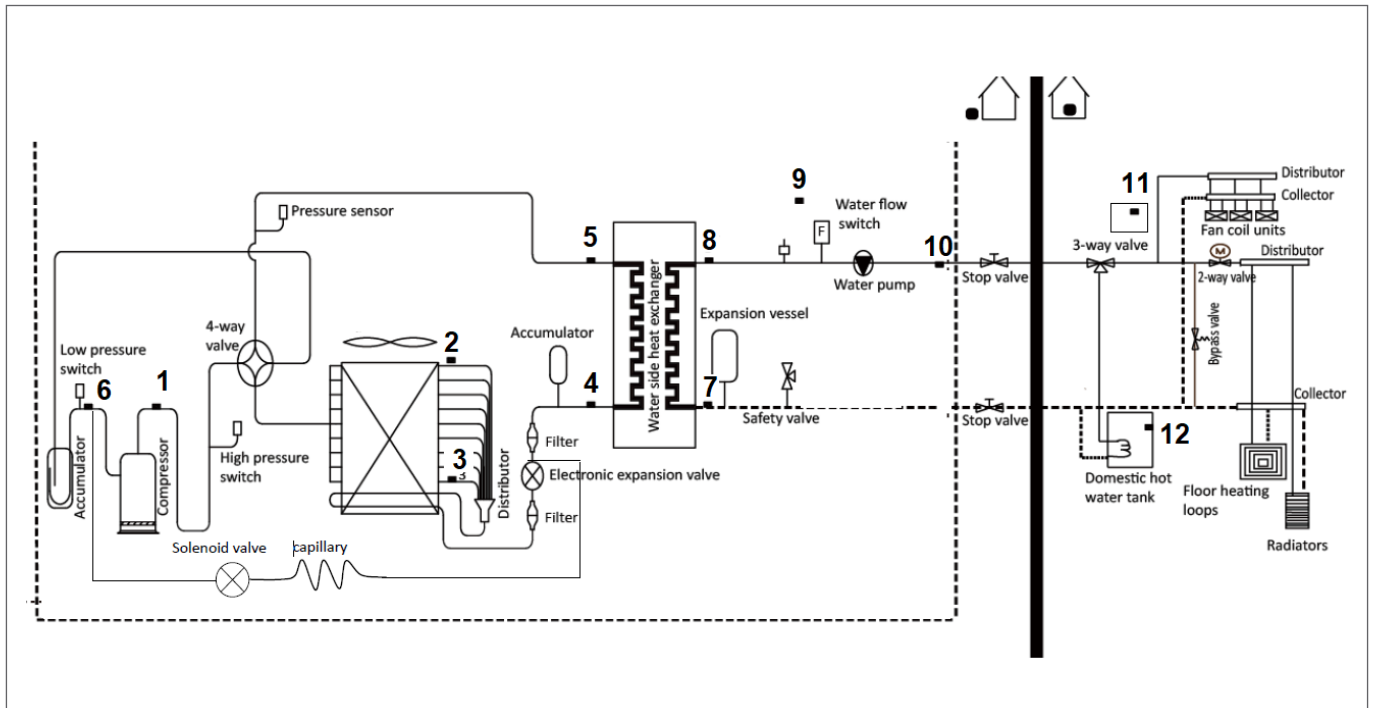

	Sensor name	Sign	Mode	Functions
1	Discharge temperature sensor	Tp	H	<ul style="list-style-type: none"> • electronic expansion valve • discharge temperature
			C	<ul style="list-style-type: none"> • electronic expansion valve • discharge temperature • fans

CONTROL

2	Outdoor temperature sensor	T4	H	<ul style="list-style-type: none"> • compressor drive4 • compressor output5 • electronic expansion valve2 • defrosting operation7 • low pressure protection7 • Carter heater control9
			C	<ul style="list-style-type: none"> • compressor drive4 • compressor output5 • electronic expansion valve2 • fans3 • carter heater9
3	Air side exchanger refrigerant outlet temperature sensor	T3	H	<ul style="list-style-type: none"> • Electronic expansion valve 2 • Defrosting operation 7 • External fan 3
			C	<ul style="list-style-type: none"> • Compressor output 5 • External fan 3
4	Water side heat exchanger refrigerant outlet (liquid pipe) temperature sensor	T2	H ACS	<ul style="list-style-type: none"> • Compressor output 5
5	Water side heat exchanger refrigerant outlet (gas pipe) temperature sensor	T2B	H	<ul style="list-style-type: none"> • antifreeze 10
6	Suction pipe temperature sensor	Th		<ul style="list-style-type: none"> • Electronic expansion valve 2
7	Water side heat exchanger water inlet temperature sensor	Tw_in		<ul style="list-style-type: none"> • antifreeze 10
8	Water side heat exchanger water outlet temperature sensor	Tw_out		<ul style="list-style-type: none"> • Compressor output5 and on/off 6 • antifreeze 10
9	Water outlet temperature sensor of the backup heater or additional heating source (IBH and/or AHS)	T1	H	<ul style="list-style-type: none"> • Compressor output5 • Backup electric heater • Hot water priority 11 • Automatic mode
			C	<ul style="list-style-type: none"> • Compressor output5 and on/off 6 • Automatic mode
			ACS	<ul style="list-style-type: none"> • Compressor output 5 • Backup electric heater • Hot water priority 11
10	Supply water flow temperature sensor for low temperature area (only in case of 2-area kit)	T1b	H	<ul style="list-style-type: none"> • Mixing valve
11	Ambient temperature sensor (on the controller)	Ta	H	<ul style="list-style-type: none"> • Automatic mode • Climate curve
			C	<ul style="list-style-type: none"> • Compressor output control5

CONTROL

12	Domestic hot water tank temperature sensor	T5	ACS	<ul style="list-style-type: none">• Disinfection• Boiler immersion heater• Backup electric heater• Auxiliary heat source• Solar energy kit• Compressor output 5• Hot water priority 11
----	--	----	-----	--

H Heating

C Cooling

ACS Domestic hot water

LAYOUT OF ELECTRICAL PANEL

5. **Layout of electrical panel**

5.1 **Sizes 2.1 - 3.1**

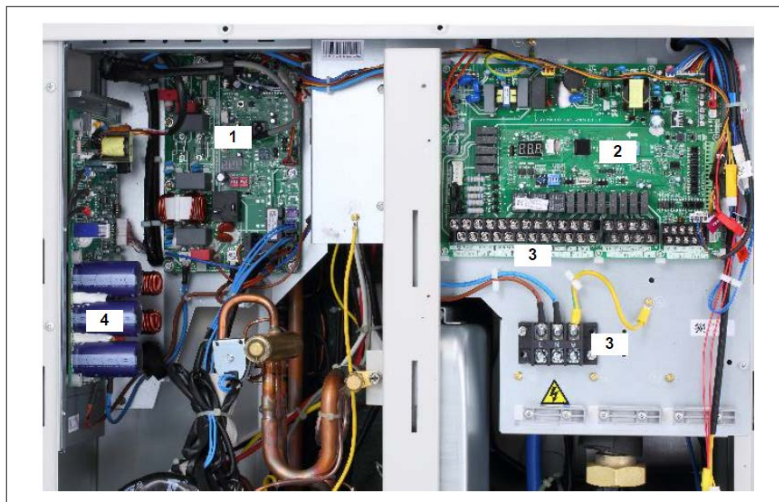

1	Refrigerant circuit board
2	Water circuit board
3	Connection terminal blocks
4	Compressor inverter

5.2 **Sizes 4.1 - 5.1**

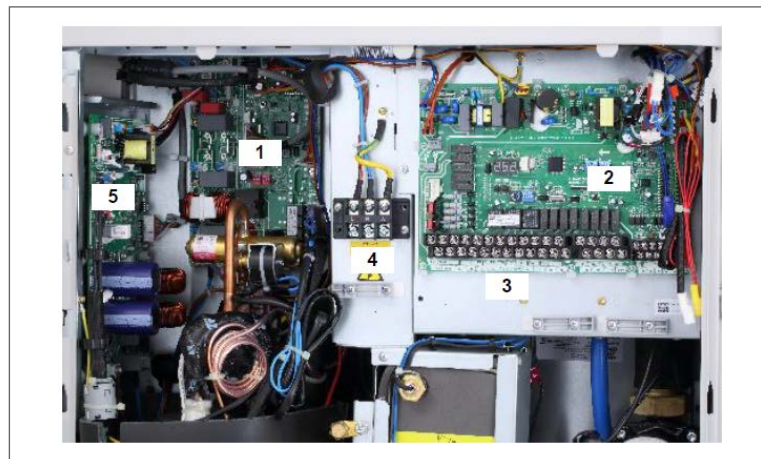

1	Refrigerant circuit board
2	Water circuit board
3	Connection terminal blocks
4	Power supply terminal block
5	Compressor inverter

LAYOUT OF ELECTRICAL PANEL

5.3 **Sizes 6.1 - 7.1 - 8.1**

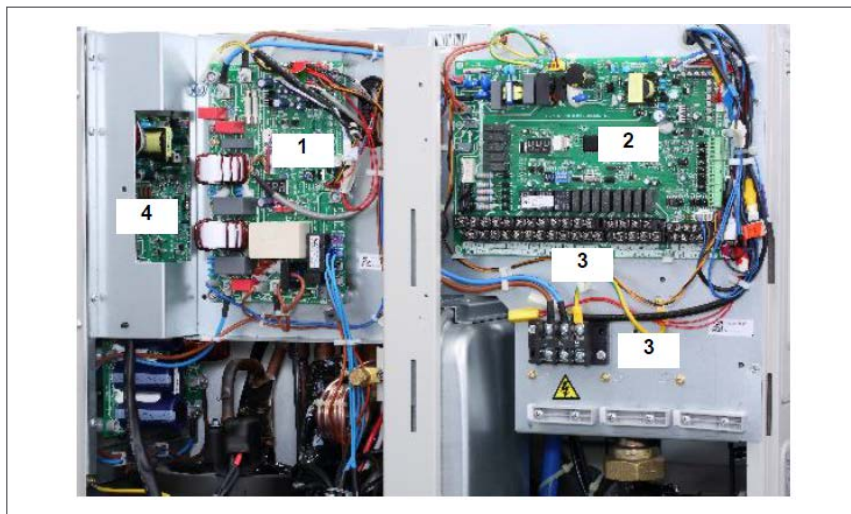

1	Refrigerant circuit board
2	Water circuit board
3	Connection terminal blocks
4	Compressor inverter

5.4 **Sizes 6.1T - 7.1T - 8.1T**

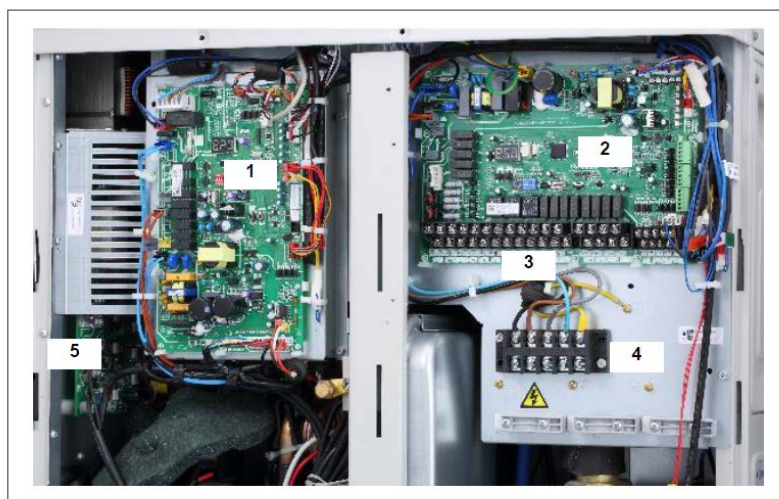

1	Refrigerant circuit board
2	Water circuit board
3	Connection terminal blocks
4	Power supply terminal block
5	Compressor inverter

LAYOUT OF ELECTRICAL PANEL

5.5 **Sizes 9.1 - 10.1 - 12.1 - 14.1**

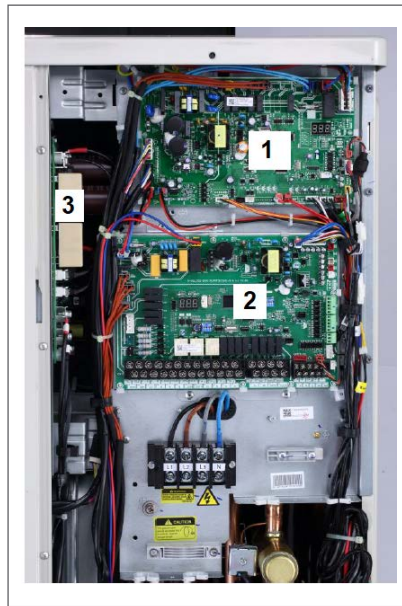

1	Refrigerant circuit board
2	Water circuit board
3	Compressor inverter

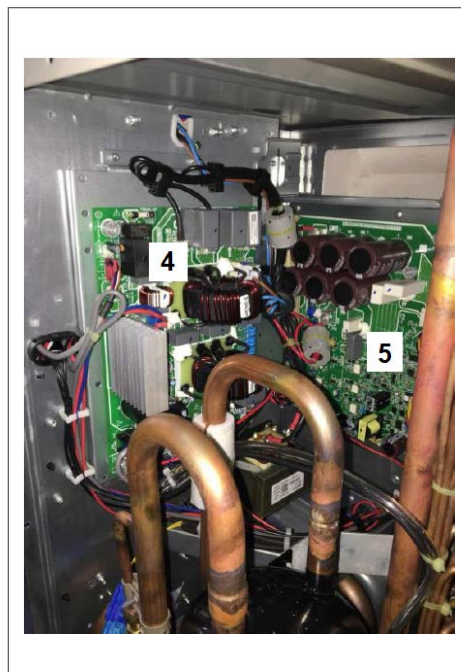

4	Filter board
5	Compressor inverter

LAYOUT OF PCB BOARDS

rif	Code	Description
1	CN21	Port for power supply
2	S3	Rotary Dip switch
3	DIS1	Digital display
4	CN5	Port for grounding
5	CN28	Port for variable speed pump power supply input
6	CN25	Port for IC programming
7	S1,S2,S4	Dip switch
8	CN4	Port for USB programming
9	CN8	Port for flow switch
10	CN6	Port for temperature sensors (T2,T2B,TW_out,TW_in, T1,)
11	CN24	Port for temperature sensor (Tbt1, inertial tank temperature probe)
12	CN16	Port for temperature sensor (Tbt2, additional DHW tank temp probe)
13	CN13	Port for temperature sensor (T5, DHW temp probe)
14	CN15	Port for temperature sensor (Tw2, only for 2 areas)
15	CN18	Port for temperature sensor (Tsolar, panel temp probe)
16	CN17	Port for variable speed pump communication
17	CN31	Control port for room thermostat (heating mode) (HT)/ Control port for room thermostat (cooling mode) (CL) / Control port for room thermostat (COM)
18	CN35	Port for smart grid (grid signal, photovoltaic signal)
19	CN36	Port for remote switch, temperature board
20	CN19	Port for communication between indoor unit and outdoor unit
21	CN14	Port for communication with wired controller
22	CN30	Port for communication with wired controller, parallel indoor unit Master-Slave connection
23	CN7	Port for antifreeze electric heating tape (internal), additional heat source, compressor/ defrosting operation
24	CN11	Control port for tank booster heater, internal backup heater 1, input port for solar energy, port for room thermostat, SV1 (3-way valve), SV2 (3-way valve), SV3 (3-way valve), area 2 pump, external circulator, solar energy pump, DHW pipe pump
25	CN2	Feedback port for outdoor temperature switch (shorted in default)
26	CN1	Feedback port for temperature switch (shorted in default)
27	CN22	Control port for backup heater 1/booster heater / reserved
28	CN41	Port for antifreeze electric heating tape
29	CN42	Port for antifreeze electric heating tape
30	CN29	Port for antifreeze electric heating tape
31	IC39	EEPROM

6.2 Refrigerant circuit board - 21.- 31 - 4.1 - 5.1

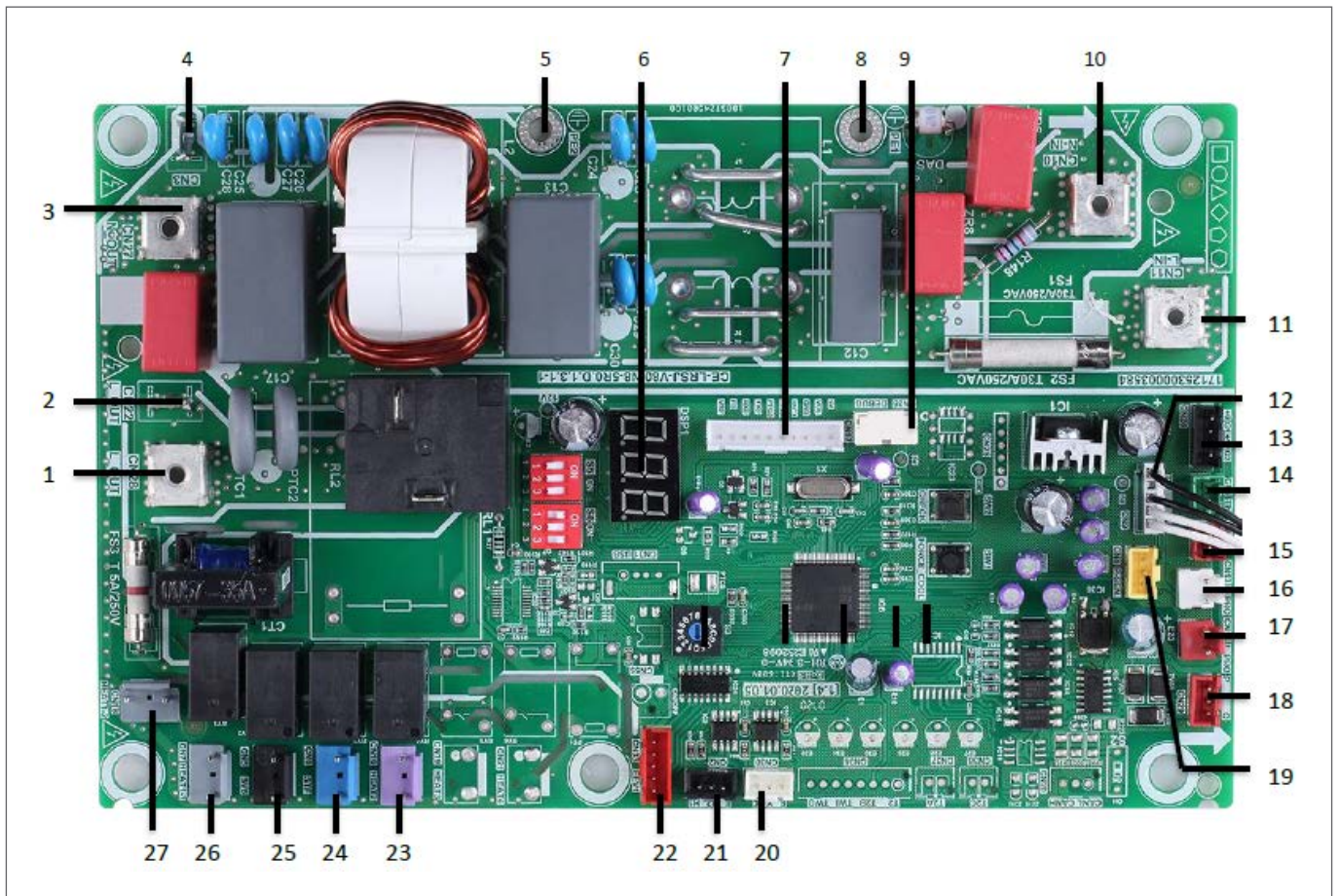

LAYOUT OF PCB BOARDS

rif	Code	Description
1	CN28	Output port L to refrigerant circuit board
2	CN22	Reserved
3	CN27	Output port N to refrigerant circuit board
4	CN3	Reserved
5	PE2	Port for grounding wire
6	DSP1	Digital display
7	CN17	Port for communication with refrigerant circuit board
8	PE1	Port for grounding wire
9	CN26	Reserved
10	CN10	Input port for neutral wire
11	CN11	Input port for line wire
12	CN9	Port for outdoor ambient temperature sensor and condenser temperature sensor
13	CN24	Input port for +12V/9V
14	CN1	Port for suction temperature sensor
15	CN8	Port for discharge temperature sensor
16	CN13	Port for high pressure switch
17	CN14	Port for low pressure switch
18	CN29	Port for communication with hydro module control board
19	CN4	Port for pressure sensor
20	CN30	Port for communication (Reserved)
21	CN2	Port for communication (Reserved)
22	CN33	Port for electronic expansion valve
23	CN16	Port for drain pan heater
24	CN6	Port for 4-way valve
25	CN5	Port for SV6 valve
26	CN7	Port for compressor electric heater1
27	CN18	Port for compressor electric heater2

6.3 Refrigerant circuit module 6.1 - 7.1 - 8.1 single-phase

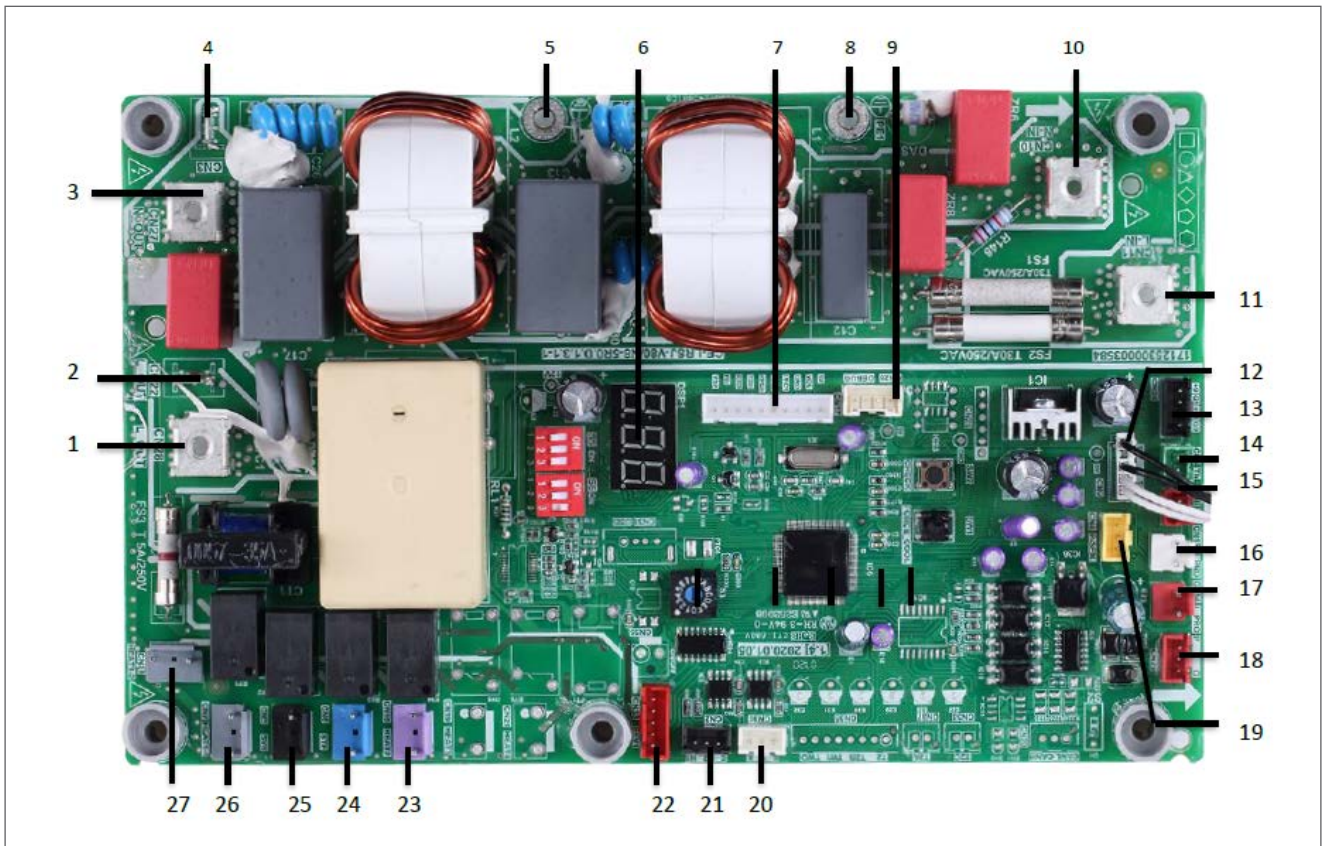

LAYOUT OF PCB BOARDS

Rif	Sign	Description
1	CN28	Output port L to MAIN CONTROL BOARD FOR REFRIGERANT SYSTEM
2	CN22	Reserved
3	CN27	Output port N to MAIN CONTROL BOARD FOR REFRIGERANT SYSTEM
4	CN3	Reserved
5	PE2	Port for earth wire
6	DSP1	Digital display
7	CN17	Port for communication with the MAIN CONTROL BOARD FOR REFRIGERANT SYSTEM
8	PE1	Port for earth wire
9	CN26	Port for IC programming
10	CN10	Input port for neutral wire
11	CN11	Input port for voltage wire
12	CN9	Connection for outdoor ambient temperature sensor and condenser temperature sensor
13	CN24	Input port for +12V/9V
14	CN1	Connection for suction temperature sensor
15	CN8	Connection for temperature sensor
16	CN13	Connection for high pressure switch
17	CN14	Connection for low pressure switch
18	CN29	Port for communication with hydro-box control board
19	CN4	Connection for pressure sensor
20	CN30	Communication port (reserved)
21	CN2	Communication port (reserved)
22	CN33	Port for electrical expansion valve
23	CN16	Reserved
24	CN6	Port for 4-way valve
25	CN5	Port for valve SV6
26	CN7	Port for compressor 1 electric heating tape
27	CN18	Port for compressor 2 electric heating tape

6.4 Refrigerant circuit module 6.1T - 7.1T - 8.1T

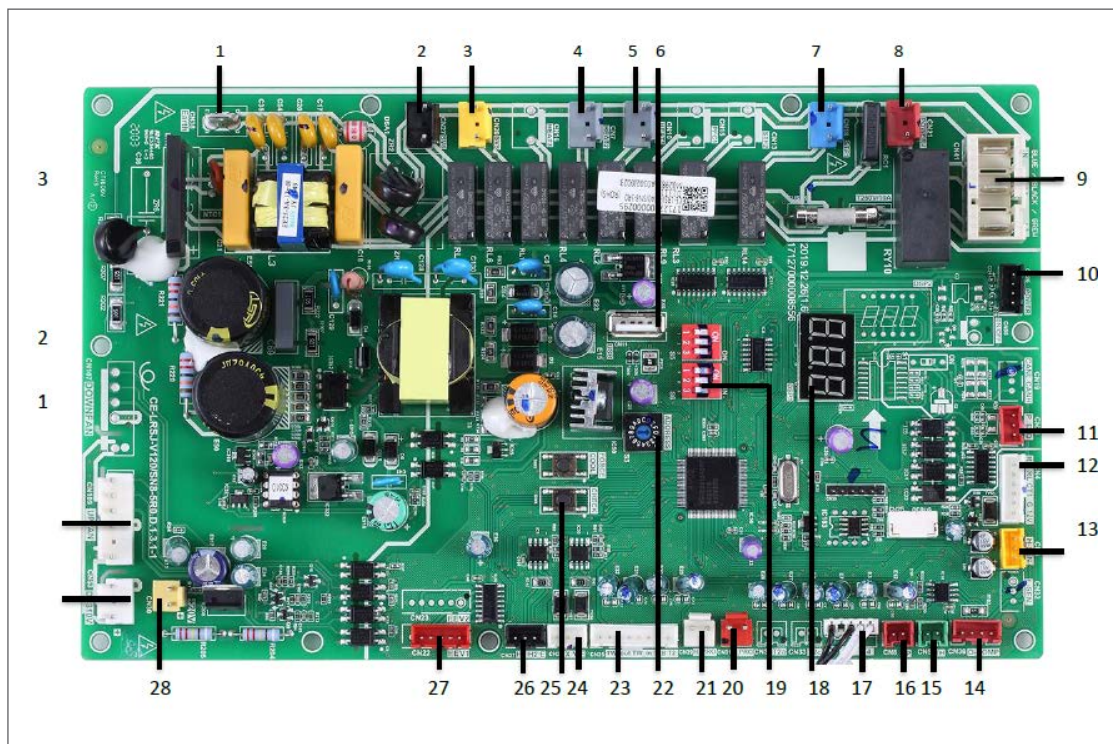

Rif	Sign	Description
1	CN38	Port for GND
2	CN27	Connection for 2-way valve 5
3	CN20	Connection for 2-way valve 6
4	CN10	Port for electric heating tape1
5	CN7	Port for electric heating tape2
6	CN11	Port for IC programming
7	CN18	Port for 4-way valve
8	CN21	Power supply socket for hydro-box control board
9	CN41	Power supply port for FILTER BOARD
10	CN26	Port for communication with Power Meter
11	CN24	Port for communication with hydro-box control board
12	CN4	Port for communication with the INVERTER MODULE BOARD
13	CN6	Connection for pressure sensor
		Port for communication with the MAIN REFRIGERANT SYSTEM CONTROL BOARD (CN36)
15	CN4	Port for temperature sensor Tp(CN4)
16	CN8	Port for temperature sensor Th(CN8)
17	CN9	Connection for outdoor ambient temperature sensor and condenser temperature sensor (CN9)

LAYOUT OF PCB BOARDS

Rif	Sign	Description
18	DSP1	Digital display (DSP1)
19	S5,S6	DIP switch (S5, S6)
20	CN31	Port for high pressure switch (CN31)
21	CN29	Connection for low pressure switch and quick control (CN29)
22	S3	Rotary immersion switch (S3)
23	CN35	Port for temperature sensors (TW_out, TW_in, T1, T2, T2B)
24	CN28	Port for XYE communication
25	S5, S6	DIP switch
26	CN37	Port for D1D2E communication
27	CN22	Port for electrical expansion valve
28	CN30	Port for 15VDC fan power supply
29	CN53	Port for 310VDC fan power supply
30	CN107	Port for fan

6.5 Refrigerant circuit module 9.1 - 10.1 - 12.1 - 14.1

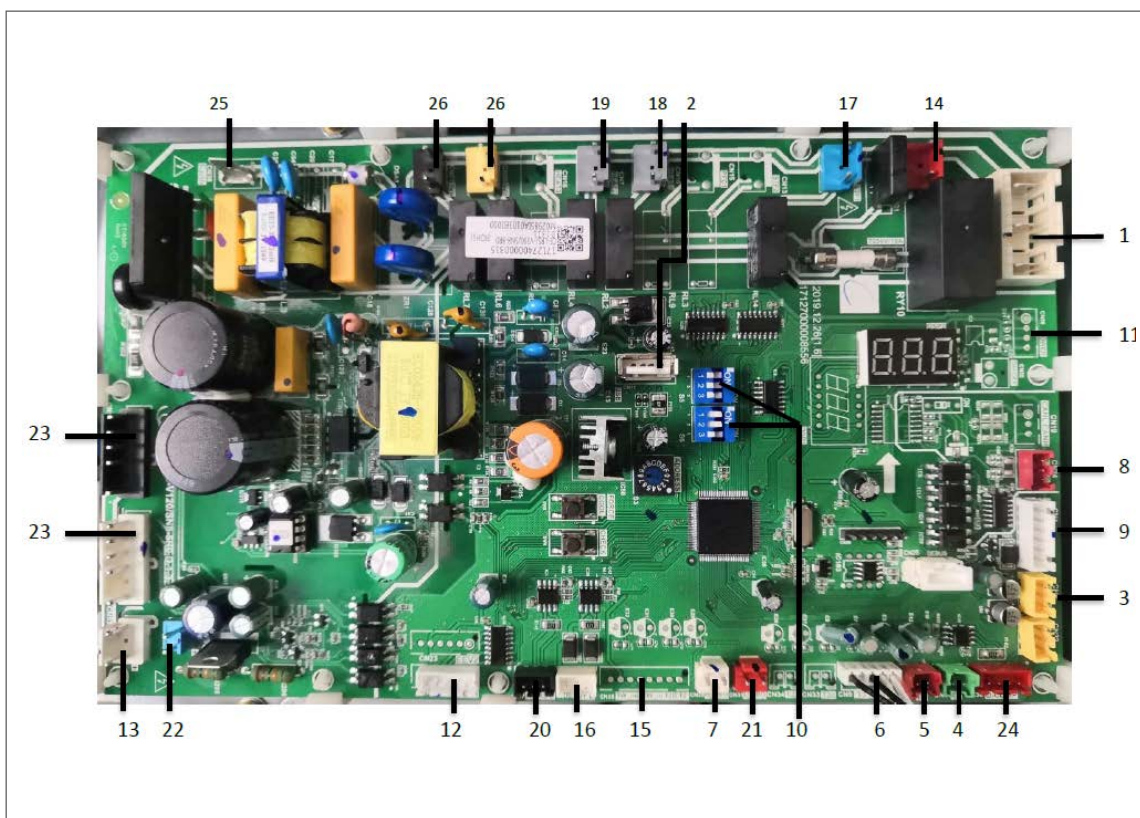

Rif	Sign	Description
1	CN41	Power supply port for PCB B
2	CN11	Port for IC programming
3	CN6	Port for pressure sensor
4	CN5	Port for suction temperature sensor
5	CN8	Port for supply temperature sensor
6	CN9	Port for outdoor ambient temperature sensor and condenser temperature sensor
7	CN29	Port for low pressure switch and quick control
8	CN24	Port for communication with hydro-box control board
9	CN4	Port for communication with PCB C
10	S5, S6	DIP switch
11	CN26	Port for communication with Power Meter
12	CN22	Port for electrical expansion valve
13	CN53	Port for 310VDC fan power supply
14	CN21	Power supply port for hydro-box control board
15	CN35	Port for another temperature sensor
16	CN28	Port for XYE communication
17	CN18	Port for 4-way valve

LAYOUT OF PCB BOARDS

Rif	Sign	Description
18	CN10	Port for electric heating tape1
19	CN7	Port for electric heating tape2
20	CN37	Port for D1D2E communication
21	CN31	Port for high pressure switch and quick control
22	CN30	Port for 15VDC fan power supply
23	CN107/109	Port for fan
24	CN36	Port for communication with PCB A
25	CN38	Port for GND
26	CN20/27	Port for SV
26	CN37	Port for D1D2E communication

6.6 Inverter module - 2.1. - 3.1

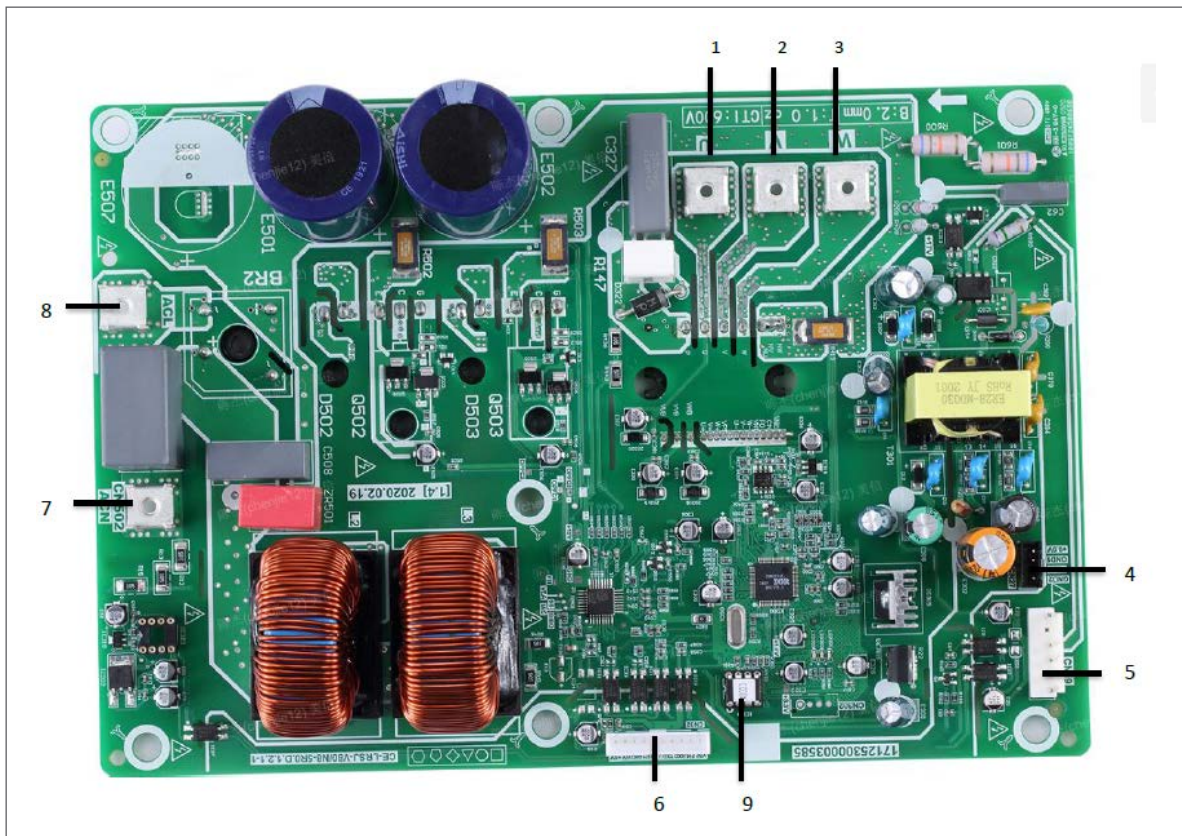

Rif	Sign	Description
1	U	Compressor connection port U
2	V	Compressor connection port V
3	W	Compressor connection port W
4	CN20	Output port for +12V/9V
5	CN19	Port for fan
6	CN32	Port for communication with main PCB for filter board
7	CN502	Input port L for rectifier bridge
8	CN501	Input port N for rectifier bridge
9	1C320	EEPROM

6.7 Inverter module - 4.1. - 5.1

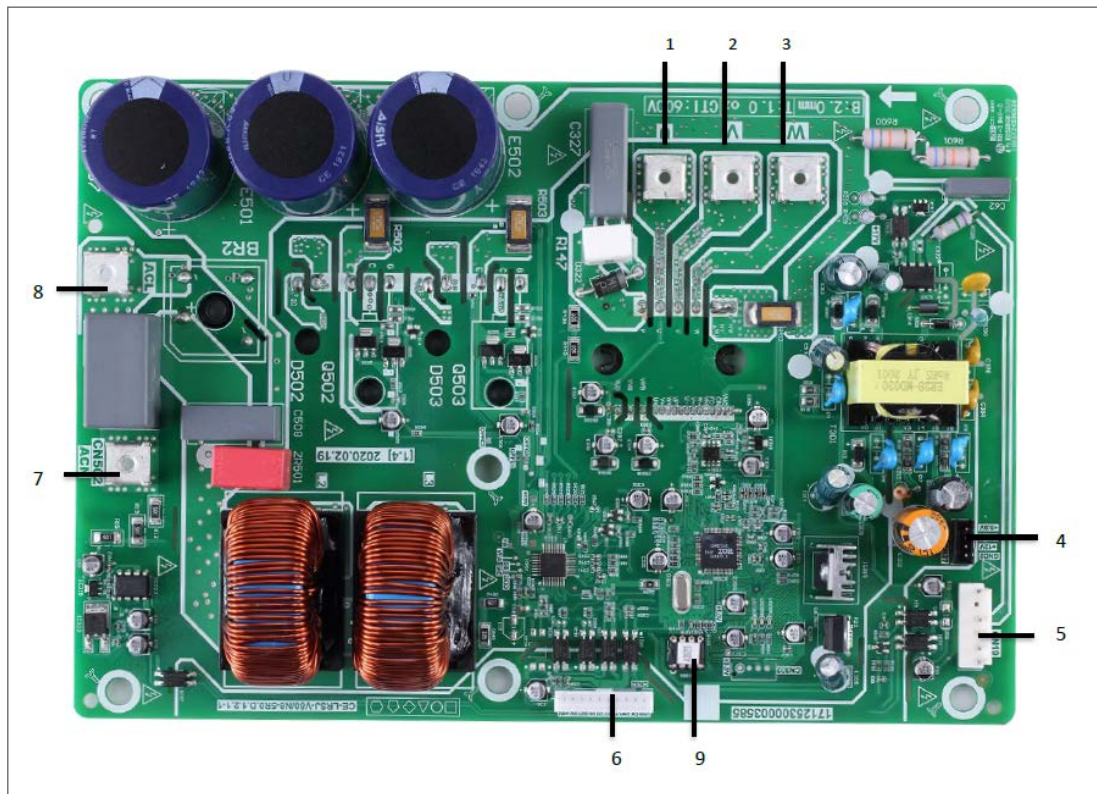

Rif	Sign	Description
1	U	Compressor connection port U
2	V	Compressor connection port V
3	W	Compressor connection port W
4	CN20	Output port for +12V/9V
5	CN19	Port for fan
6	CN32	Port for communication with main PCB for filter board
7	CN502	Input port L for rectifier bridge
8	CN501	Input port N for rectifier bridge
9	1C320	EEPROM

6.8 Inverter module - 6.1. - 7.1 - 8.1 single-phase

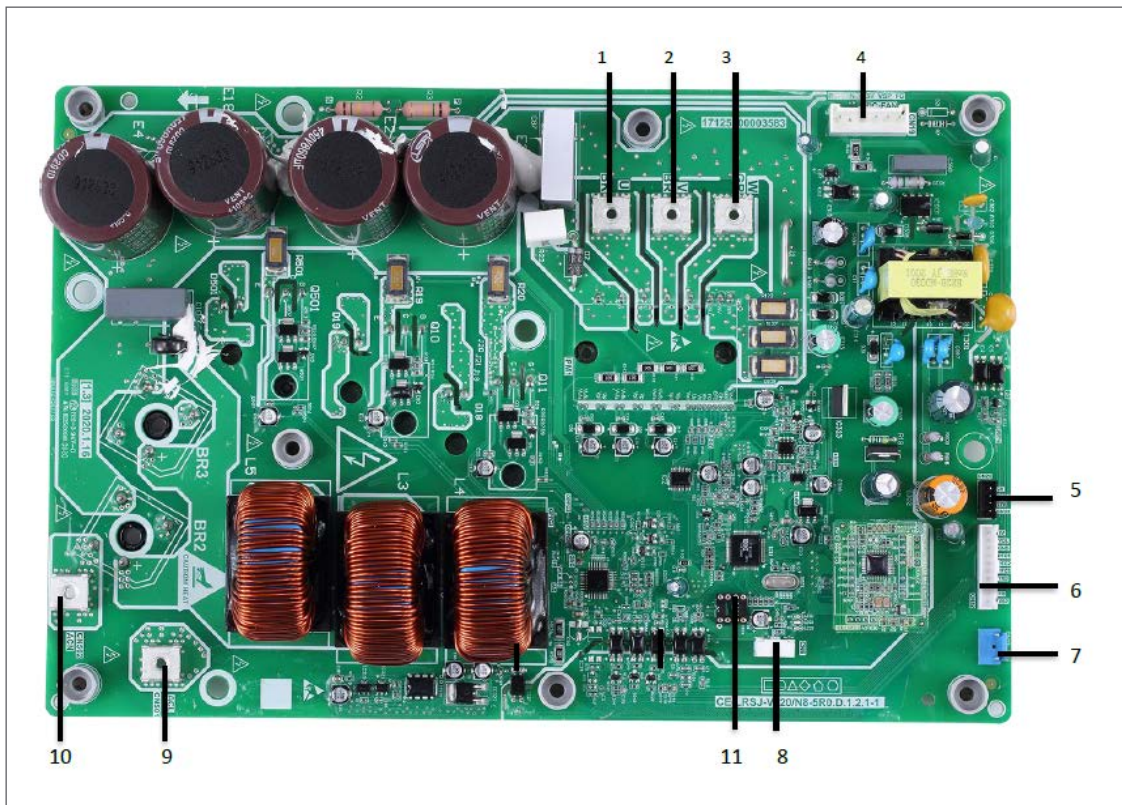

Rif	Sign	Description
1	U	Compressor connection port U
2	V	Compressor connection port V
3	W	Compressor connection port W
4	CN19	Port for fan
5	CN20	Output port for +12V/9V
6	CN32	Port for communication with main PCB for filter board
7	CN23	Port for high pressure switch
8	CN6	RESERVED
9	CN501	Input port L for rectifier bridge
10	CN502	Input port N for rectifier bridge
11	IC14	EEPROM

6.9 Inverter module - 6.1T - 7.1T - 8.1T

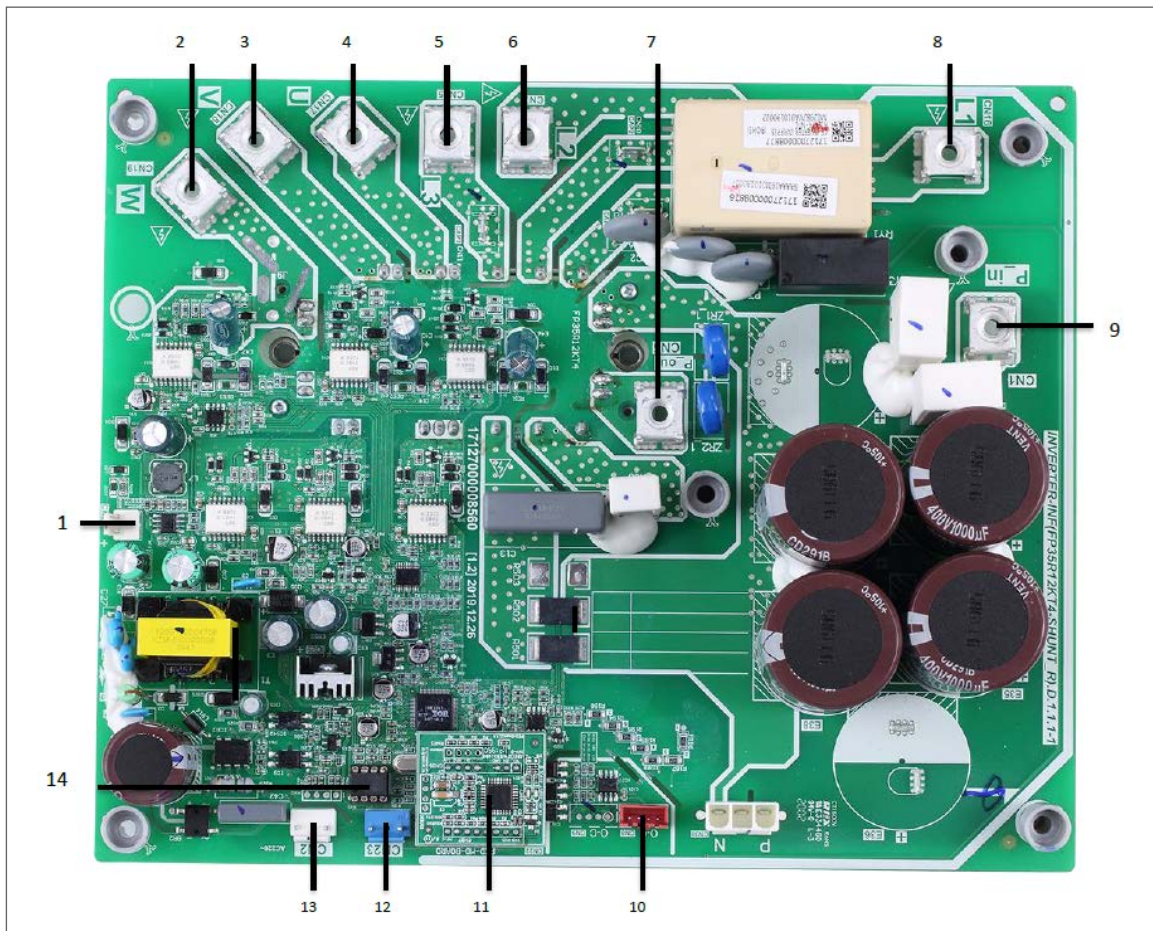

Rif	Sign	Description
1	CN4	Output port for +15V
2	W	Compressor connection port W
3	V	Compressor connection port V
4	U	Compressor connection port U
5	L1	Power supply port L1
6	L2	Power supply port L2
7	P_out	Input port P_out for IPM module
8	L3	Power supply port L3
9	P_in	Input port P_in for IPM module
10	CN1	Communication port with filter board
11	CN22	Power supply for PED board
12	CN2	Power supply for switching power output
13	CN23	Port for high pressure switch
14	IC25	EEPROM

6.10 Inverter module - 9.1. - 10.1 - 12.1 - 14.1

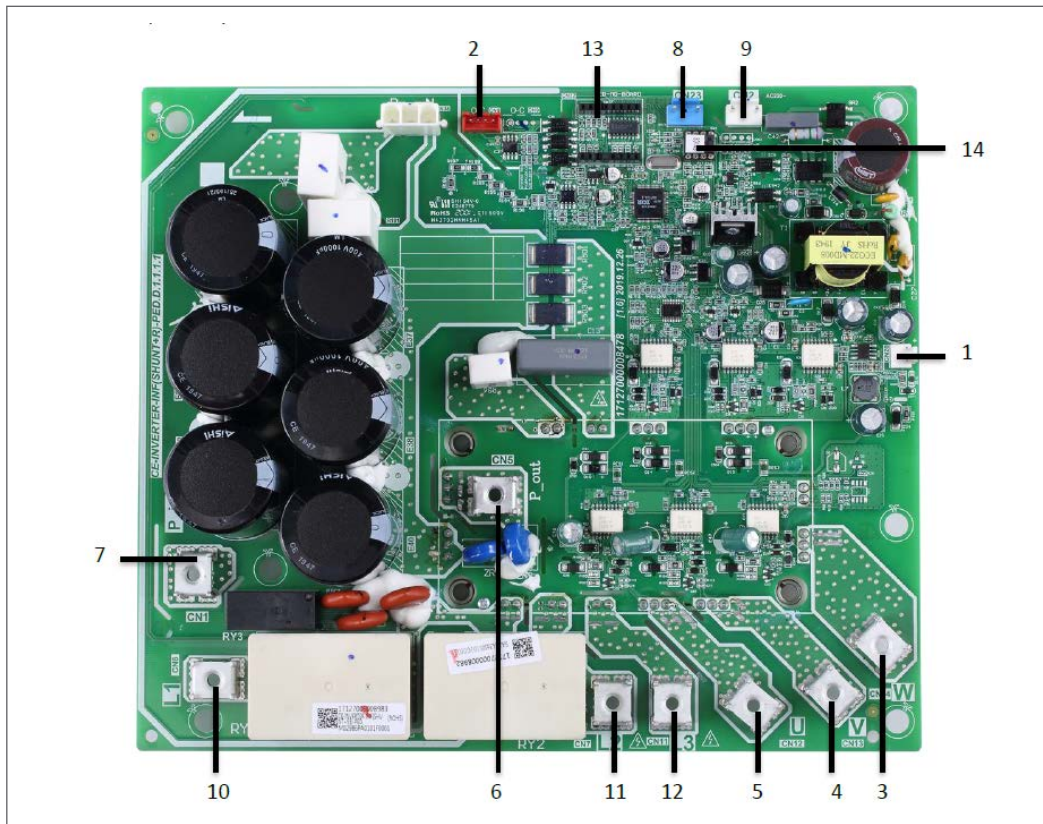

Rif	Sign	Description
1	CN20	Output port for +15V
2	CN8	Port for communication with PCB B
3	W	Compressor connection W
4	U	Compressor connection U
5	V	Compressor connection V
6	-	Input port P_out for IPM module
7	-	Input port P_in for IPM module
8	CN23	Input port for high pressure switch
9	CN2	Power supply for switching power output
10	L1'	Power filtering L1
11	L2'	Power filtering L2
12	L3'	Power filtering L3
13	-	PED board
14	IC25	EEPROM

6.11 Filter module 6.1T - 7.1T - 8.1T

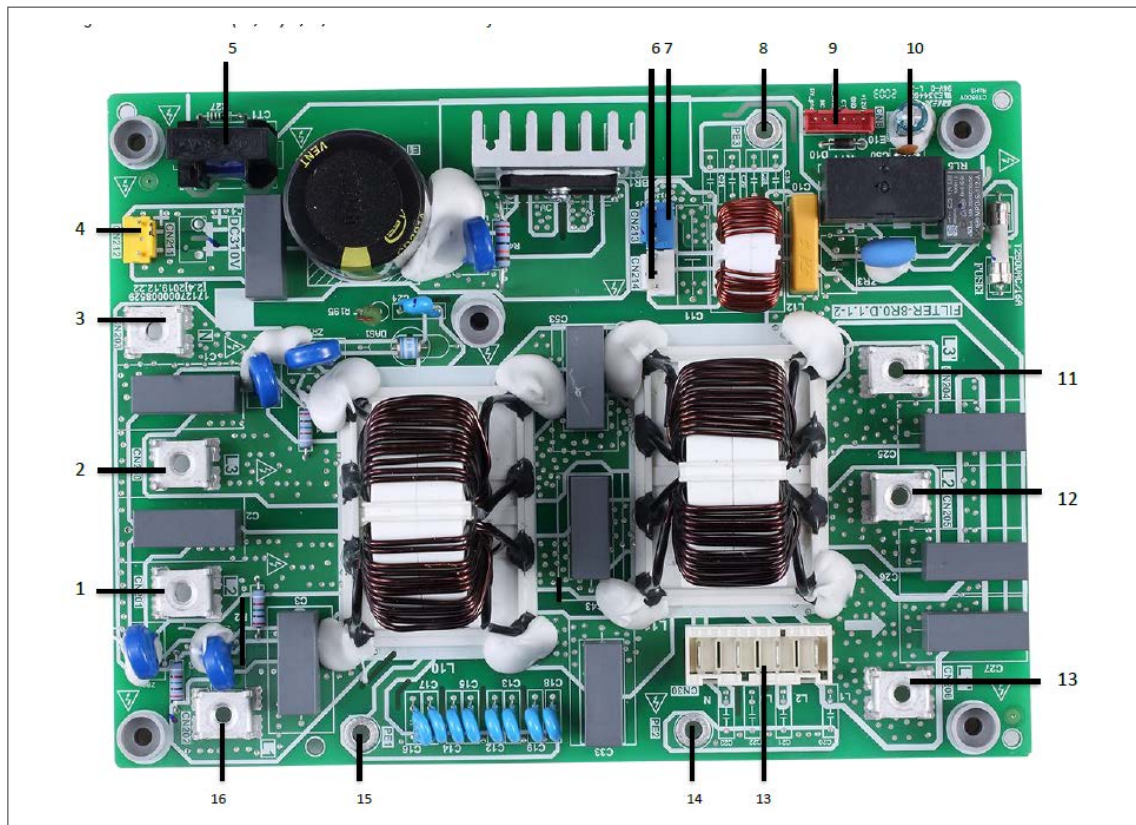

Rif	Sign	Description
1	CN201	Power supply L2
2	CN200	Power supply L3
3	CN203	Power supply N
4	CN212	310VDC power supply port
5	CN211	Power supply port for load
6	CN213	Port for FAN reactor
7	CN214	Power supply port for Inverter module
8	PE3	Earth wire
9	CN8	Port for communication with the FILTER BOARD
10	L3'	Power filtering L3
11	L2'	Power filtering L2
12	L1'	Power filtering L1
13	CN30	Power supply port for main control board
14	PE2	Earth wire
15	PE1	Earth wire
16	L1	Power supply L1

6.12 **Filter module - 9.1. - 10.1 - 12.1 - 14.1**

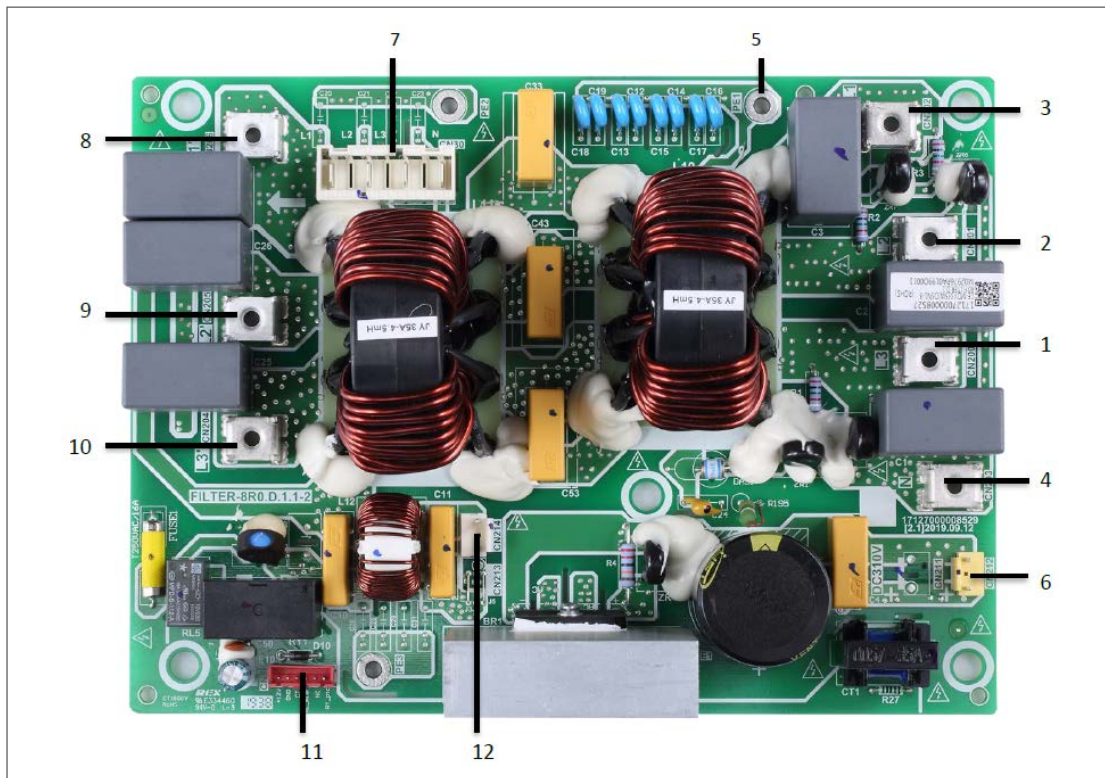

Rif	Sign	Description
1	L3	Power supply L3
2	L2	Power supply L2
3	L1	Power supply L1
4	N	Power supply N
5	PE1	Earth wire
6	CN212	Power supply port for DC fan
7	CN30	Power supply port for main control board
8	L1'	Power filtering L1
9	L2'	Power filtering L2
10	L3'	Power filtering L3
11	CN8	Port for communication with PCB B
12	CN214	Power output for PCB A switching power output

6.13 Display

Outdoor unit status	Parameters displayed on the hydronic system DSP1	Parameters displayed on the refrigerant system DSP1	
Waiting	0	0	
Normal operation	Outlet water temperature (°C)	Compressor operation speed in rotations per second	
Error or protection	Error or protection code	Error or protection code	

6.14 DIP Switch setting

The rotary switch S3(0-F) coded on the main control board of hydraulic module is used to set the Modbus address. By default, the units have this switch positioned=0, which corresponds to Modbus address 16, while the other positions correspond to the number, e.g. pos=2 is address 2, pos=5 is address 5

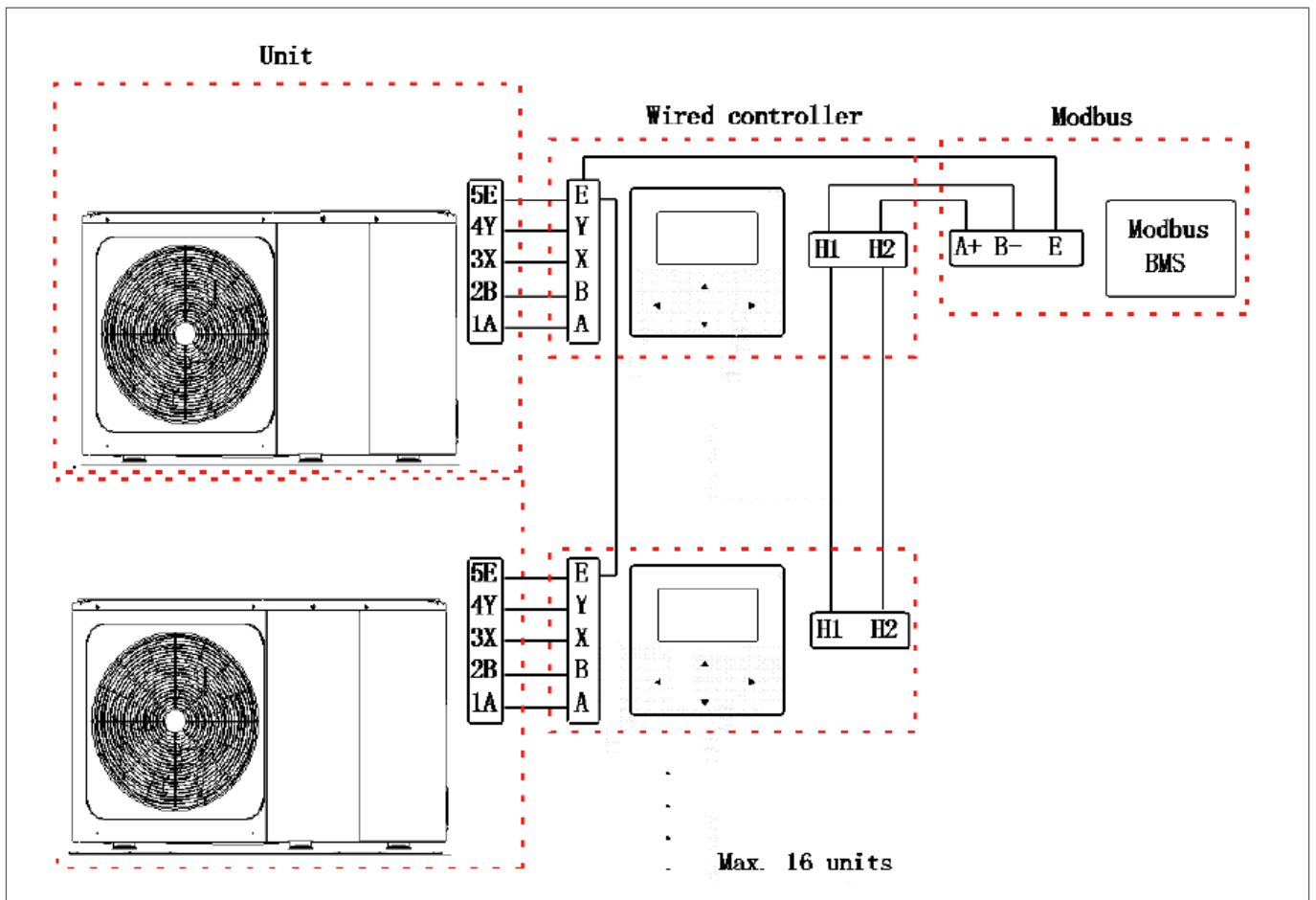
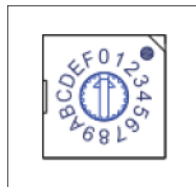

LAYOUT OF PCB BOARDS

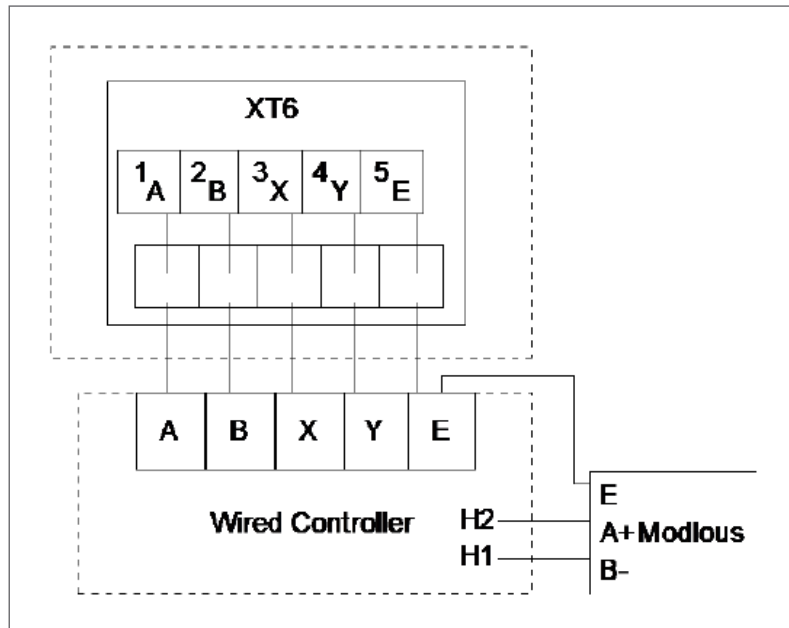

7. Table of error codes

C7	65	Transducer module temperature too high	
E0 E8	1 9	Water flow error (E8 is displayed 3 times)	
E1	2	Phase sequence error	Applies to three-phase models only
E2	3	Communication error between the user interface and the main control board of hydraulic module	
E3	4	Outlet water temperature sensor error	T1 sensor
E4	5	Domestic hot water tank temperature sensor error	T5 sensor
E5	6	Air side exchanger refrigerant outlet temperature sensor error	T3 sensor
E6	7	Outdoor ambient temperature sensor error	T4 sensor
E9	10	Suction pipe temperature sensor error	Th sensor
EA	11	Discharge pipe temperature sensor error	Tp sensor
Ed	14	Water side heat exchanger water inlet temperature sensor error	Tw_in sensor
EE	15	Hydronic box EEPROM error	
F1	116	DC generatrix voltage is too low	
H0	39	Communication error between outdoor unit main control chip and hydronic box main control chip	
H1	40	Communication error between outdoor unit main control chip and inverter driver chip	
H2	41	Water side plate heat exchanger refrigerant outlet (liquid pipe) temperature sensor error	T2 sensor
H3	42	Water side heat exchanger refrigerant inlet (gas pipe) temperature sensor error	T2B sensor
H5	44	Ambient temperature sensor error (HMI)	Ta sensor
H6 HH	45 55	DC fan error	
H7	46	Main circuit voltage fault	
H8	47	High pressure sensor error	
H9	48	Circuit 2 water outlet temperature sensor error	Tw2 sensor
HA	49	Water side exchanger water outlet temperature sensor error	Tw_out sensor
HF	54	Inverter module EEPROM error	
P0 HP	20 57	Low pressure protector	
P1	21	High pressure protection	
P3	23	Compressor current protection	
P4	24	Discharge temperature protection	

TABLE OF ERROR CODES

P5	25	High temperature difference between water side heat exchanger water inlet and water outlet temperatures protection	
P6 H4	26 43	Inverter module protection	
L0	-	Inverter module protection	
L1	-	DC bus low voltage protection	
L2	-	DC bus high voltage protection	
L4	-	MCE error	
L5	-	Zero speed protection	
L7	-	Phase sequence error	
L8	-	Compressor frequency variation greater than 15Hz within one second protection	
L9	-	Current compressor frequency differs from set frequency by more than 15 Hz protection	
Pb	31	Water side heat exchanger antifreeze	
Pd	33	High temperature protection of refrigerant outlet temperature of condenser in cooling mode	
PP	38	Water side heat exchanger inlet temperature is higher than outlet temperature in heating mode or DHW mode	
bH	112	PED board error	

8. Troubleshooting

E0, E8

Description

- Water flow error.
- E0 indicates that E8 has been displayed 3 times. When E0 error occurs, a manual system restart is required before the system can resume operation.
- The unit shuts down.
- The error code is displayed on the main PCB and user interface.

Possible causes

- The electric circuit has short-circuited or is open.
- Water flow is insufficient.
- The flow switch is damaged.
- The water circuit has not been properly vented
- The unit pump (Pump_) does not work

Procedure

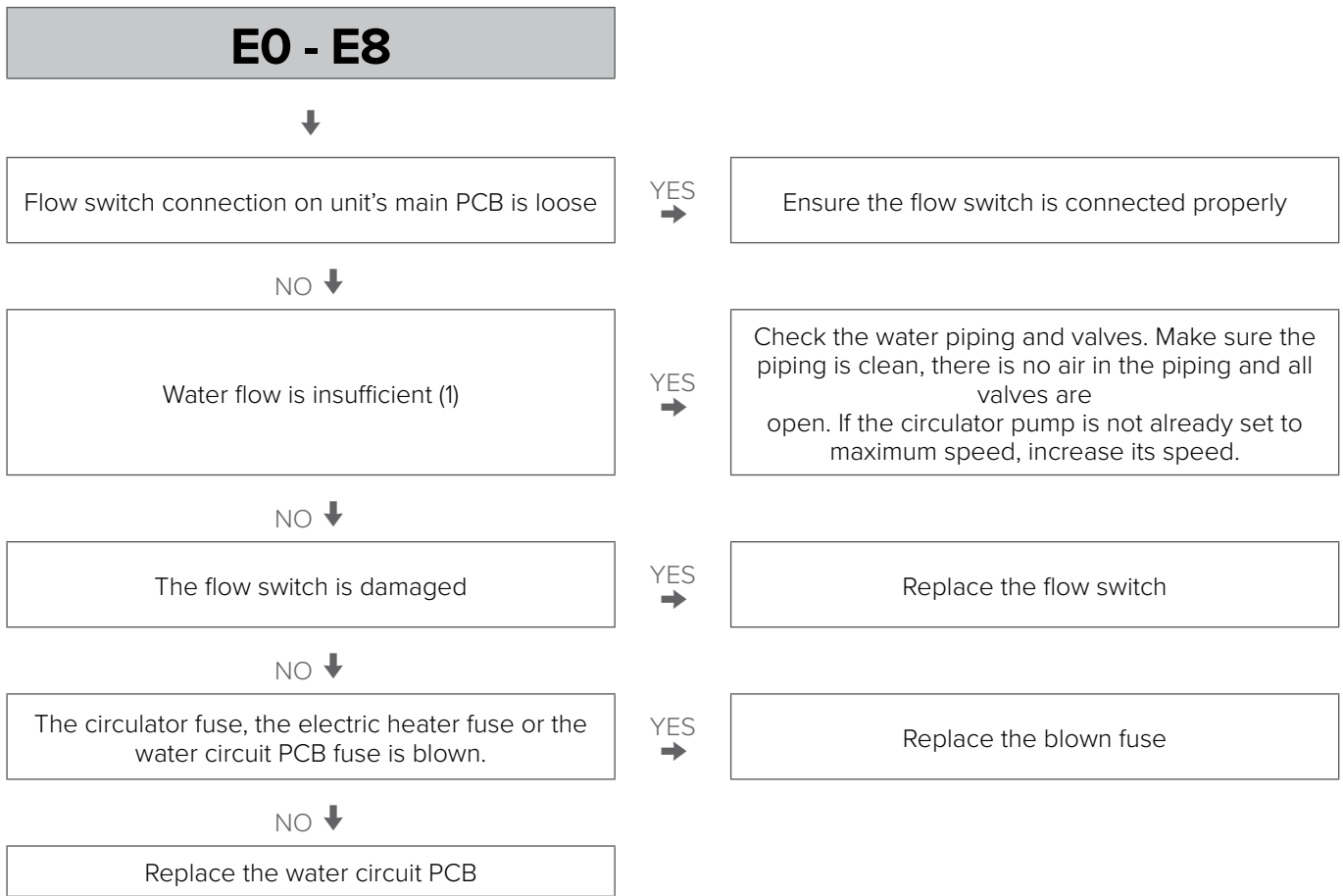

- 1 Measure sensor resistance. If the resistance is too low, the sensor has short-circuited. If the resistance is not consistent with the sensor's resistance characteristics table, the sensor has failed.
- 2 The flow switch connection is port CN8 on the main PCB.
- 3 Check water pressure on the pressure gauge. If the pressure is not >1 bar, the flow is insufficient

E1

Description

Phase sequence error.

Applies to three-phase models only.

The unit shuts down.

The error code is displayed on the main PCB and user interface.

Possible causes

Power supply phases not connected in the correct sequence.

Loosened power supply terminals.

Abnormal power supply.

Main PCB is damaged.

Procedure

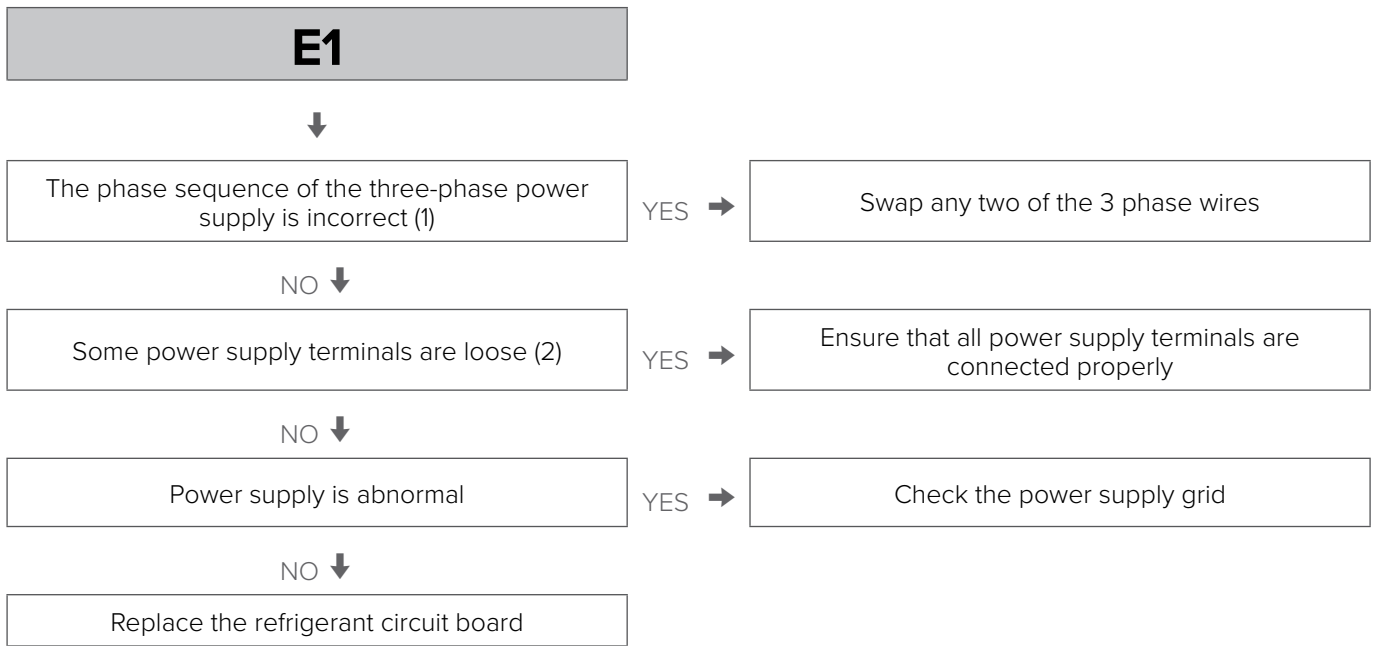

- 1 Terminals A, B, C of the three-phase power supply must correspond to the requirements of the compressor phase sequence. If the phase sequence is reversed, the compressor will operate in reverse. If the wiring connection of each outdoor unit is in the A, B, C phase sequence and more units are connected, the current difference between phase C and phases A and B will be very significant, as the power supply load of each outdoor unit will be on phase C. In this case, it is easy for the circuits to jump and the terminals to burn out. So if more than one unit is to be used, the phase sequence must be staggered so that the current is distributed equally between the three phases.
- 2 Loose power supply terminals can cause compressors to operate abnormally with very high compressor current.

E2

Description

Communication error between unit and user interface.

The unit shuts down.

The error code is displayed on the main PCB and user interface.

Possible causes

Communication wires between unit and user interface not connected properly.

Communication wiring X Y E terminals disconnected.

Loosened wiring inside the electric control box.

Interference from high voltage wires or other sources of electromagnetic radiation.

Damaged main PCB or electric control box communication terminals block.

TROUBLESHOOTING

Procedure

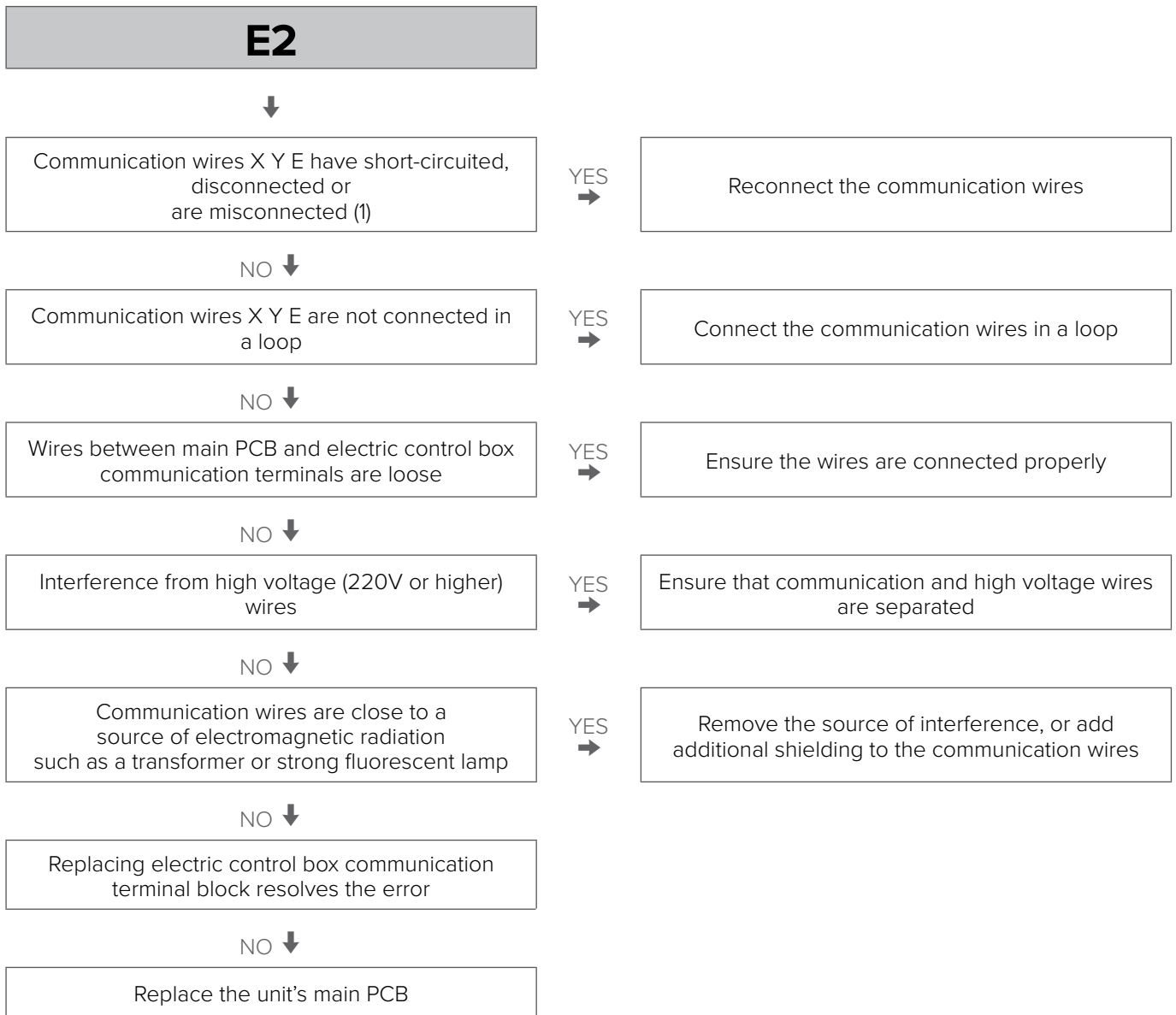

1 Measure resistance between X Y E. Normal resistance between X and Y is 120Ω. Communication wiring has polarity. Ensure wire X is connected to terminal X, etc.

E3, E4, Ed, H3, H5, HA, H9, Ec, E7

Description

E3 indicates a backup electric heater water outlet temperature sensor error (T1)

E4 indicates a domestic hot water tank temperature sensor error (T5)

H3 indicates a water side exchanger refrigerant inlet (liquid pipe) temperature sensor error (T2)

Ed indicates a water side heat exchanger water inlet temperature sensor error (Tw_in)

HA indicates a water side heat exchanger water outlet temperature sensor error (Tw_out)

H5 indicates an ambient temperature sensor error (Ta)

H9 indicates a low temperature circuit water outlet temperature sensor error (T1B)

Eb indicates a solar option temperature sensor error (Tsolar)

E7 indicates an inertial tank temperature sensor error (Tbt1)

Ec indicates an additional DHW tank temperature sensor error (T5_2/Tbt2)

The unit shuts down.

The error code is displayed on the main PCB and user interface.

Possible causes

Temperature sensor not connected properly or is malfunctioning.

Main PCB is damaged.

Procedure

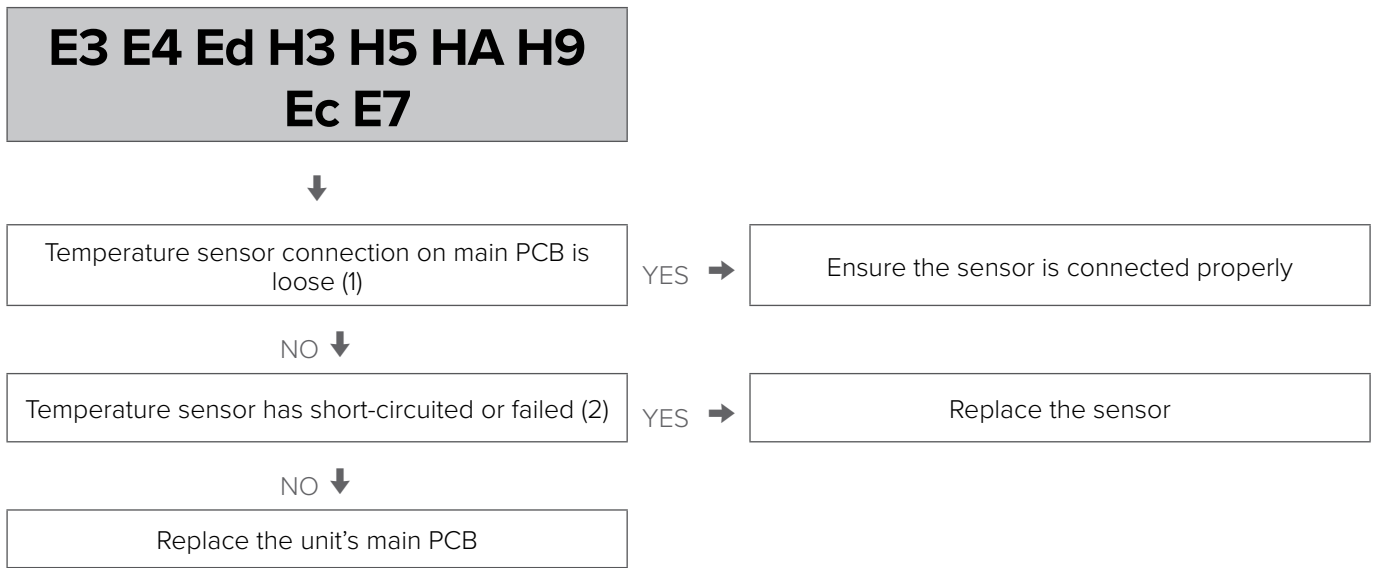

- 1 End water outlet temperature sensor, water side exchanger refrigerant inlet (liquid pipe) temperature sensor, water side exchanger refrigerant outlet (gas pipe) temperature sensor, water side exchanger water inlet temperature sensor and water side exchanger water outlet temperature sensor connections are port CN6 on the unit's main PCB. Domestic hot water tank temperature sensor connection is port CN13 on the unit's main PCB. Circuit 2 water outlet temperature sensor connection is port CN15 on the unit's main PCB. Ambient temperature sensor connection is port CN11 on the unit's main PCB. Solar panel temperature sensor connection is port CN18 on the unit's main PCB. Inertial tank temperature sensor connection is port CN24 on the unit's main PCB. DHW tank temperature sensor connection is port CN16 on the unit's main PCB.
- 2 Measure sensor resistance. If the resistance is too low, the sensor has short-circuited. If the resistance is not consistent with the sensor's resistance characteristics table, the sensor has failed. Refer to the "Temperature sensor resistance characteristics" table.

E5, E6, E9, EA

Description

E5 indicates an air side heat exchanger refrigerant outlet temperature sensor error.

E6 indicates an outdoor ambient temperature sensor error.

E9 indicates a suction pipe temperature sensor error.

EA indicates a discharge temperature sensor error.

The unit shuts down.

The error code is displayed on the main PCB and user interface.

Possible causes

Temperature sensor not connected properly or has malfunctioned.

Main PCB is damaged.

Procedure

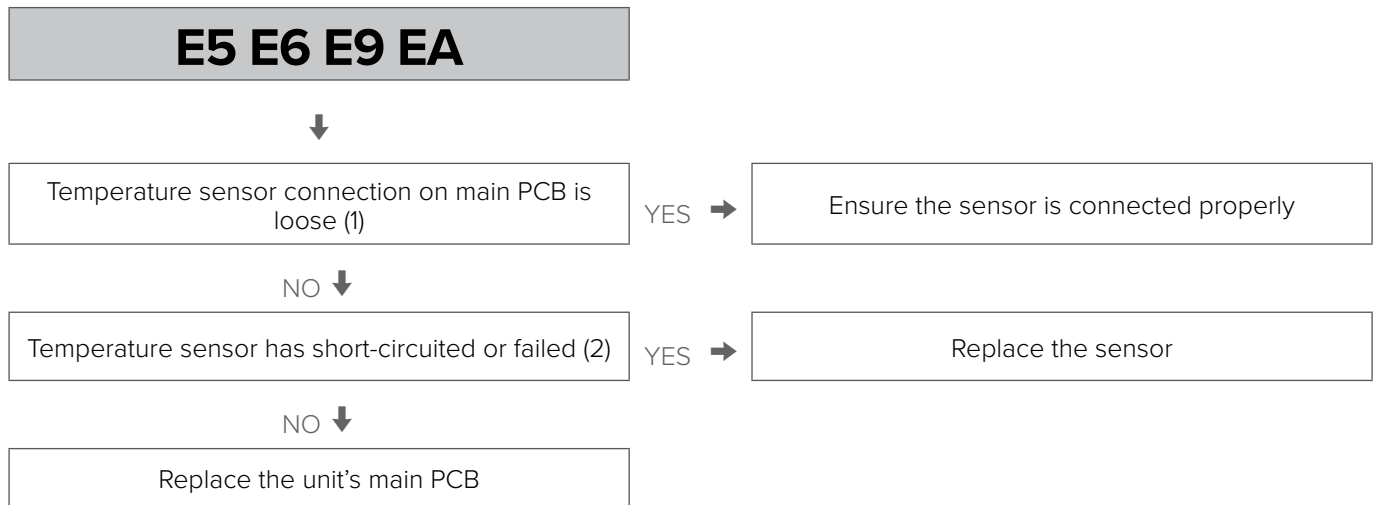

- 1 Air side exchanger refrigerant outlet temperature sensor and outdoor ambient temperature sensor connections are port CN9 on the unit's main PCB. Discharge pipe temperature sensor connection is port CN8 on the single-phase unit's main PCB and CN4 on the three-phase unit's main PCB.
- 2 Measure sensor resistance. If the resistance is too low, the sensor has short-circuited. If the resistance is not consistent with the sensor's resistance characteristics table, the sensor has failed. Refer to the "Temperature sensor resistance characteristics" table.

EE

Description

Unit main PCB EEPROM error.

The unit shuts down.

The error code is displayed on the main PCB and user interface.

Possible causes

The main PCB EEPROM is not connected properly.

Main PCB is damaged.

Procedure

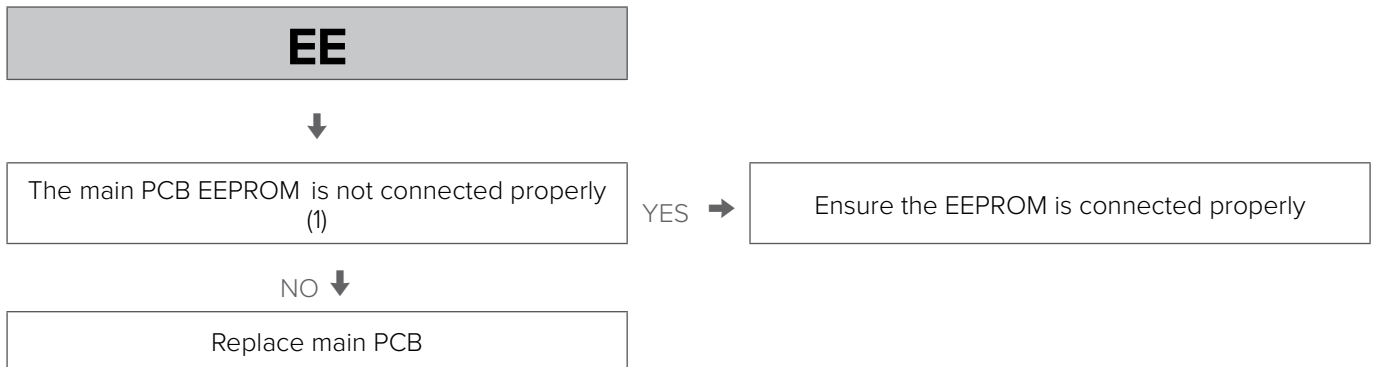

1 Hydronic system main PCB EEPROM is assigned on hydronic system main PCB.

F1

Description

Low DC generatrix voltage.

The unit shuts down.

The error code is displayed on the main PCB and user interface.

Possible causes

DC generatrix voltage is too low

Procedure

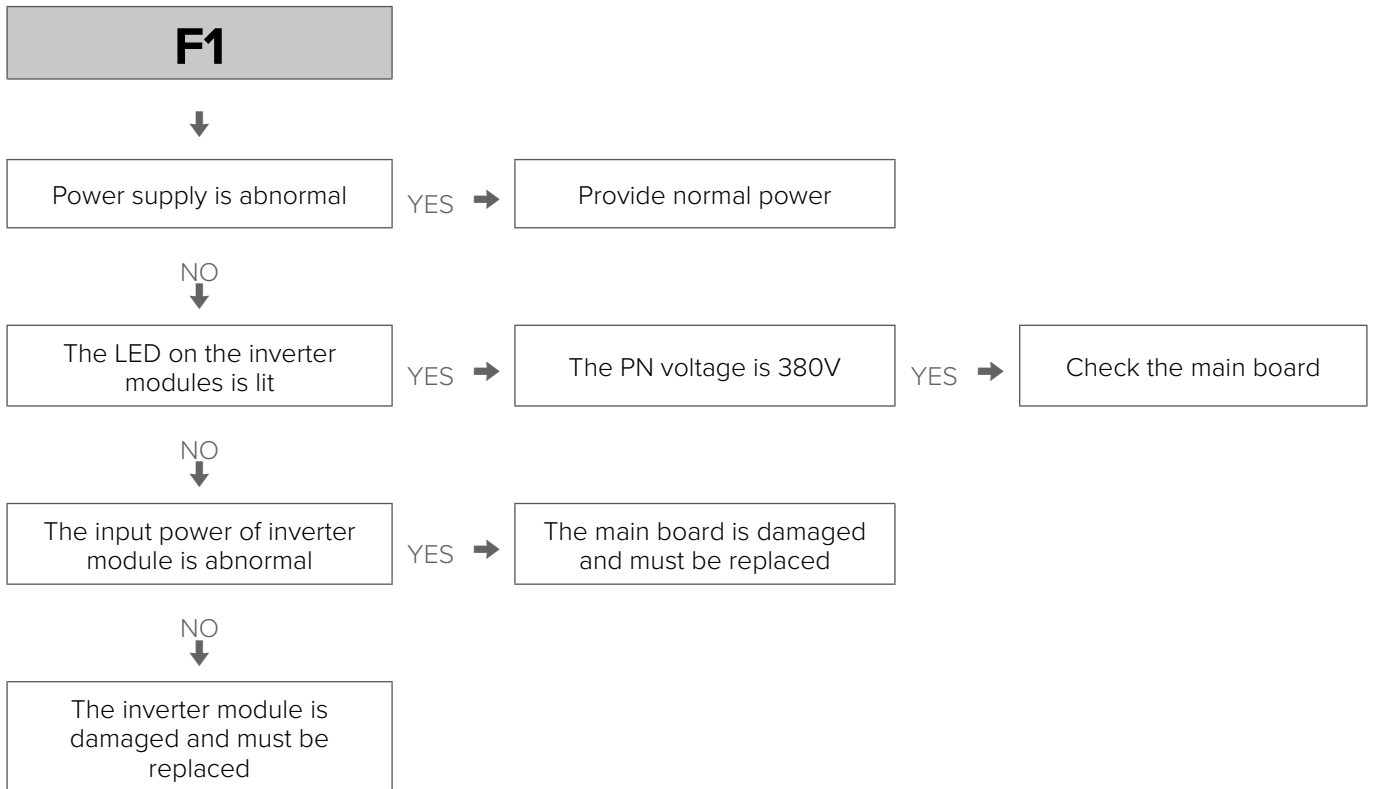

HF

Description

Main PCB EEPROM error.

The unit shuts down.

The error code is displayed on the main PCB and user interface.

Possible causes

The main PCB EEPROM is not connected properly.

Main PCB is damaged.

Procedure

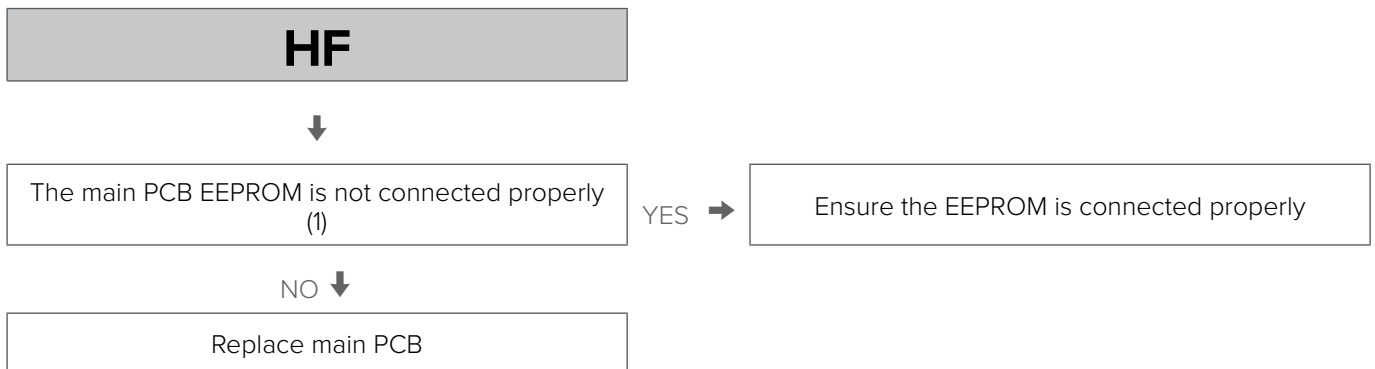

1 The unit EEPROM is assigned IC320 on single-phase unit WiSAN-YME 1 S 2.1 - 5.1, assigned IC14 on single-phase unit WiSAN-YME 1 S 6.1-8.1 and assigned IC25 on unit WiSAN-YME 1 S 6.1T-14.1

H0

Description

- Communication error between the main PCB and the hydronic system PCB.
- The unit shuts down.
- The error code is displayed on the hydronic system PCB, refrigerant circuit PCB and user interface.

Possible causes

Abnormal power supply.

Transformer malfunction.

Interference from a source of electromagnetic radiation.

Main PCB or hydronic system PCB damaged.

Procedure

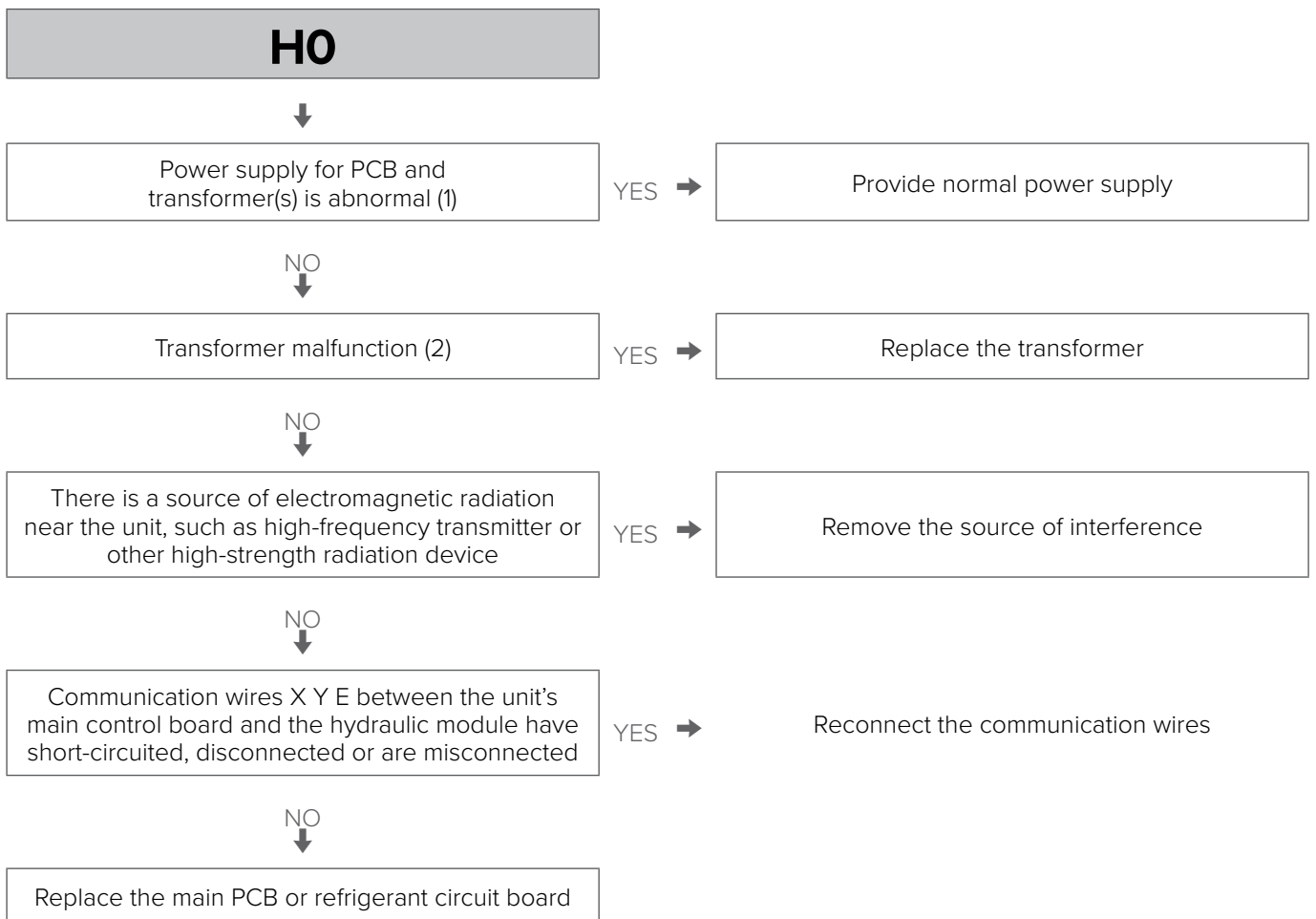

- 1 Measure the voltages of transformer input port and on main PCB. The normal transformer voltage for units WiSAN-YME 1 S 2.1-8.1T is 220V input and 18V output. The normal transformer voltage for units WiSAN-YME 1 S 9.1-14.1 is 220V input and 13.5V output. If one or more of the voltages is not normal, the power supply of the refrigerating system's main control board and transformer is abnormal.
- 2 Measure the voltages of transformer output ports. If the voltages are not normal, the transformer has failed.

H1

Description

Communication error between main control board and inverter module.

The unit shuts down.

The error code is displayed on the main PCB and user interface.

Possible causes

Abnormal power supply.

Transformer malfunction

Interference from a source of electromagnetic radiation.

Main PCB or inverter driven module damaged.

Procedure

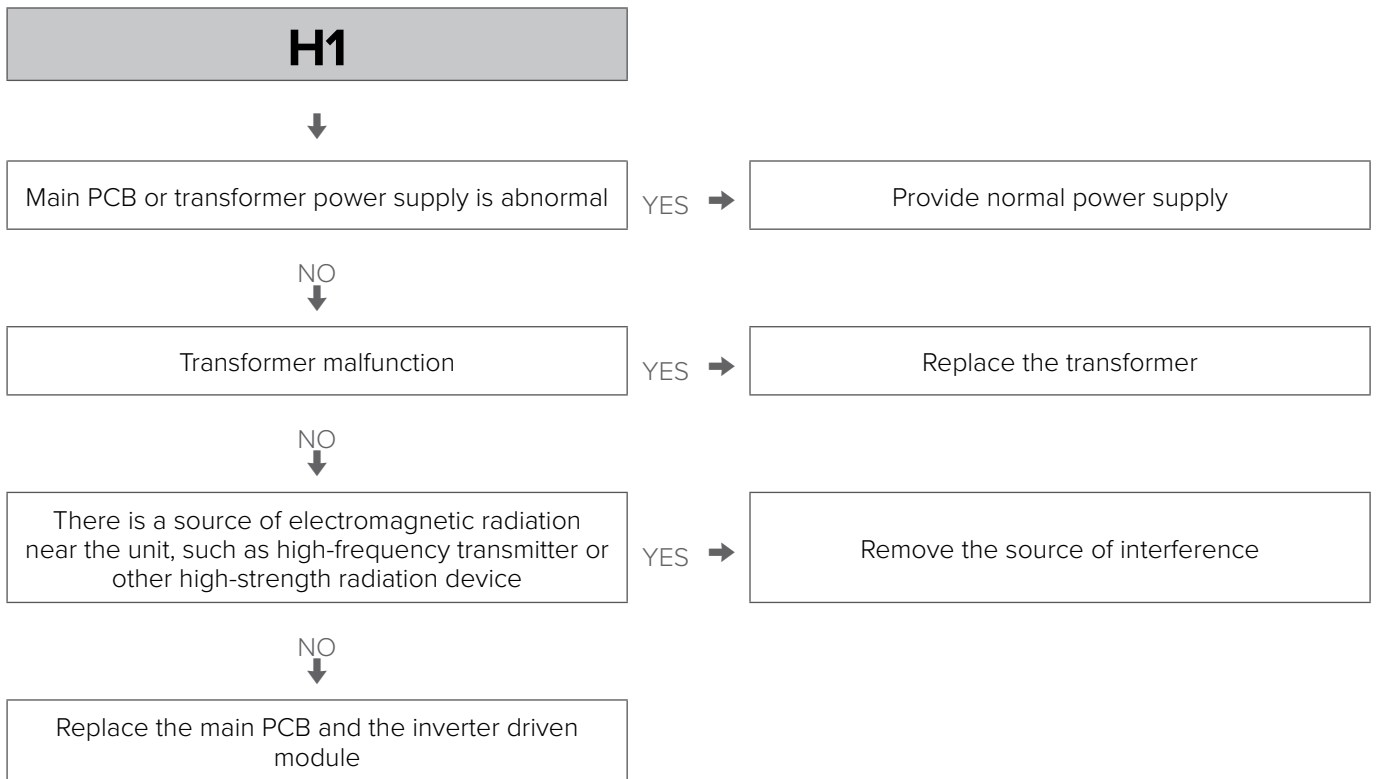

H6, HH

Description

- H6 indicates a DC fan error.
- HH indicates that H6 protection has occurred 10 times in 2 hours. When HH error occurs, a manual system restart is required before the system can resume operation. The cause of HH error should be addressed promptly in order to avoid system damage.
- The unit shuts down.
- The error code is displayed on the main PCB and user interface.

Possible causes

- Fan communication or controller wiring is not connected properly.
- High wind speed.
- Fan motor blocked or failed.
- Abnormal power supply.
- Inverter module damaged.
- Main PCB is damaged.

Procedure

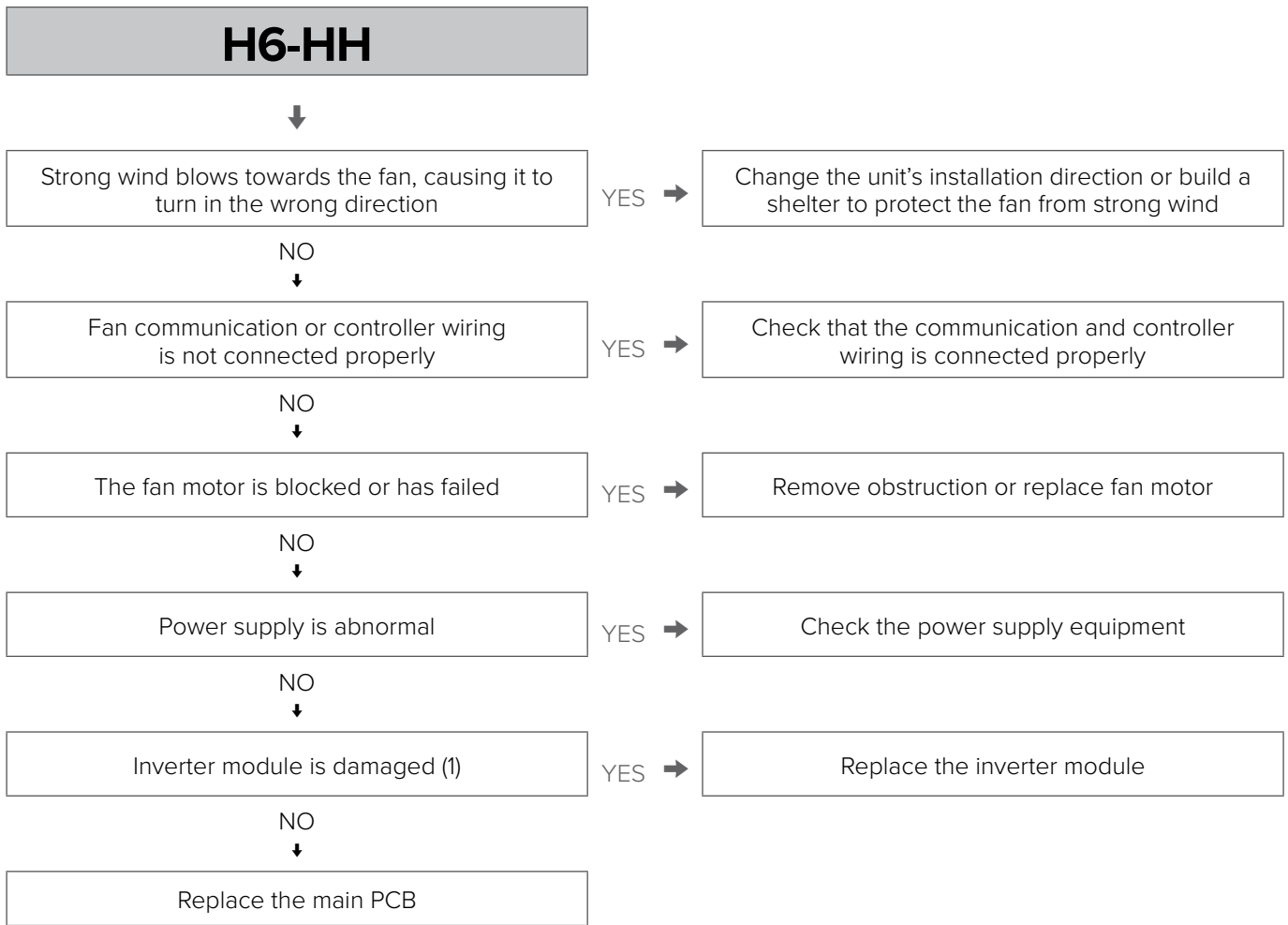

1 Measure the voltage between the black and white wires of the DC fan motor power output. The normal voltage is 15V when the unit is in standby. If the voltage is significantly different from 15V, the IPM module on the inverter module is damaged.

H7

Description

- Abnormal main circuit voltage.
- The unit shuts down.
- The error code is displayed on the main PCB and user interface.

Possible causes

- Power supply voltage not within $\pm 10\%$ of the rated voltage or a phase is missing.
- Unit switched on immediately after being switched off.
- Loosened wiring inside the electric control box.
- High voltage circuit error.
- Main PCB is damaged.

Procedure

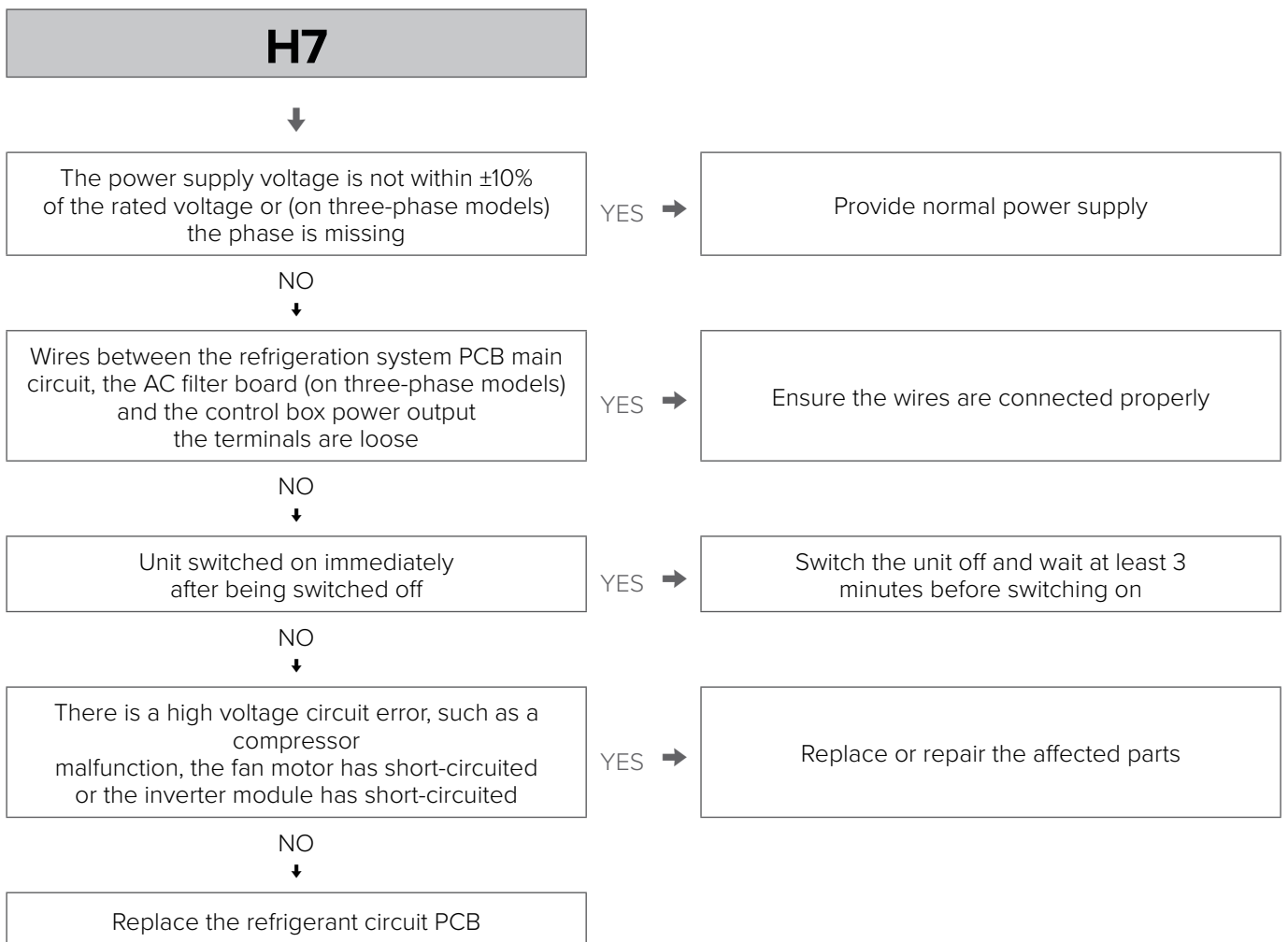

H8

Description

- High pressure sensor error
- The unit shuts down.
- The error code is displayed on the main PCB and user interface.

Possible causes

- Temperature sensor not connected properly or has malfunctioned.
- The main PCB is damaged.

Procedure

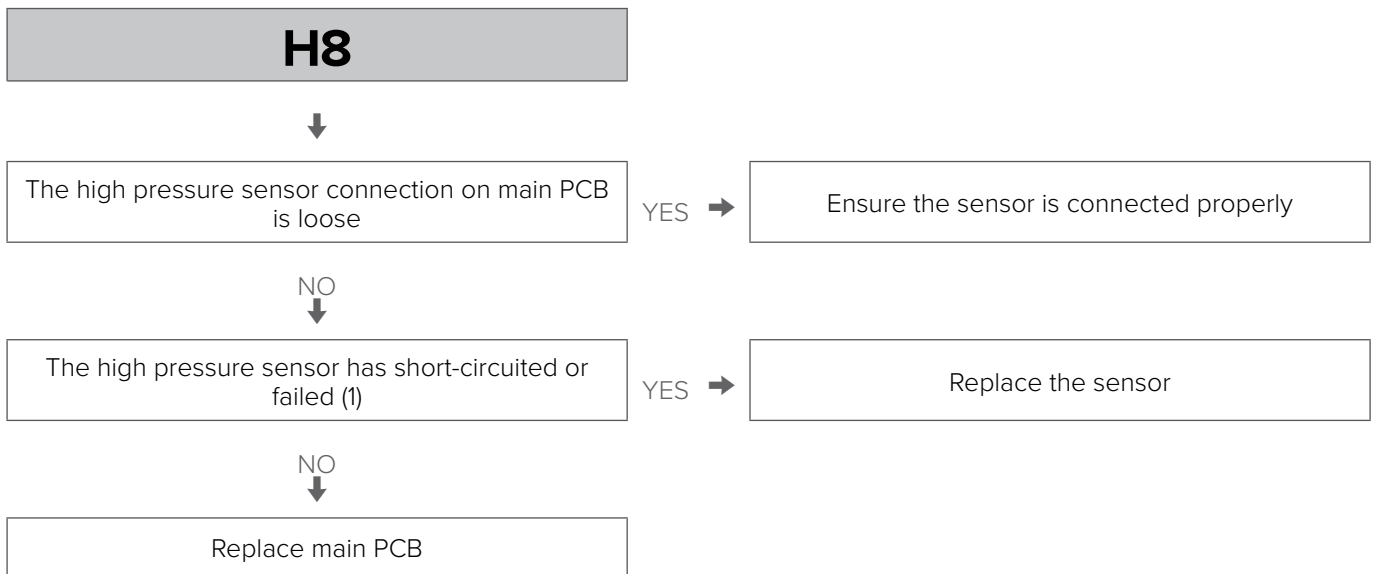

1 Measure the resistance among the three terminals of the pressure sensor. If the resistance is of the order of mega Ohms or infinite, the pressure sensor has failed.

P0, HP

Description

- P0 indicates suction pipe low pressure protection. When the suction pressure falls below 0.14 MPa, the system displays P0 protection and the unit shuts down. When the pressure rises above 0.3 MPa, P0 is removed and normal operation resumes.
- HP indicates that P0 protection has occurred 3 times in 60 minutes. When an HP error occurs, a manual system restart is required before the system can resume operation.
- The error code is displayed on the main PCB and user interface.

Possible causes

- Low pressure switch not connected properly or has malfunctioned.
- Insufficient refrigerant. Possible refrigerant leak in the refrigerant circuit.
- Low pressure side blockage.
- Poor evaporator heat exchange in heating mode or DHW mode.
- Insufficient water flow in cooling mode.
- Main PCB is damaged.

TROUBLESHOOTING

Procedure

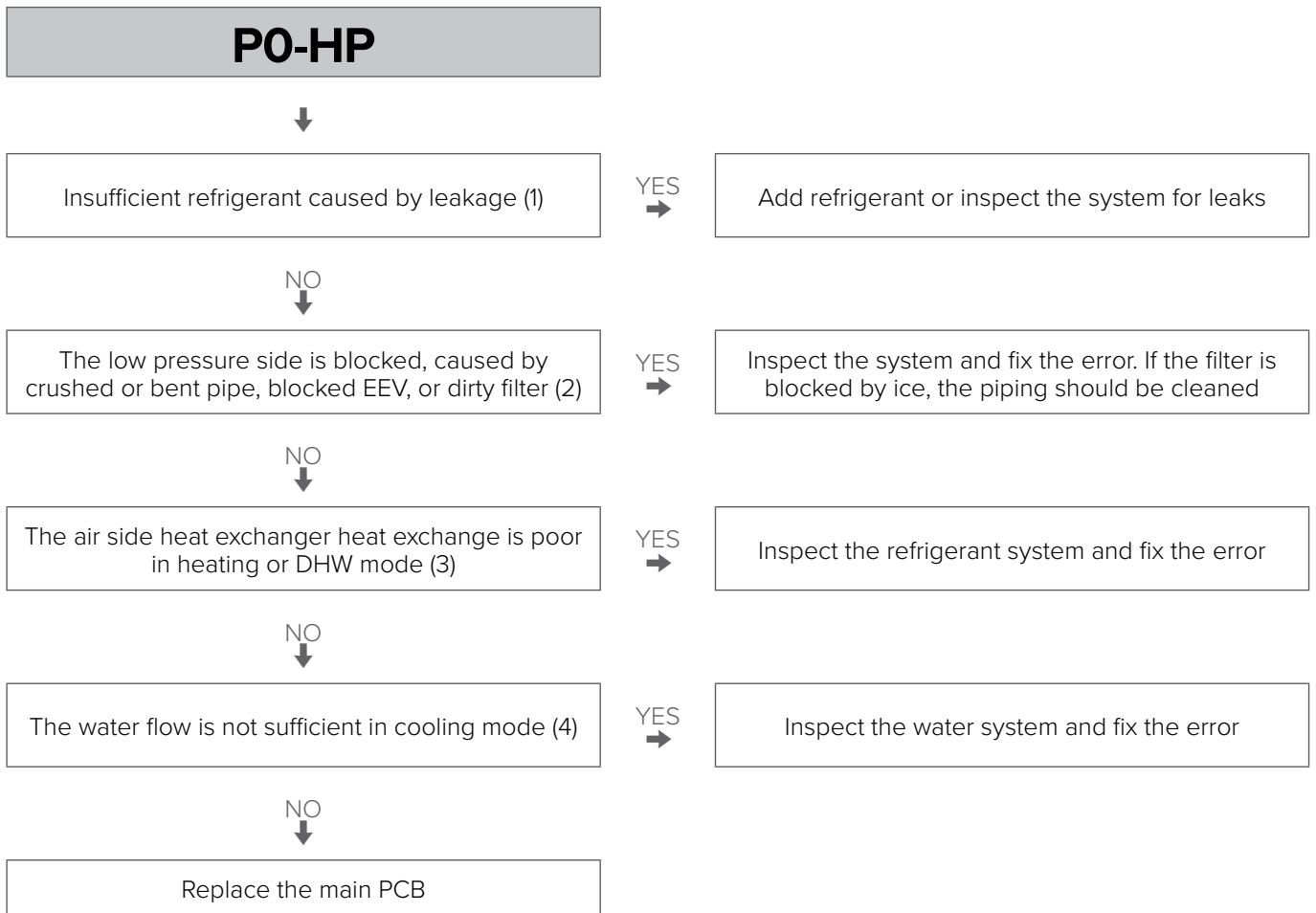

- 1 To check for insufficient presence of refrigerant: An insufficiency of refrigerant causes compressor discharge temperature to be higher than normal, discharge and suction pressures to be lower than normal and compressor current to be lower than normal, and may cause frosting to occur on the suction pipe. These issues disappear once a sufficient amount of refrigerant has been charged into the system.
- 2 A low pressure side blockage causes compressor discharge temperature to be higher than normal, suction pressure to be lower than normal and compressor current to be lower than normal, and may cause frosting to occur on the suction pipe compared to normal system parameters.
- 3 Check air side heat exchanger, fan and air outlets for dirt/blockages.
- 4 Check water side heat exchanger, water piping, circulator pumps and water flow switch for dirt/blockages.

P1

Description

- Discharge piping system high pressure protection. When the discharge pressure rises above 4.3 MPa, the system displays P1 protection and the unit shuts down. When the discharge pressure falls below 3.6 MPa, P1 is removed and normal operation resumes.
- The error code is displayed on the main PCB and user interface.

Possible causes

- Pressure sensor/switch not connected properly or has malfunctioned.
- Excess refrigerant.
- System contains air or nitrogen.
- High pressure side blockage.
- Poor condenser heat exchange.
- Main PCB is damaged.

Procedure

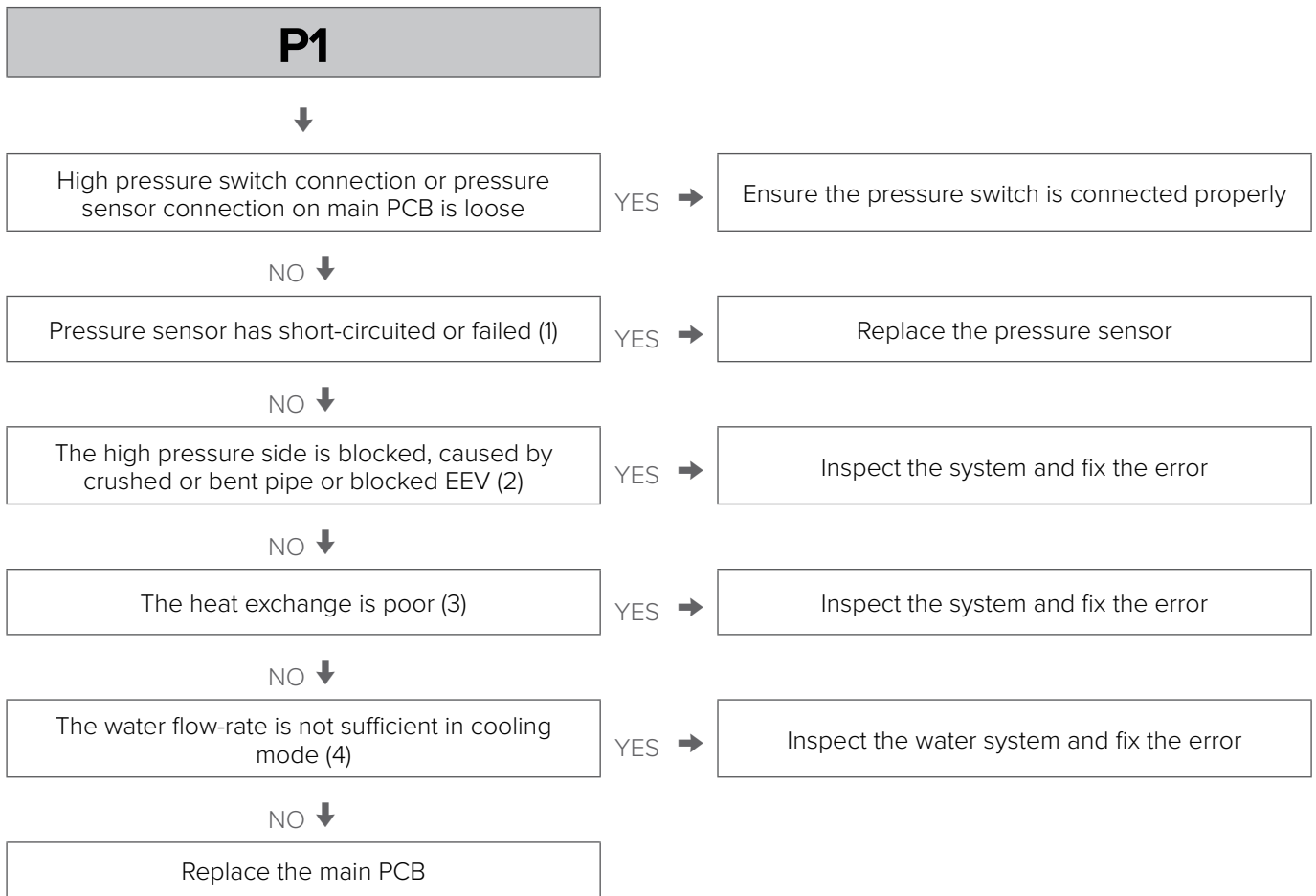

- 1 Measure the resistance among the three terminals of the pressure sensor. If the resistance is of the order of mega Ohms or infinite, the pressure sensor has failed.
- 2 High pressure side blockage causes discharge temperature to be higher than normal, discharge pressure to be higher than normal and suction pressure to be lower than normal.
- 3 In heating mode check water side heat exchanger, water piping, circulator pumps and water flow switch for dirt/blockages. In cooling mode check air side heat exchanger, fans and air outlets for dirt/blockages.
- 4 Check water pressure on the pressure gauge. If the water pressure is not > 1 bar, the flow is insufficient
- 5 The high pressure switch connection is port CN13 on single-phase units and port CN31 on three-phase units.

P3

Description

- Compressor current protection.
- When the compressor current rises above the protection value, the system displays P3 protection and the unit shuts down. When the current returns to the normal range, P3 is removed and normal operation resumes.
The protection values for the units are:
 - WiSAN-YME 1 S 2.1-3.1 - 18A
 - WiSAN-YME 1 S 4.1-5.1 - 19A
 - WiSAN-YME 1 S 6.1-8.1 - 30A
 - WiSAN-YME 1 S 6.1T-8.1T - 14A
 - WiSAN-YME 1 S 9.1-14.1 - 28A
- The error code is displayed on the main PCB and user interface.

Possible causes

- Abnormal power supply
- Poor condenser heat exchange.
- High pressure side blockage.
- Inverter module damaged.
- Compressor damaged.
- Main PCB is damaged.

Procedure

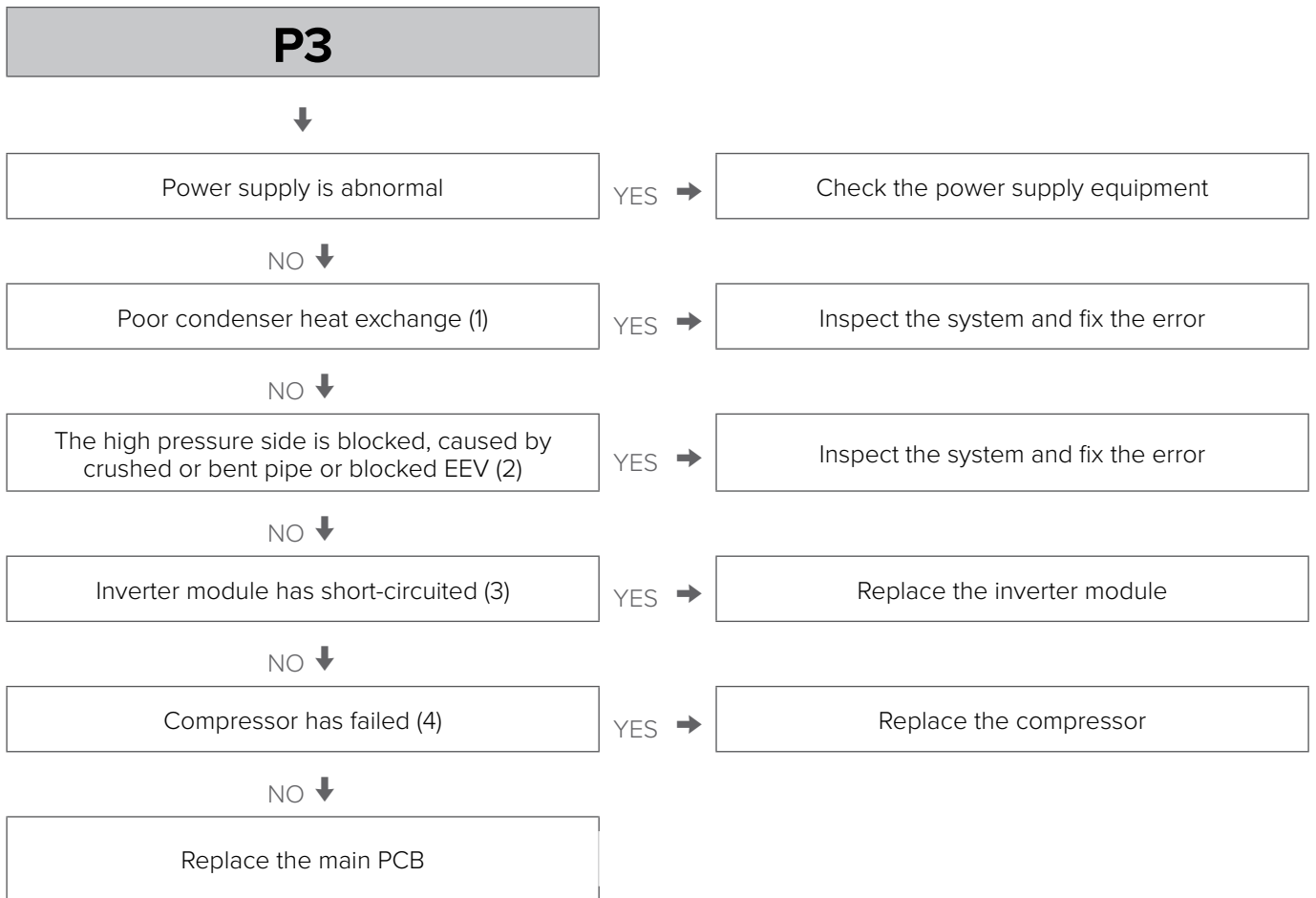

- 1 In heating mode check water side heat exchanger, water piping, circulator pumps and water flow switch for dirt/blockages. In cooling mode check air side heat exchanger, air outlets and fans for dirt/blockages.
- 2 High pressure side blockage causes discharge temperature to be higher than normal, discharge pressure to be higher than normal and suction pressure to be lower than normal.
- 3 Set a multi-meter to buzzer mode and test any two terminals of P N and U V W of the inverter module. If the buzzer sounds, the inverter module has short-circuited
- 4 The normal resistances of the inverter compressor are 0.7-1.5Ω among U V W and infinite between each of U V W and grounding. If any of the resistances differ from these specifications, the compressor has malfunctioned.

P4

Description

- Discharge temperature protection
- When the compressor discharge temperature rises above 115°C, the system displays P4 protection and the unit shuts down. When the discharge temperature falls below 95°C, P4 is removed and normal operation resumes.
- The error code is displayed on the main PCB and user interface.

Possible causes

- Temperature sensor error
- High pressure side blockage.
- Poor condenser heat exchange.
- Main PCB is damaged.

TROUBLESHOOTING

Procedure

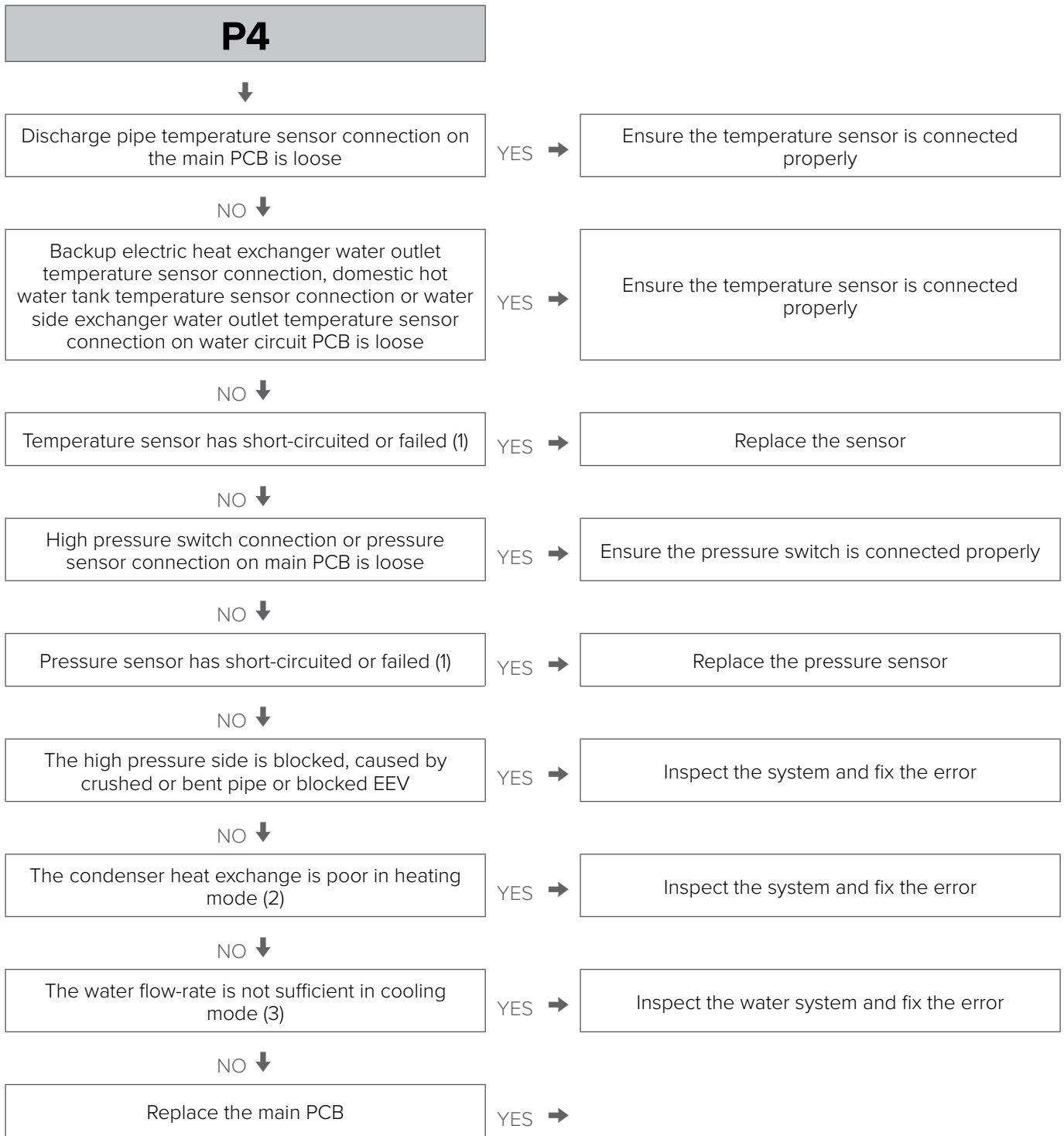

- 1 Measure sensor resistance. If the resistance is too low, the sensor has short-circuited. If the resistance is not consistent with the sensor's characteristics table, the sensor has failed.
- 2 Measure the resistance among the three terminals of the pressure sensor. If the resistance is of the order of mega Ohms or infinite, the pressure sensor has failed
- 3 High pressure side blockage causes discharge temperature to be higher than normal, discharge pressure to be higher than normal and suction pressure to be lower than normal

P5

Description

- High temperature difference between water side heat exchanger water inlet and water outlet temperatures protection.
- The unit shuts down.
- The error code is displayed on the main PCB and user interface.

Possible causes

- Temperature sensor not connected properly or has failed.
- Water piping contains air.
- Insufficient water flow.
- Water circuit PCB damaged.

TROUBLESHOOTING

Procedure

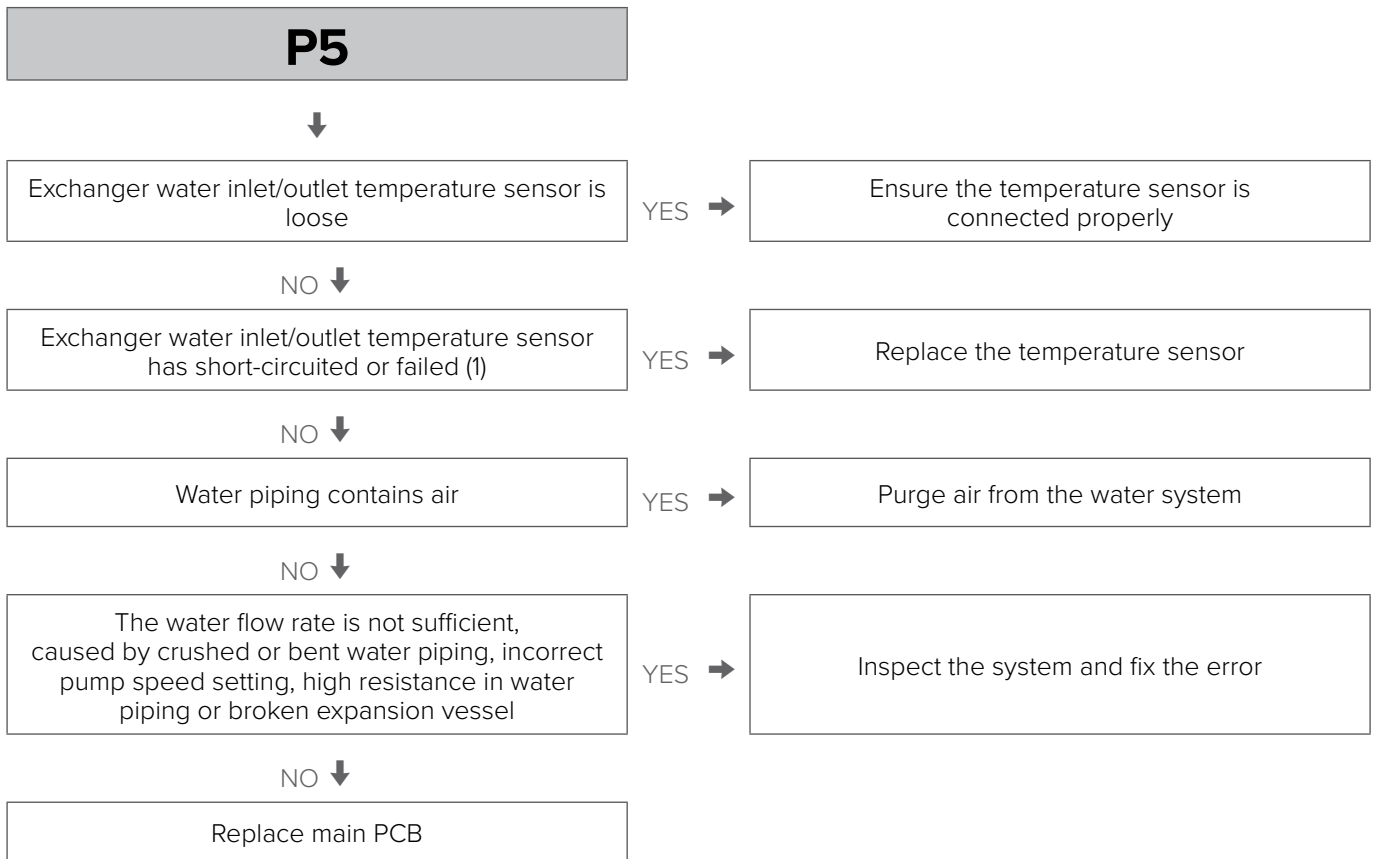

1 Measure sensor resistance. If the resistance is too low, the sensor has short-circuited. If the resistance is not consistent with the sensor's resistance characteristics table, the sensor has failed.

L0, L1, L2, L4, L5, L8, L9 - SINGLE-PHASE units

Description

Inverter module protection

The unit shuts down.

Specific error code L0, L1, L2, L4, L5, L7, L8 or L9 is displayed on the main PCB and user interface.

Possible causes

Inverter module protection

DC bus low or high voltage protection.

MCE error (Bus low or high voltage protection or overcurrent protection **)

Zero speed protection.

Phase sequence error.

Excessive compressor frequency variation.

High pressure protector

PED board auto-control error

Specific error codes for inverter module protection

Error code	Description
L0	inverter module protection
L1	DC bus low voltage protection
L2	DC bus high voltage protection
L4	MCE error (**)
L5	zero speed protection
L8	compressor frequency variation greater than 15 Hz within one second protection
L9	current compressor frequency differs from set frequency by more than 15 Hz protection

The specific error codes can also be obtained from the LED indicators on the inverter module.

Inverter module 2.1-3.1-4.1-5.1

LED301 flashing pattern (green) LED302 always on (red)	Corresponding error
Flashes 8 times and stops for 1 second, then resumes.	L0 - inverter module protection
Flashes 9 times and stops for 1 second, then resumes	L1 - DC bus under-voltage protection
Flashes 10 times and stops for 1 second, then resumes.	L2 - DC bus overvoltage protection
Flashes 12 times and stops for 1 second, then resumes.	L4 - MCE error
Flashes 13 times and stops for 1 second, then resumes.	L5 - zero speed protection L5
Flashes 15 times and stops for 1 second, then resumes.	L7 - phase sequence error
Flashes 16 times and stops for 1 second, then resumes	L8 - compressor frequency variation greater than 15 Hz within one second protection

TROUBLESHOOTING

Flashes 17 times and stops for 1 second, then resumes	L9 - current compressor frequency differs from set frequency by more than 15 Hz protection
---	--

LED position

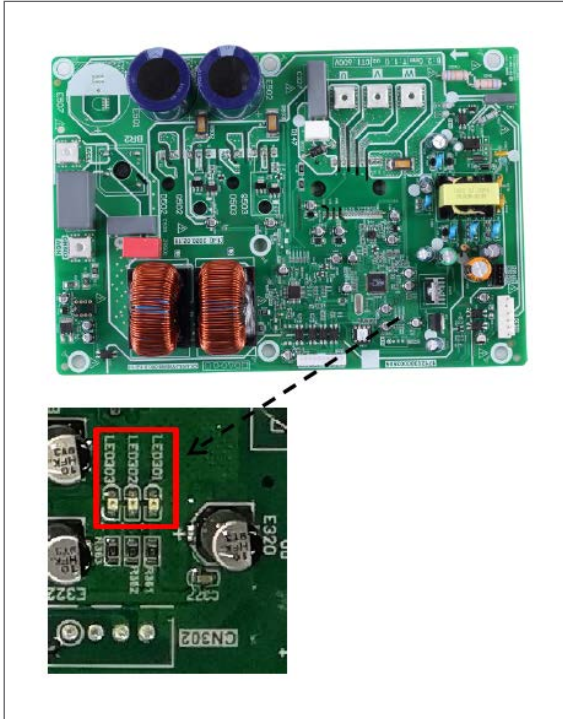

Inverter module 6.1-7.1-8.1

LED1 flashing pattern (green) LED2 always on (red)	Corresponding error
Flashes 3 times and stops for 1 second, then resumes.	P1 - high pressure protector
Flashes 5 times and stops for 1 second, then resumes	bH - PED board check failed
Flashes 8 times and stops for 1 second, then resumes.	L0 - inverter module protection
Flashes 9 times and stops for 1 second, then resumes.	L1 - DC bus under-voltage protection
Flashes 10 times and stops for 1 second, then resumes.	L2 - DC bus overvoltage protection
Flashes 12 times and stops for 1 second, then resumes.	L4 - MCE error
Flashes 13 times and stops for 1 second, then resumes	L5 - zero speed protection L5
Flashes 16 times and stops for 1 second, then resumes	L8 - compressor frequency variation greater than 15 Hz within one second protection
Flashes 17 times and stops for 1 second, then resumes	L9 - current compressor frequency differs from set frequency by more than 15 Hz protection

LED position

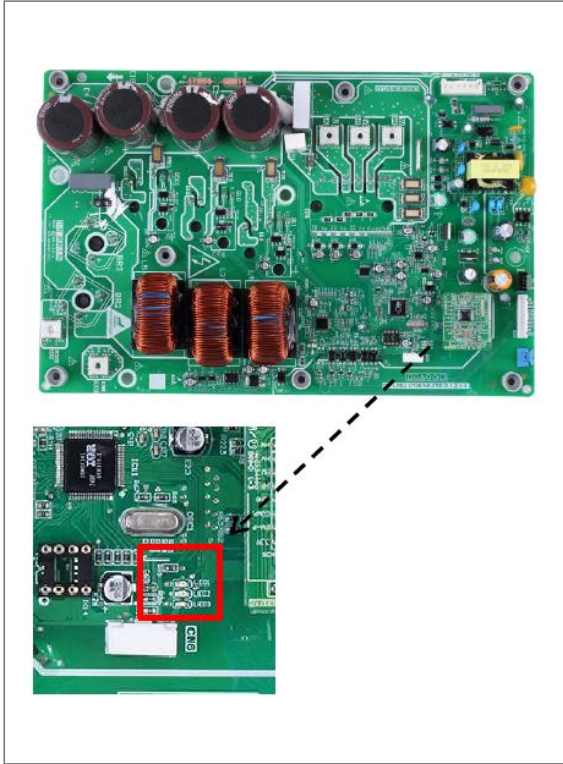

Principle of DC inverter

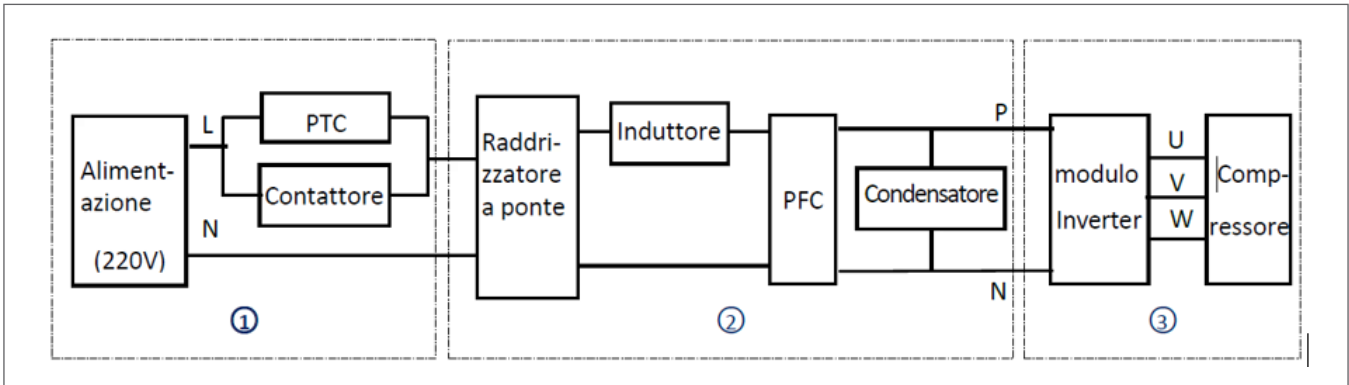

- 1 The contactor is open, current across the PTC to charge the capacitor, after 5 seconds the contactor closes.
- 2 220/240V AC power supply changes to DC power supply after bridge rectifier
- 3 The capacitor's steady output power supply for inverter module P N terminals. In standby the voltage between P and N terminals on inverter module is 1.4 times the AC power supply. When the fan motor is in operation, the voltage between P and N terminals on inverter module is 377 V DC.

L0/L4 troubleshooting

Situation 1: L0 or L4 error is displayed immediately after the unit is switched on.

L0 - L4

TROUBLESHOOTING



Notes:

- 1 Measure the resistance between each of U, V and W terminal and each P and N terminal on the inverter module. All the resistances should be infinite. If any of them are not infinite, the inverter module is damaged and should be replaced.
- 2 When replacing an inverter module, a layer of thermally conductive silica gel should be painted on the IPM module, IGBT, diode, bridge rectifier (on the reverse side of the inverter module).

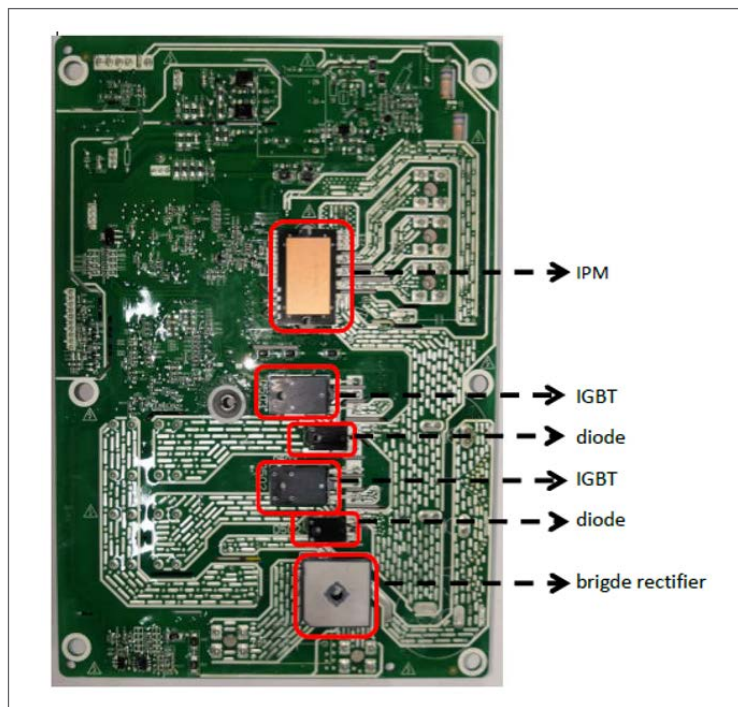

Situation 2: L0 or L4 error is displayed immediately after compressor startup

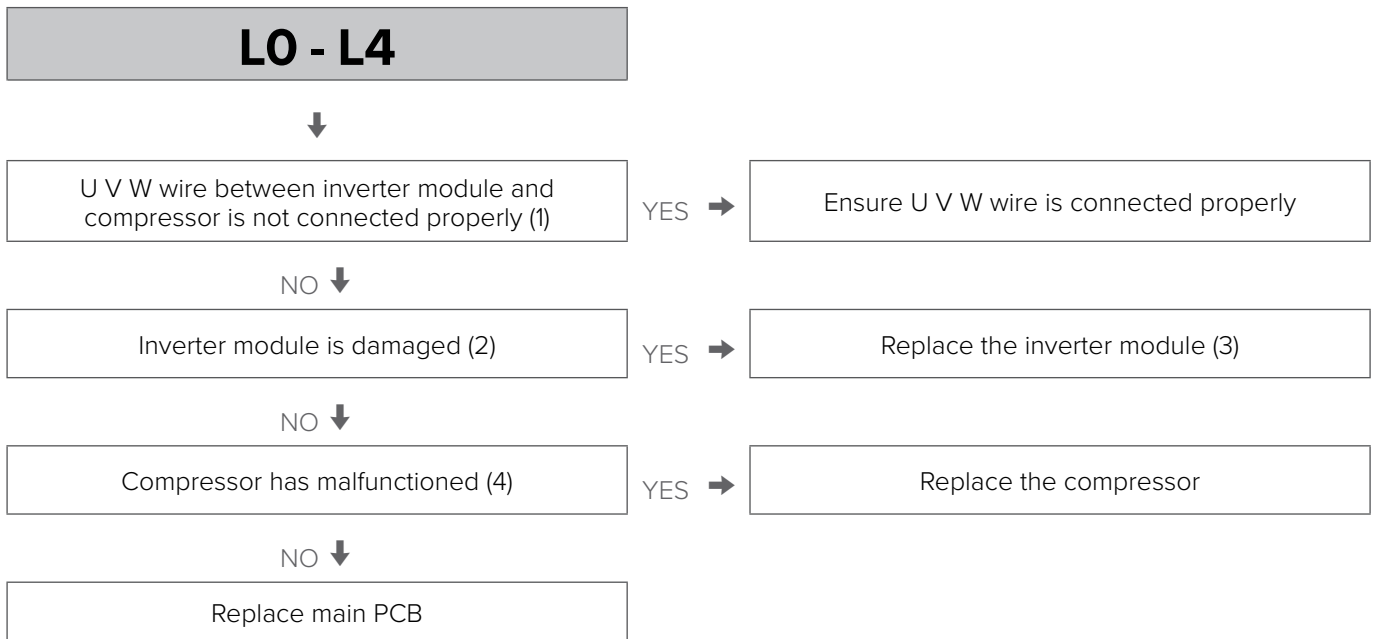

Notes:

- 1 Connect the U V W wire from the inverter module to the correct compressor terminals, as indicated by the labels on the compressor.
- 2 Measure the resistance between each of U, V and W terminal and each P and N terminal on the inverter module. All the resistances should be infinite. If any of them are not infinite, the inverter module is damaged and should be replaced.
- 3 When replacing an inverter module, a layer of thermally conductive silica gel should be painted on the IPM module, IGBT, diode, bridge rectifier (on the reverse side of the inverter module PCB).
- 4 The normal resistances of the inverter compressor are 0.7-1.5Ω among U V W and infinite between each of U V W and grounding. If any of the resistances differ from these specifications, the compressor has malfunctioned.

Situation 3: L0 error is displayed occasionally/irregularly

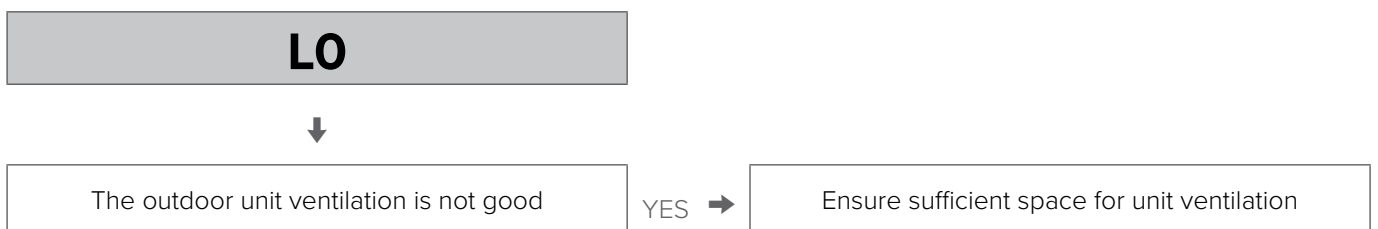

TROUBLESHOOTING

Situation 4: L0 or L4 error is displayed after the compressor has been in operation for a period of time and the compressor speed is over 60 rps

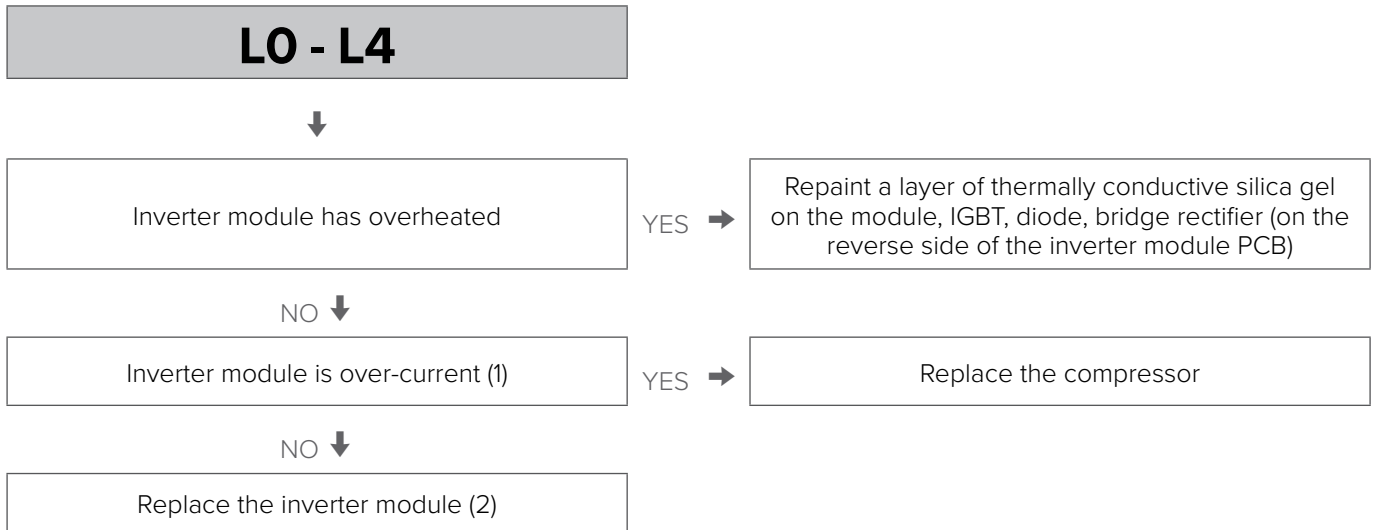

Notes:

- 1 Use clip-on ammeter to measure the compressor current. If the current is normal it indicates that the inverter module has failed, if it is abnormal, it indicates that the compressor has failed.
- 2 When replacing an inverter module, a layer of thermally conductive silica gel should be painted on the PFC and IPM modules (on the reverse side of the inverter module PCB).

L1/L2 Troubleshooting

The normal DC voltage between P and N terminals on the inverter module is 1.4 times the AC power supply in standby and 377 V when the fan motor is in operation. If the voltage is lower than 160V, the unit displays an L1 error. If the voltage is higher than 500V, the unit displays an L2 error.

Inverter module 2.1-3.14.1-5.1

Inverter module 6.1-7.1-8.1

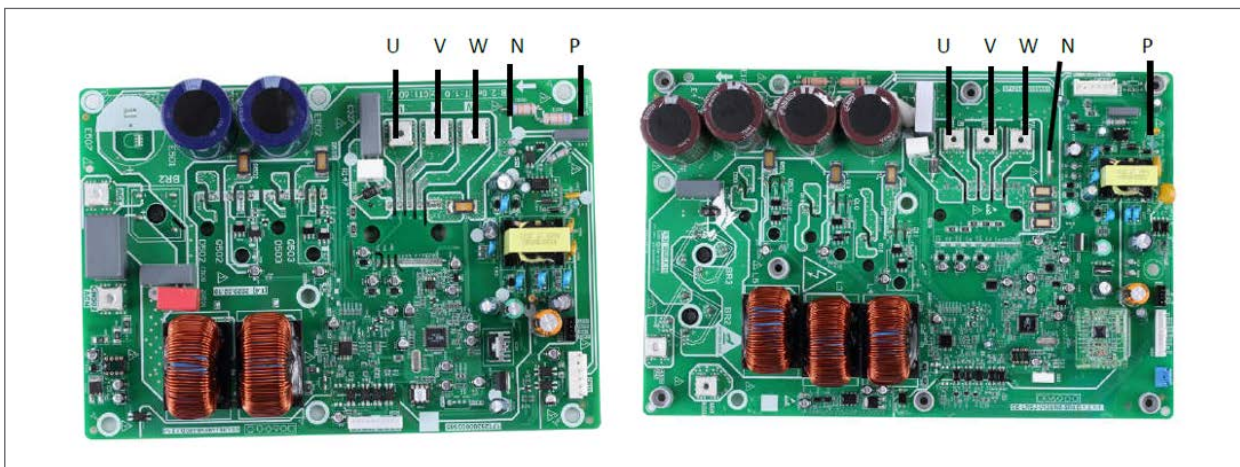

Situation 1: L1 or L2 error is displayed immediately after the unit is switched on

L1 - L2

TROUBLESHOOTING

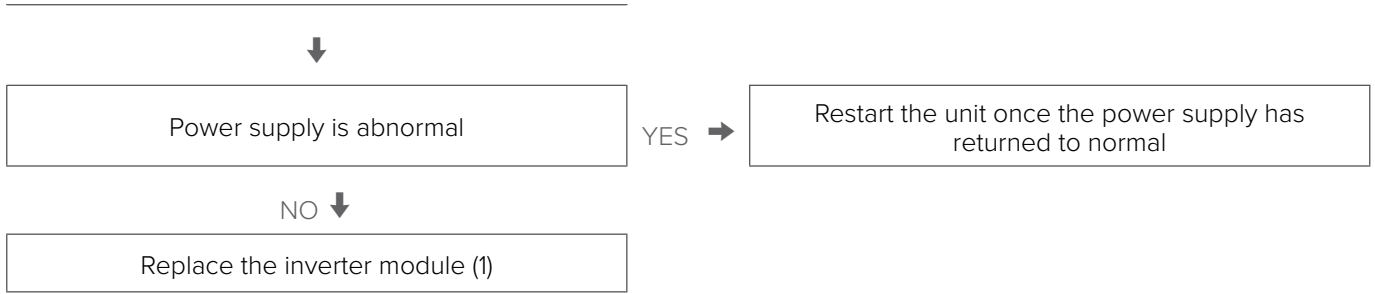

Notes:

- 1 When replacing an inverter module, a layer of thermally conductive silica gel should be painted on the IPM module, IGBT, diode, bridge rectifier (on the reverse side of the inverter module PCB).

Situation 2: L1 or L2 error is displayed after the compressor has been in operation for a period of time and the compressor speed is over 20 rps

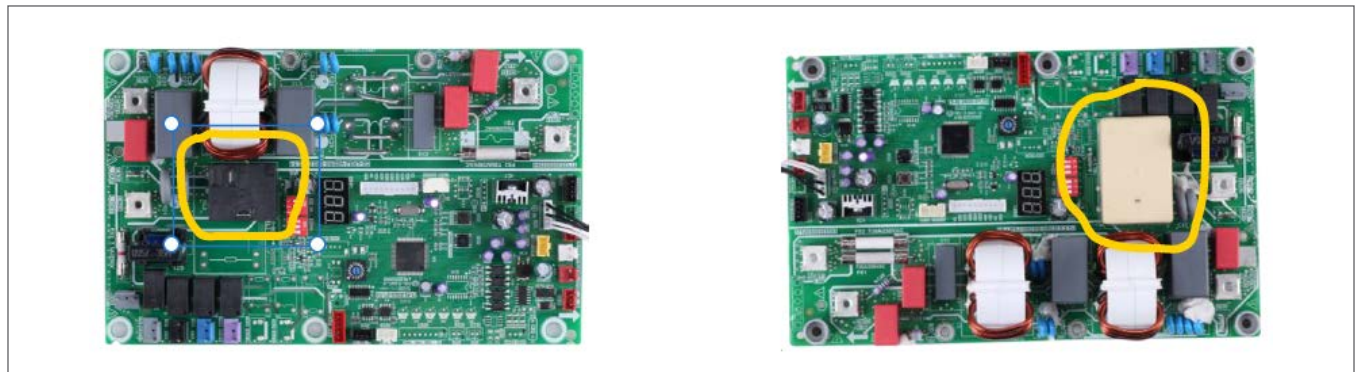
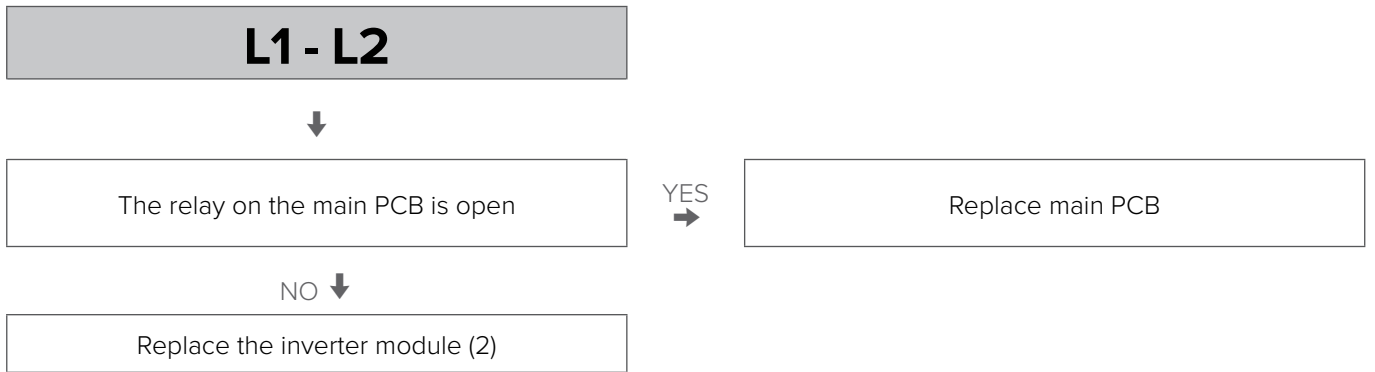

Notes:

- 1 If the fan motor is in operation and the DC voltage between P and N terminals on inverter module has decreased, the relay on the main control board of outdoor unit is open.
- 2 When replacing an inverter module, a layer of thermally conductive silica gel should be painted on the PFC and IPM modules (on the reverse side of the inverter module PCB).

L5/L8/L9 Troubleshooting

L5 - L8 - L9

TROUBLESHOOTING



The wire is not connected properly

YES →

Ensure the wire is connected properly

NO ↓

Inverter module PCB is damaged

YES →

Replace the inverter module (1)

NO ↓

Replace the compressor

Notes:

- 1 When replacing an inverter module, a layer of thermally conductive silica gel should be painted on the IPM module (on the reverse side of the inverter module PCB).

L0, L1, L2, L4, L5, L8, L9 - THREE-PHASE units

Description

- Inverter module protection
- The unit shuts down.
- Specific error code L0, L1, L2, L4, L5, L7, L8 or L9 is displayed on the main PCB

Possible causes

- Inverter module protection
- DC bus low or high voltage protection.
- MCE error (Bus low or high voltage protection or overcurrent protection **)
- Zero speed protection.
- Phase sequence error.
- Excessive compressor frequency variation.
- High pressure protector
- Contactor blocked or auto-diagnostic error 908

Specific error codes for inverter module protection

Error code	Description
L0	inverter module protection
L1	DC bus low voltage protection
L2	DC bus high voltage protection
L4	MCE error (**)
L5	zero speed protection
L8	compressor frequency variation greater than 15 Hz within one second protection
L9	current compressor frequency differs from set frequency by more than 15 Hz protection

The specific error codes can also be obtained from the LED indicators on the inverter module.

LED1/LED2 flashing pattern	Corresponding error
Flashes 8 times and stops for 1 second, then resumes.	L0 - inverter module protection
Flashes 9 times and stops for 1 second, then resumes	L1 - DC bus under-voltage protection
Flashes 10 times and stops for 1 second, then resumes.	L2 - DC bus overvoltage protection
Flashes 12 times and stops for 1 second, then resumes.	L4 - MCE error
Flashes 13 times and stops for 1 second, then resumes.	L5 - zero speed protection L5
Flashes 17 times and stops for 1 second, then resumes	L8 - compressor frequency variation greater than 15 Hz within one second protection
L9 - current compressor frequency differs from set frequency by more than 15 Hz protection	L8 - compressor frequency variation greater than 15 Hz within one second protection
Flashes 3 times and stops for 1 second, then resumes.	bH - Contactor blocked or auto-diagnostic error 908.
Flashes 3 times and stops for 1 second, then resumes.	P1 - high pressure protector

TROUBLESHOOTING

LED position

Sizes 6.1-8.1

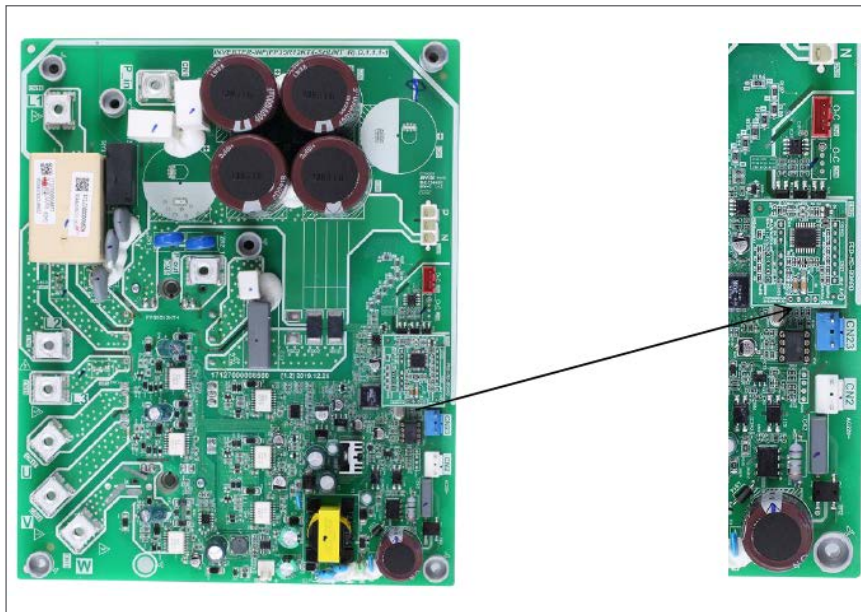

Sizes 9.1-14.1

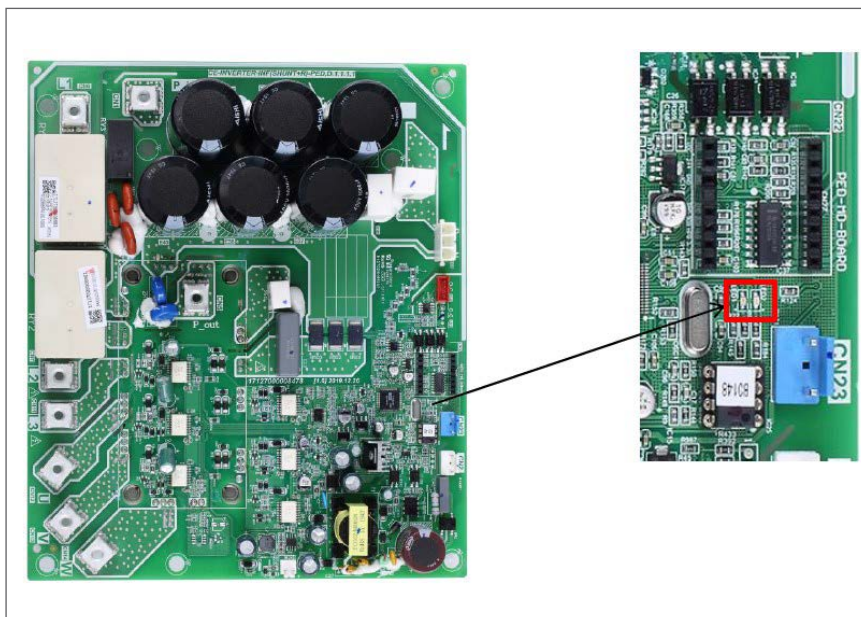

Principle of DC inverter

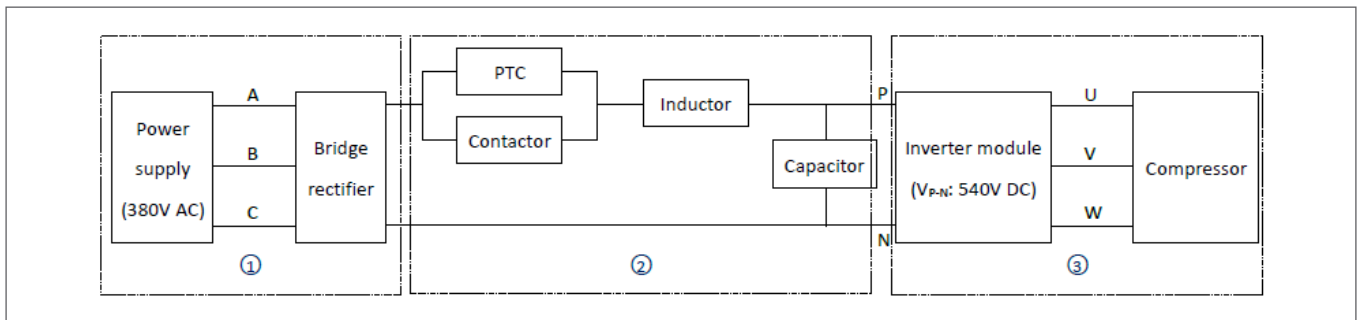

- 1 380-240V AC power supply changes to DC power supply after bridge rectifier
- 2 The contactor is open, current across the PTC to charge the capacitor, after 5 seconds the contactor closes.
- 3 The capacitor's steady output 540V DC power supply for inverter module P N terminals

LO Troubleshooting

Situation 1: LO error is displayed immediately after the unit is switched on

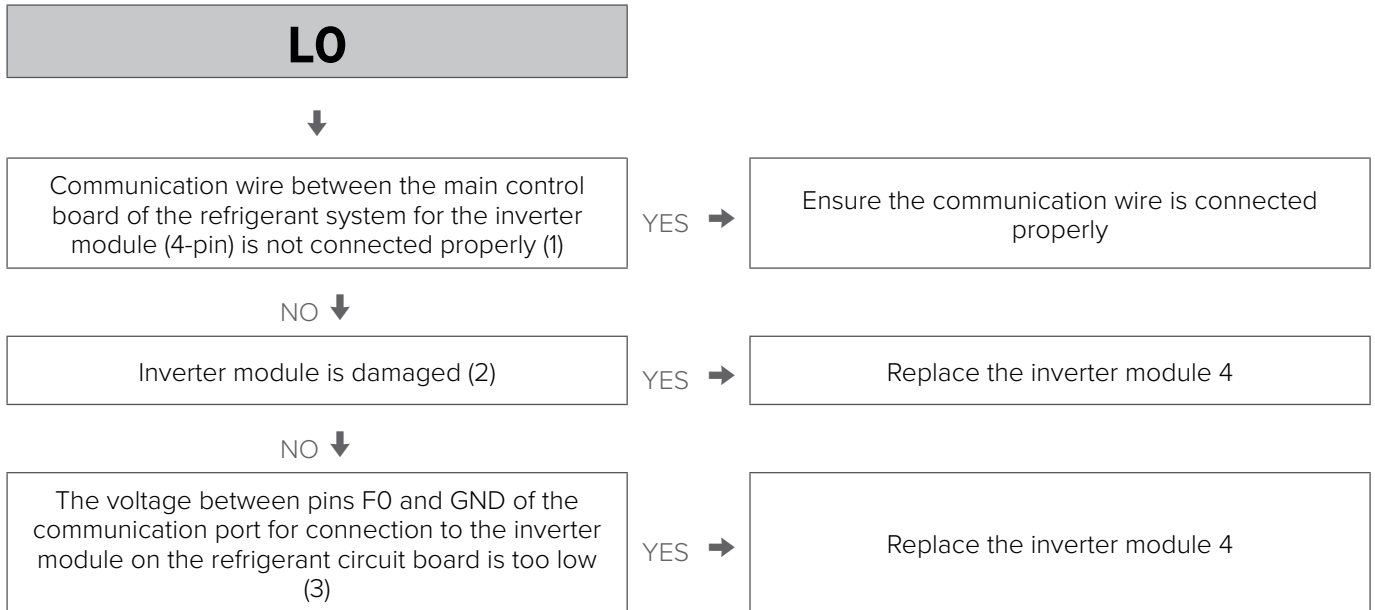

Notes:

- 1 The communication port between the main control board of the refrigerant system and the inverter module of the refrigerant system is: port CN36 on the main control board of the refrigerant system and port CN8 on the inverter module of the refrigerant system.
- 2 Measure the resistance between each of U, V and W terminal and each P and N terminal on the inverter module. All the resistances should be infinite. If any of them are not infinite, the inverter module is damaged and should be replaced.
- 3 The normal voltage between F0 and GND is 5V.
- 4 When replacing an inverter module, a layer of thermally conductive silica gel should be painted on the IPM module, IGBT, diode, bridge rectifier (on the reverse side of the inverter module PCB).

Voltage F0 and GND on IC28-1F0, IC28-4 GND

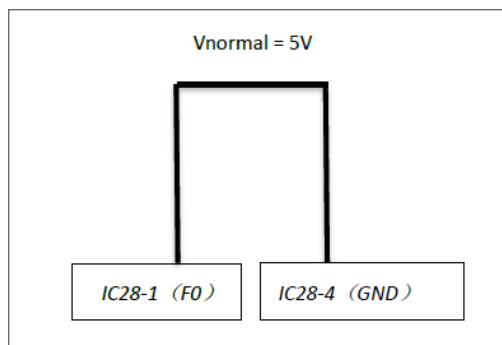

TROUBLESHOOTING

Situation 2: L0 error is displayed immediately after compressor startup

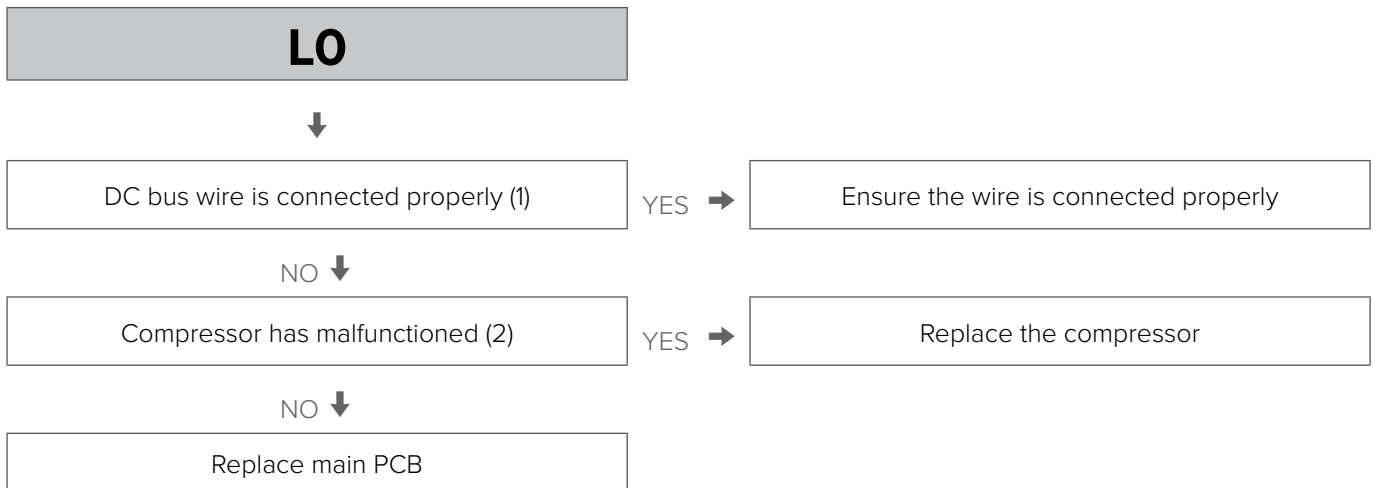

Notes:

- 1 The DC bus wire must run from N terminal on the inverter module, through the current sensor (indicated by the arrow on the current sensor) and end at N terminal on the capacitor.
- 2 The normal resistances of the inverter compressor are 0.7-1.5Ω among U V W and infinite between each of U V W and grounding. If any of the resistances differ from these specifications, the compressor has malfunctioned.

Sizes 6.1-8.1

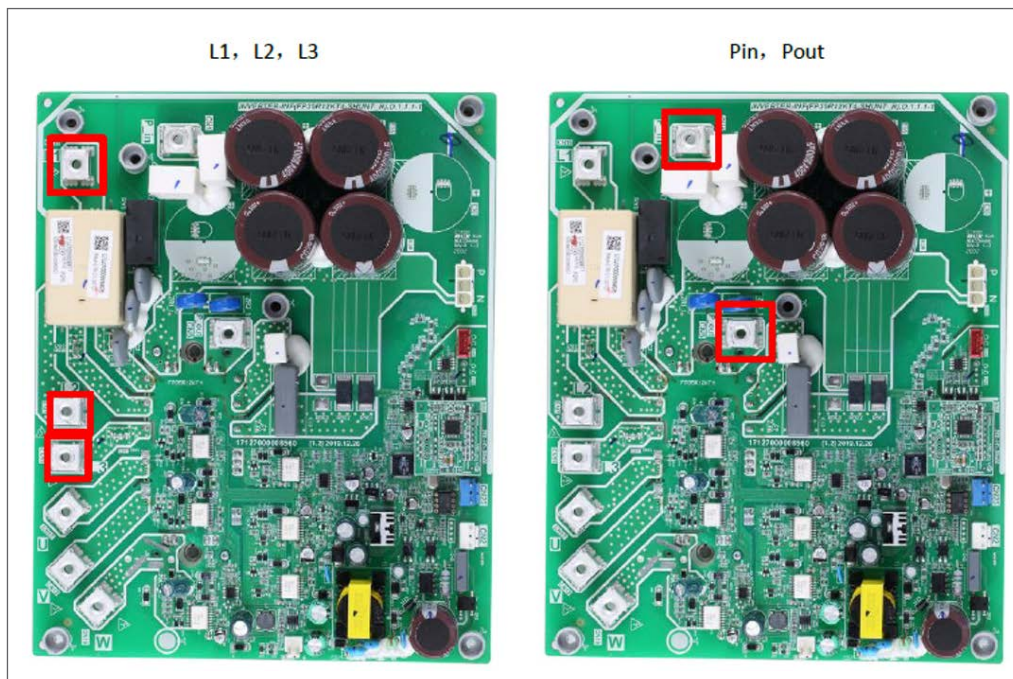

TROUBLESHOOTING

Sizes 9.1-14.1

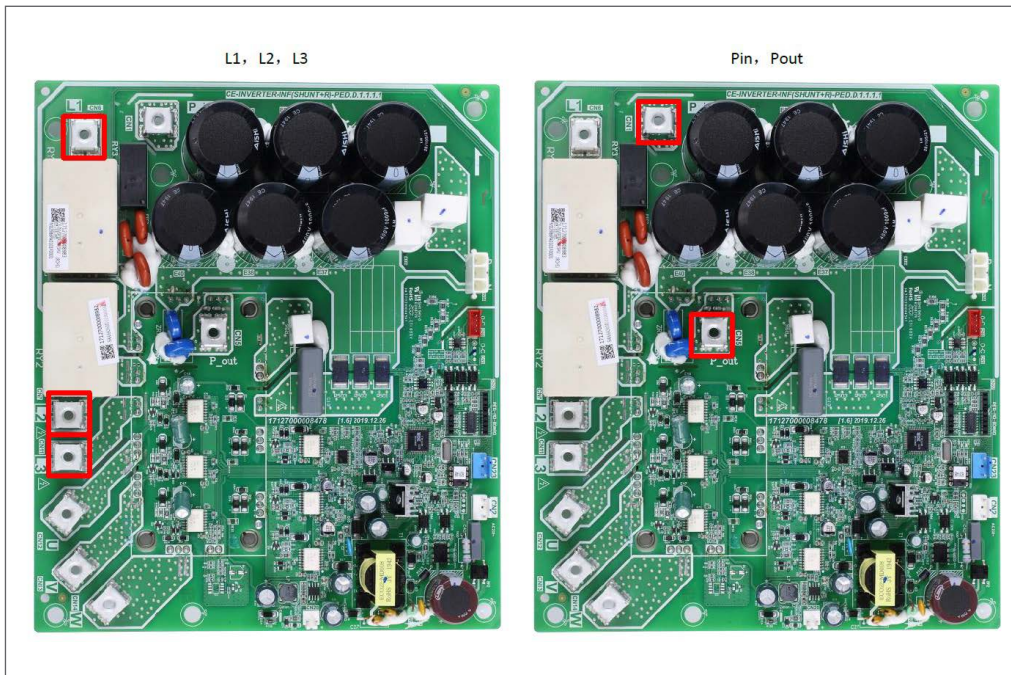

TROUBLESHOOTING

Situation 3: L0 error is displayed within 2 seconds of compressor startup

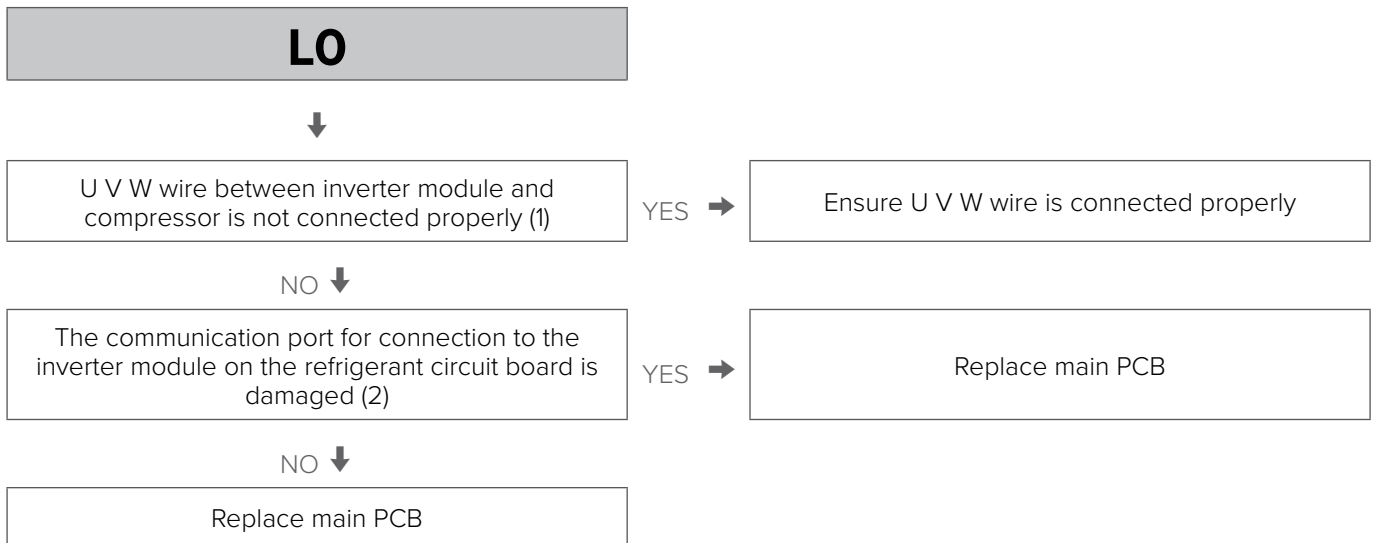

Notes:

1. Connect the U V W wire from the inverter module to the correct compressor terminals, as indicated by the labels on the compressor
2. Measure the voltage between W-, W+, V-, V+, U-, U+ and GND when the unit is in standby. The normal voltage should be 2.5 V-4 V and the six voltages should be the same, otherwise the communication terminal is faulty.

Inverter module connection port

Sizes 6.1-8.1

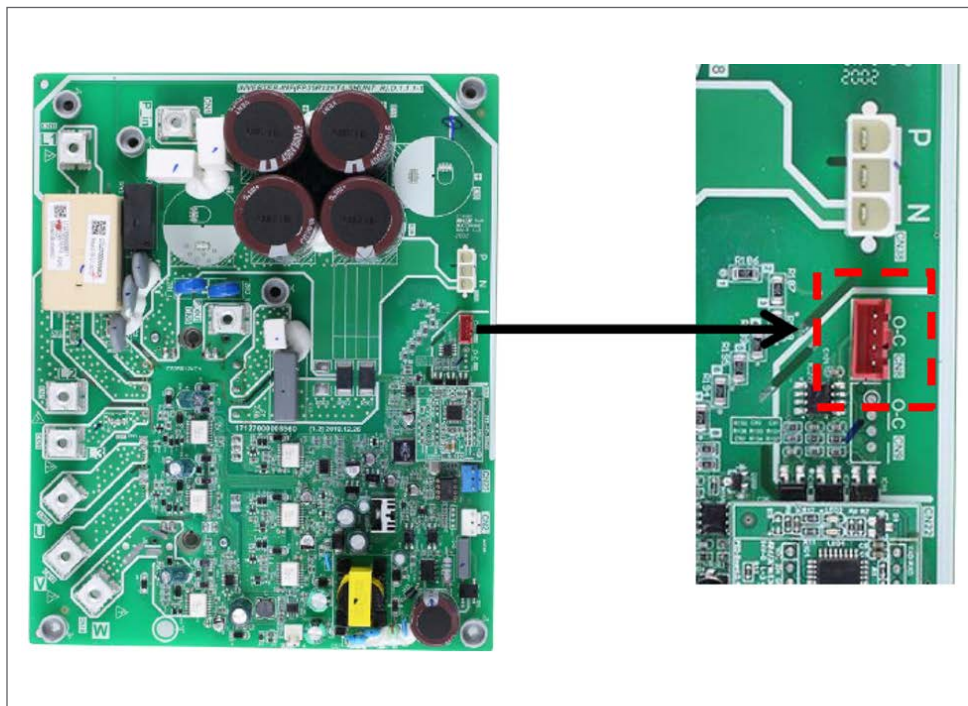

TROUBLESHOOTING

Sizes 9.1-14.1

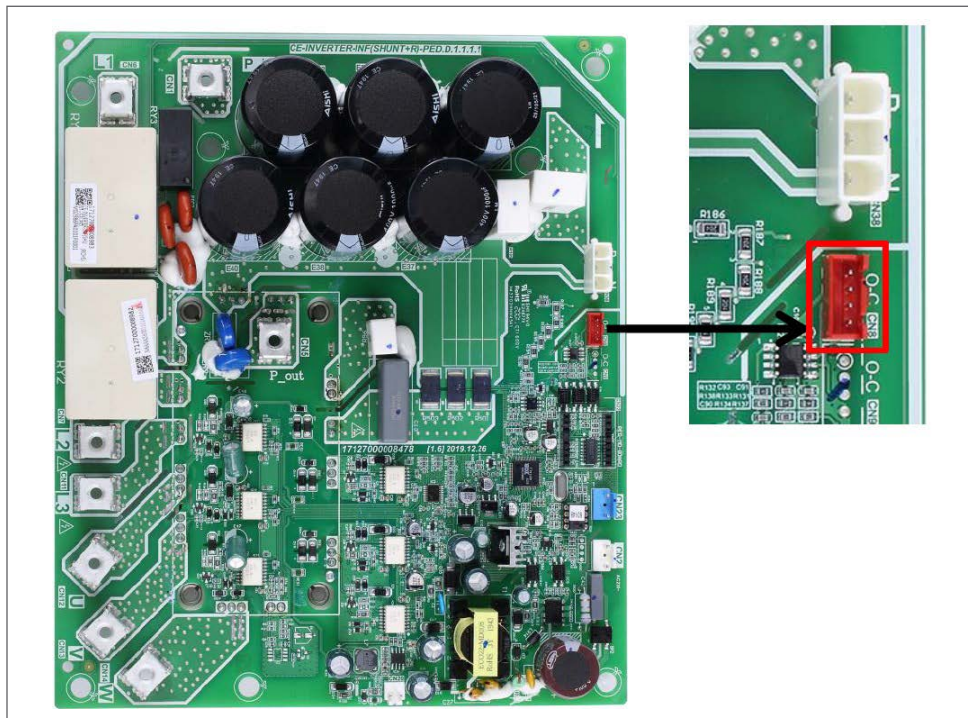

When replacing an inverter module, a layer of thermally conductive silica gel should be painted on the IPM module (on the reverse side of the inverter module PCB).

Situation 4: LO error is displayed after the compressor has been in operation for a period of time and the compressor speed is over 60 rps

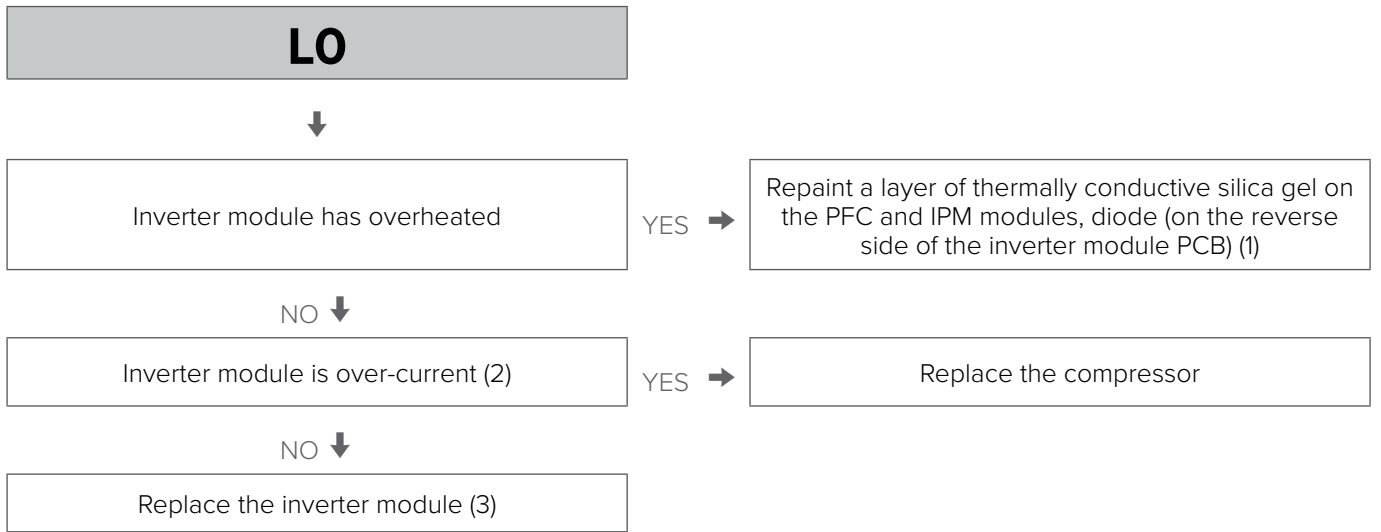

Notes:

1. When replacing an inverter module, a layer of thermally conductive silica gel should be painted on the IPM module (on the reverse side of the inverter module PCB).
2. Use clip-on ammeter to measure the compressor current, If the current is normal it indicates that the inverter module has failed, if it is abnormal, it indicates that the compressor is faulty.

TROUBLESHOOTING

Situation 5: L0 error is displayed occasionally/irregularly

L0



The outdoor unit ventilation is not good

YES →

Ensure sufficient space for unit ventilation

L1/L2 Troubleshooting

The normal DC voltage between P and N terminals on the inverter module is 540V. If the voltage is lower than 300V, the unit displays an L1 error. If the voltage is higher than 830V, the unit displays an L2 error.

P N voltage terminals

Sizes 6.1-8.1

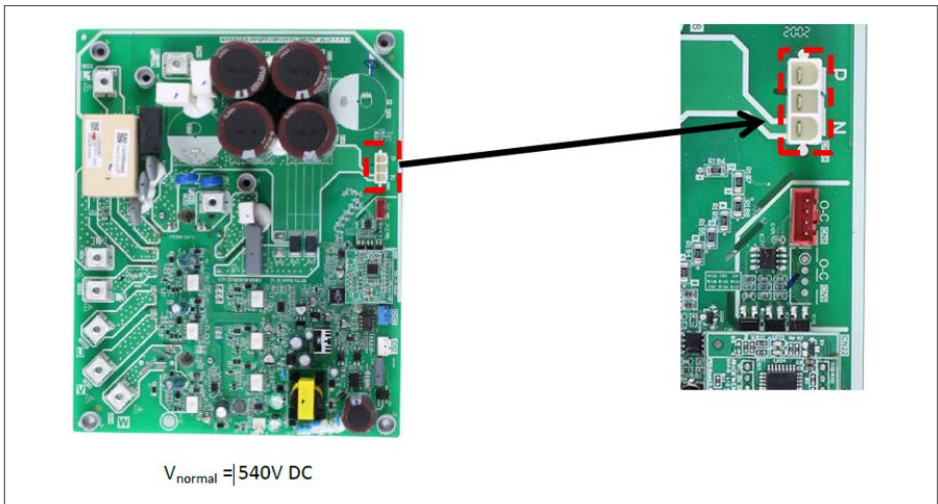

Sizes 9.1-14.1

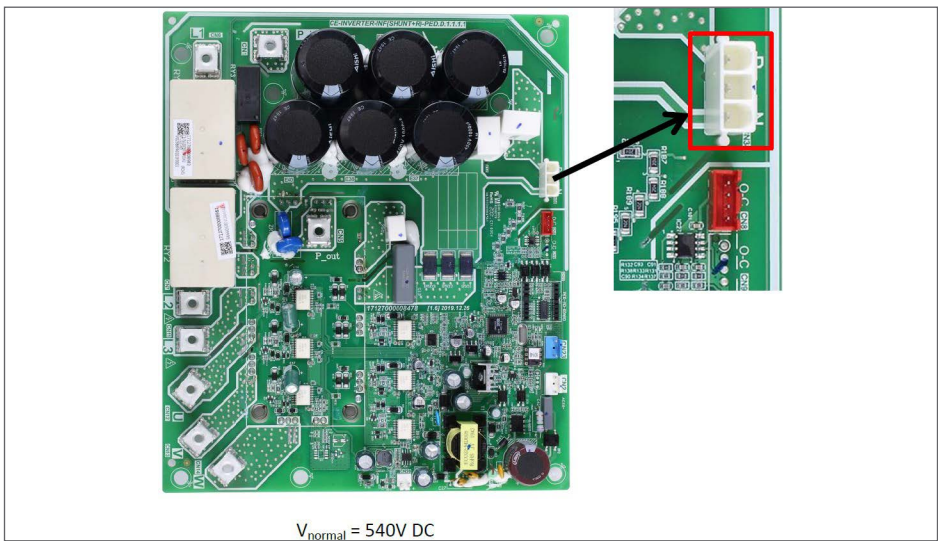

Situation 1: L1 or L2 error is displayed immediately after the outdoor unit is switched on

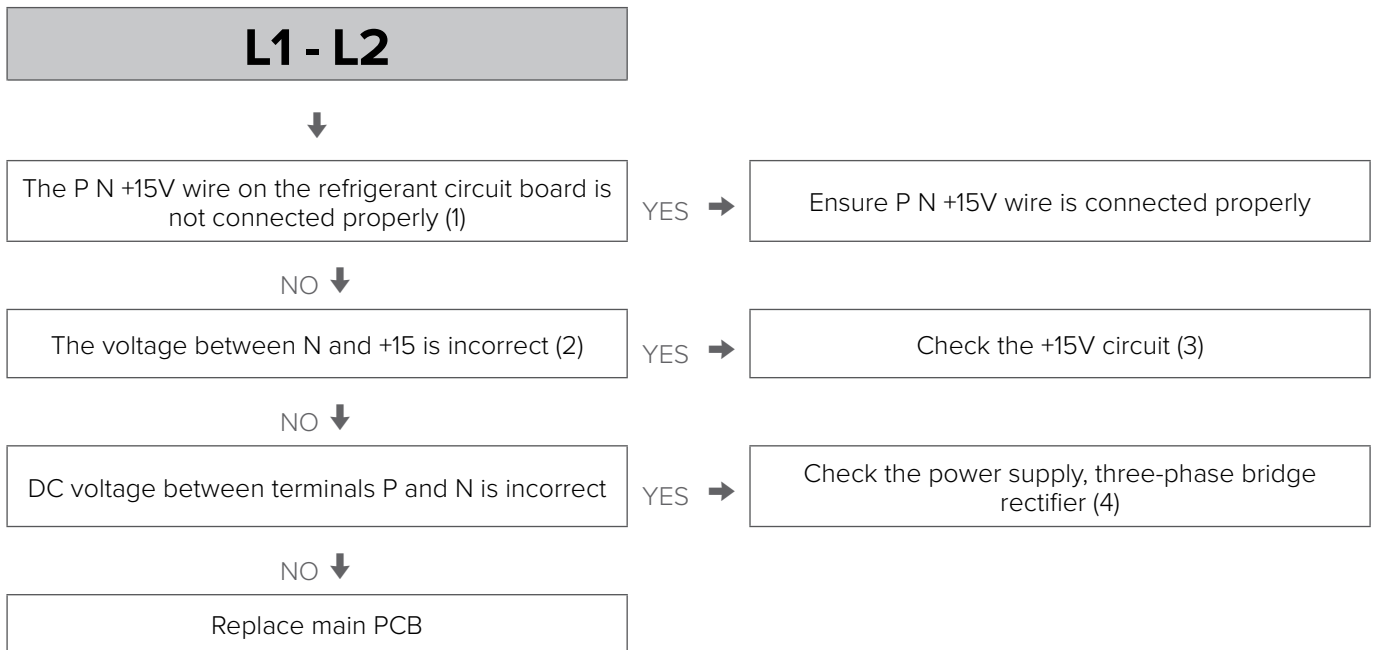

Notes:

- 1 P N +15V terminal on the refrigerant circuit board.
- 2 Voltage between N and +15.
- 3 Check the +15V circuit according to the corresponding wiring diagram. If the output power supply of the inverter module in IC4/5/6PIN12 is not +15V, the inverter module is faulty. If the output power supply of the inverter module is +15V, the main PCB is faulty.
- 4 Check the bridge rectifier using one of the two following methods
 - Method 1: measure the resistance between two of the 5 bridge rectifier terminals. If one of the resistances is close to zero, the bridge rectifier is faulty.
 - Method 2: use a multimeter to set the diode:
 - put the red probe on the negative DC power output terminal (terminal 5) and put the black probe on each of the AC power input terminals (terminals 1, 2 and 3) in turn. The voltage between terminal 5 and each of terminals 1, 2 and 3 should be approximately 0.378 V. If the voltage is 0, the bridge rectifier has failed.
 - put the red probe on the positive DC power output terminal (terminal 4) and put the black probe on each of the AC power input terminals (terminals 1, 2 and 3) in turn. The voltage between terminal 4 and each of terminals 1, 2 and 3 should be infinite. If the voltage is 0, the bridge rectifier is faulty.

TROUBLESHOOTING

Sizes 6.1-8.1

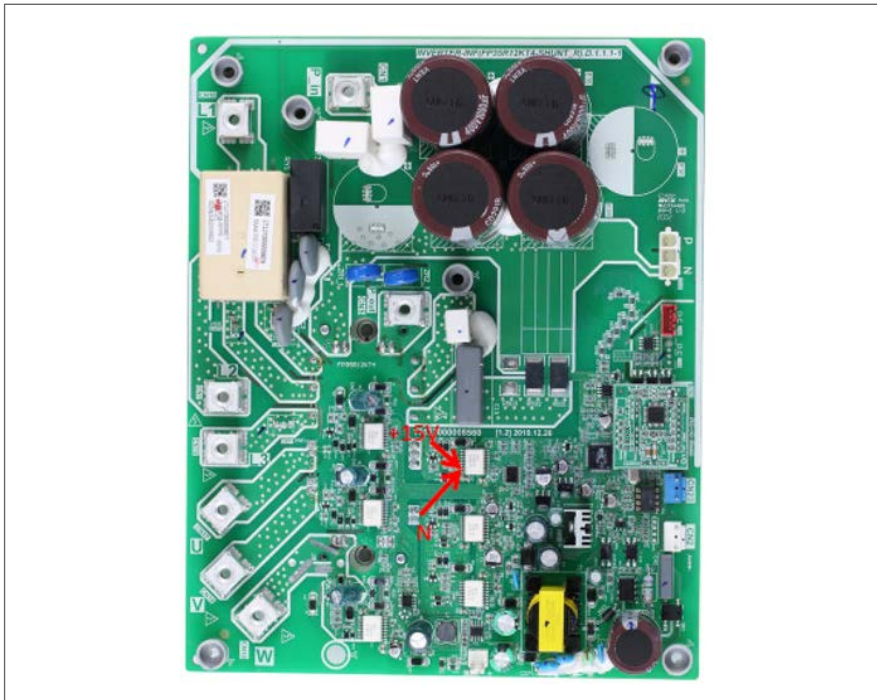

Sizes 9.1-14.1

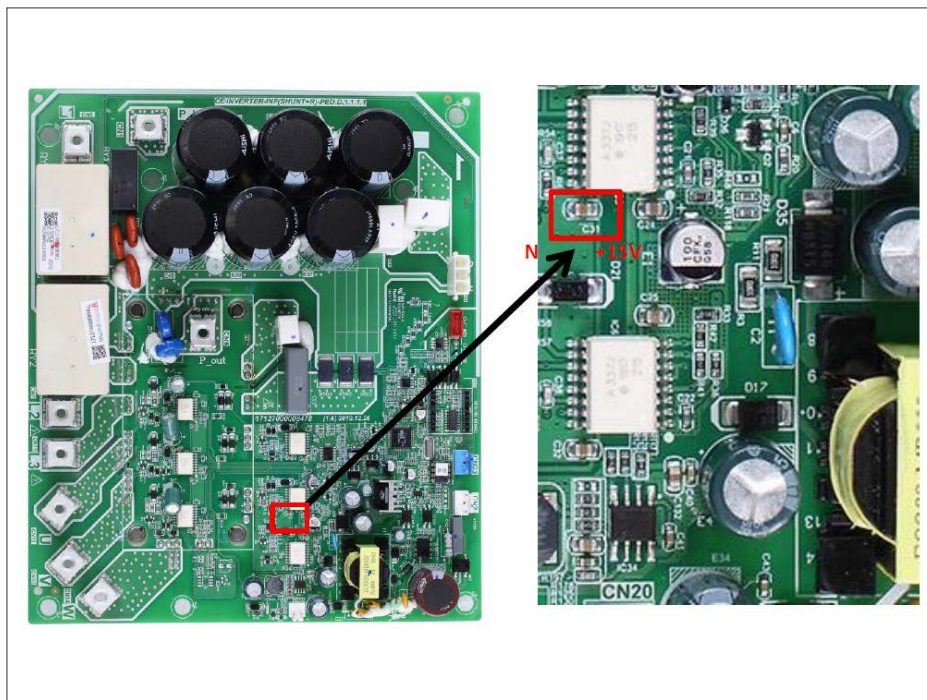

TROUBLESHOOTING

Bridge rectifier

Sizes 6.1-8.1

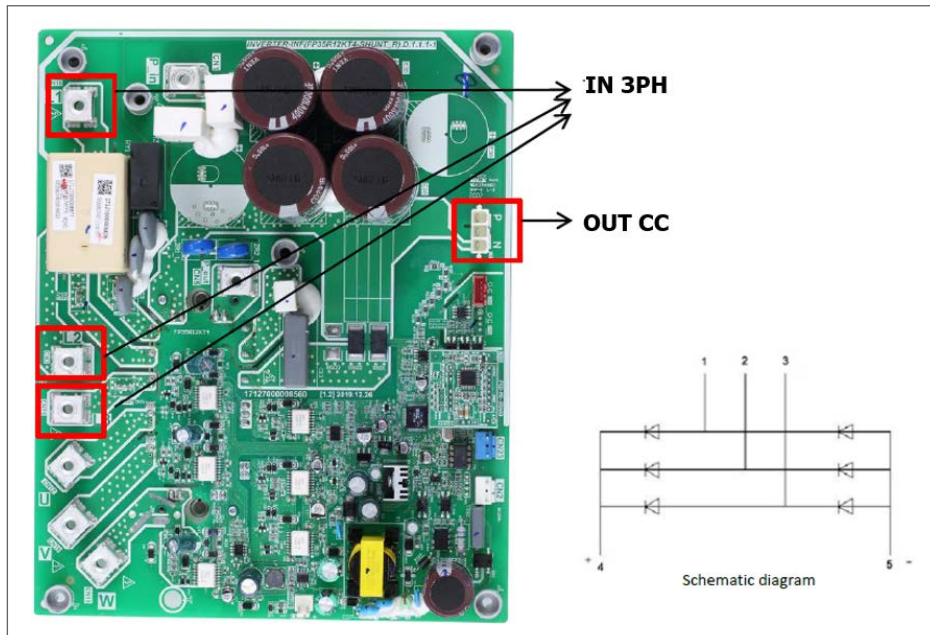

Sizes 9.1-14.1

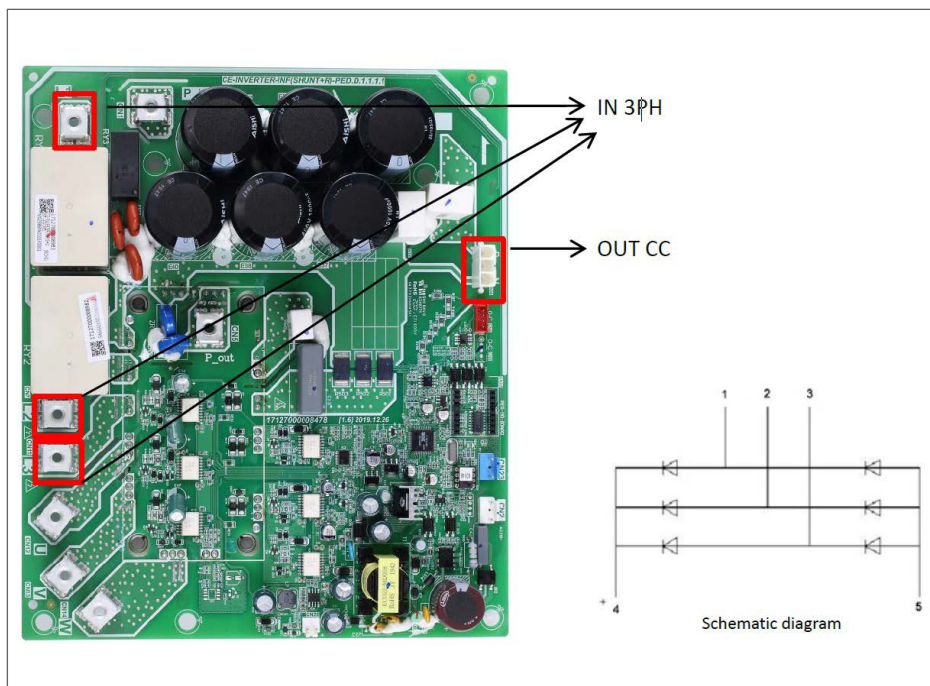

L4 Troubleshooting

Situation 1: L4 error is displayed immediately after the unit is switched on

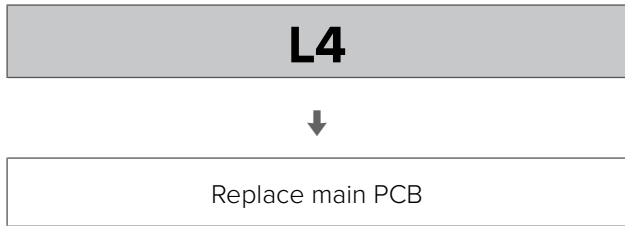

Situation 2: L4 error is displayed after the compressor has been in operation for a period of time and the compressor speed is over 60 rps

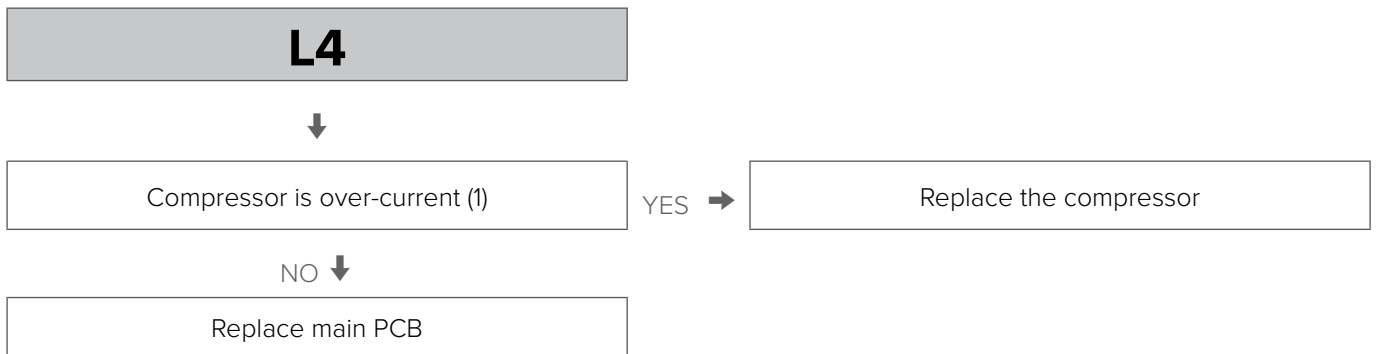

Notes:

- 1 Restart the unit, use clamp ammeter to measure the compressor current, if the current is normal it indicates that the compressor is faulty, if the current is abnormal it indicates that the inverter PCB is faulty.

L5/L8/L9 Troubleshooting

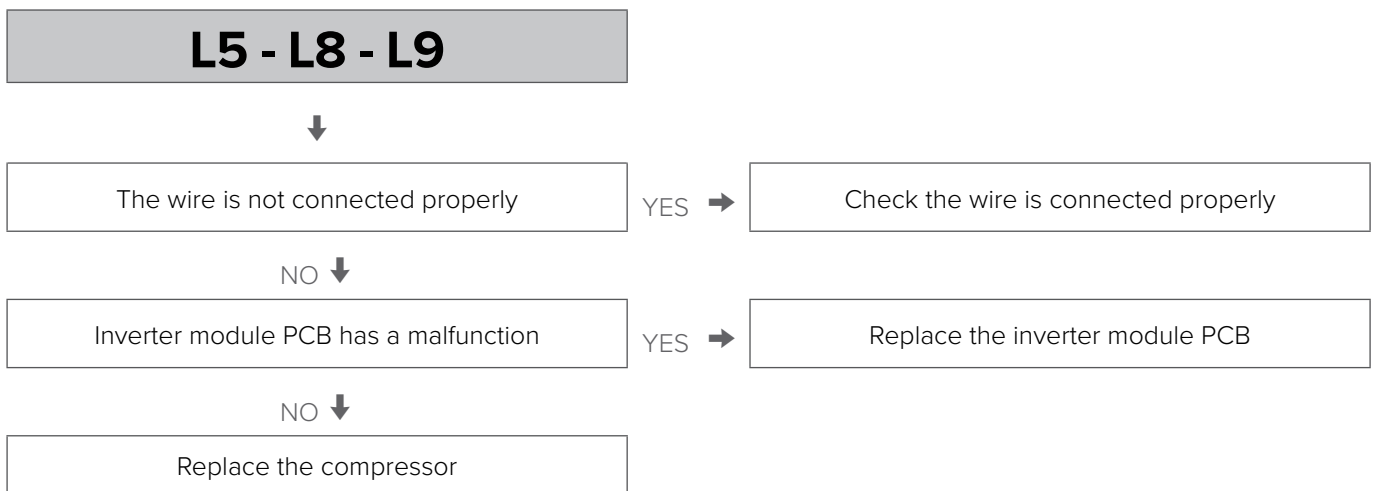

BH

Description

- PED PCB faulty
- The unit shuts down.
- The error code is displayed on the main PCB and user interface.

Possible causes

- Power supply problem.
- PED board faulty.
- IPM module faulty

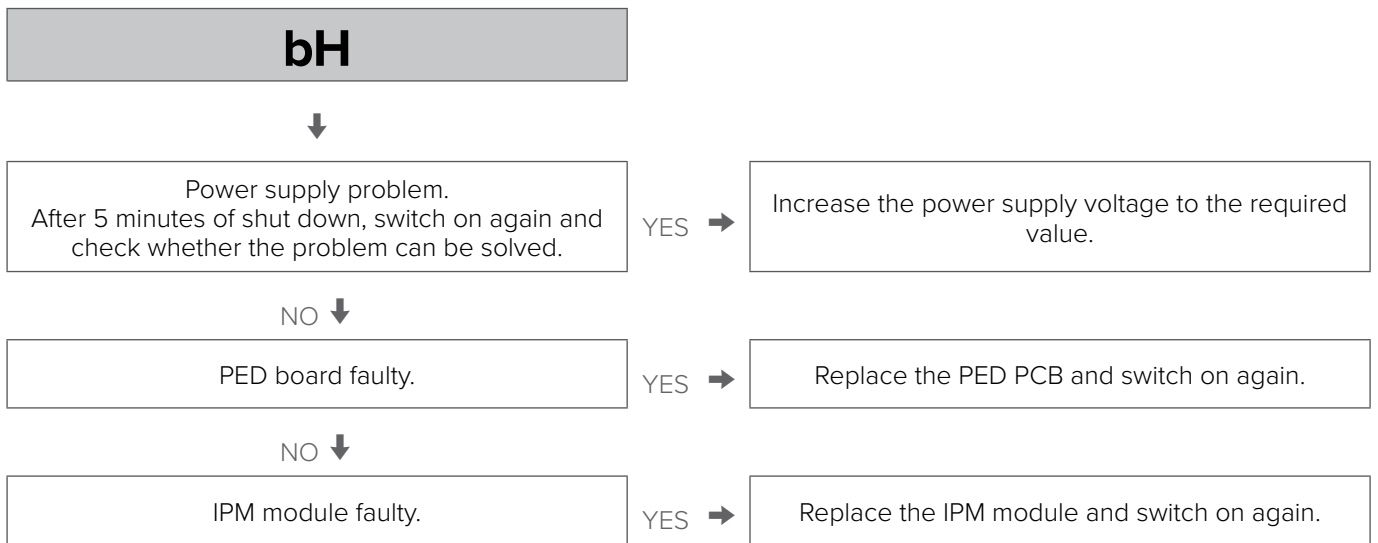

PB

Description

- Water side heat exchanger antifreeze protection.
- The unit shuts down.
- The error code is displayed on the main PCB and the relative ANTI.FREEZE icon is displayed on the user interface.

Possible causes

- Normal system protection.
- Temperature sensor not connected properly or has malfunctioned.
- Main PCB is damaged.

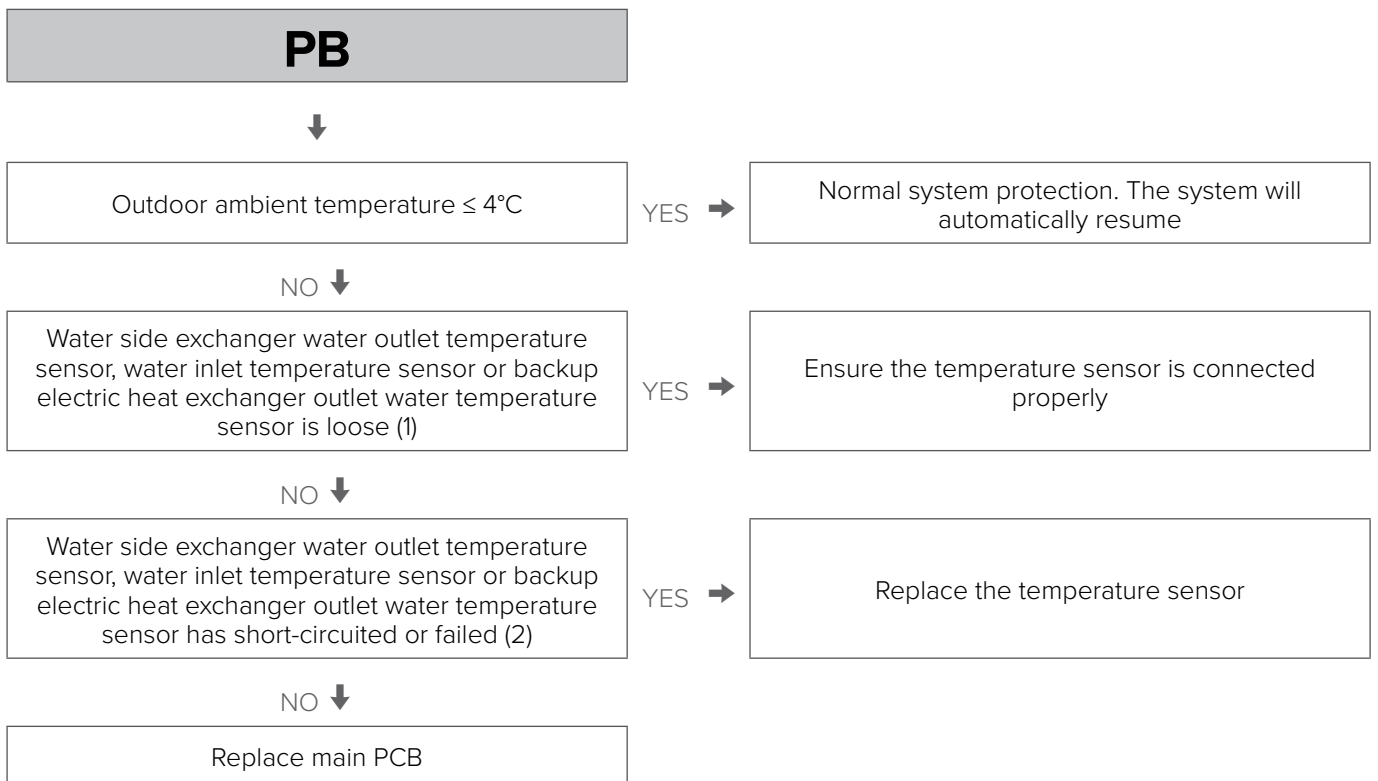

- 1 Backup electric exchanger water outlet temperature sensor, water side exchanger water outlet temperature sensor and water side exchanger water outlet temperature sensor connections are port CN6 on the main PCB.
- 2 Measure sensor resistance. If the resistance is too low, the sensor has short-circuited. If the resistance is not consistent with the sensor’s resistance characteristics table, the sensor has failed.

PD

Description

- High temperature protection of air side heat exchanger refrigerant outlet in cooling mode. When the air side heat exchanger refrigerant outlet temperature is higher than 61°C for more than 3 seconds, the system displays Pd protection and the unit shuts down. When the air side heat exchanger refrigerant outlet temperature returns below 55°C, Pd is removed and normal operation resumes.
- The unit shuts down.
- The error code is displayed on the main PCB and user interface.

Possible causes

- Temperature sensor not connected properly or has malfunctioned.
- Poor condenser heat exchange.
- Fan motor damaged.
- Main PCB is damaged.

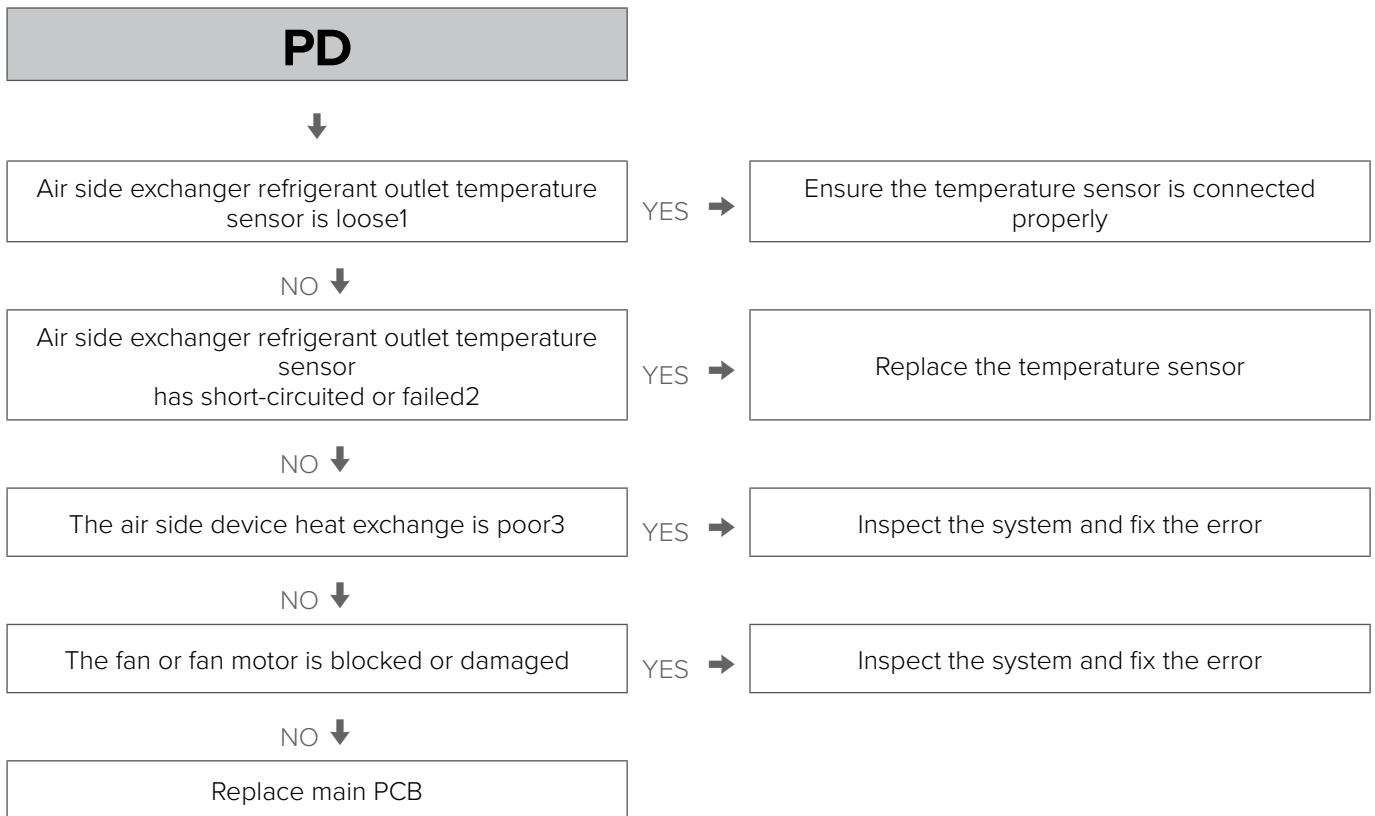

Notes:

- 1 Air side exchanger refrigerant outlet temperature sensor and outdoor ambient temperature sensor connection is port CN9 on the unit’s main PCB.
- 2 Measure sensor resistance. If the resistance is too low, the sensor has short-circuited. If the resistance is not consistent with the sensor’s resistance characteristics table, the sensor has failed.
- 3 Check air side heat exchanger, fan and air outlets for dirt/blockages.
- 4 The high pressure switch connection is port CN13 on single-phase units and port CN31 on three-phase units.

PP - Hb

Description

- Water side heat exchanger inlet temperature is higher than outlet temperature in heating mode.
- The unit shuts down.
- The error code is displayed on the main PCB and user interface.
- Hb indicates that PP has been displayed 3 times.

Possible causes

- Temperature sensor not connected properly or has malfunctioned.
- 4-way valve is blocked or damaged.
- Main PCB is damaged.

TROUBLESHOOTING

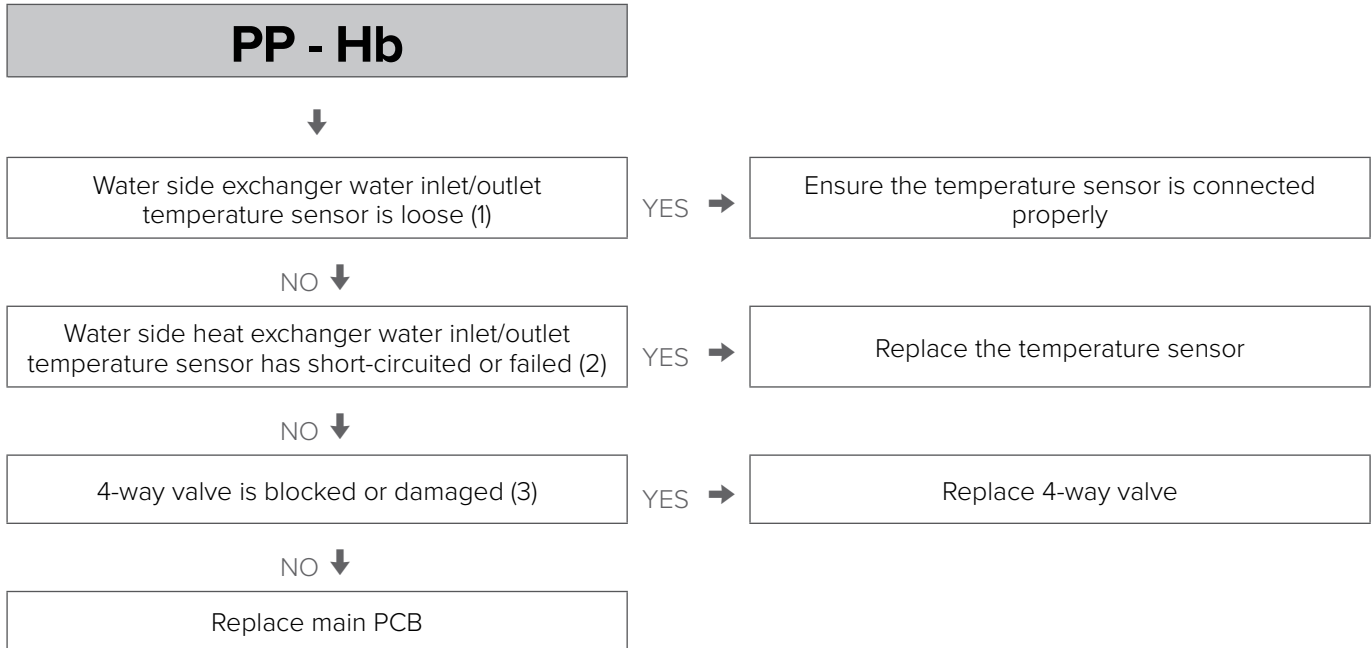

Notes:

- 1 |t|Water side electric exchanger water inlet temperature sensor and water side exchanger water outlet temperature sensor connection is port CN6 on the main PCB.
- 2 |t|Measure sensor resistance. If the resistance is too low, the sensor has short-circuited. If the resistance is not consistent with the sensor’s resistance characteristics table, the sensor has failed.
- 3 |t|Restart the unit in cooling mode to change the refrigerant flow direction. If the unit does not operate normally, the 4-way valve is blocked or damaged.

HE

Description

- Communication error between hydronic module main control board and Ta/ambient thermostat transfer PCB
- The unit shuts down
- The error code is displayed on the water circuit PCB, main PCB and user interface.

Possible causes

- Ta / Ambient thermostat not connected.
- Ta / Ambient thermostat damaged.

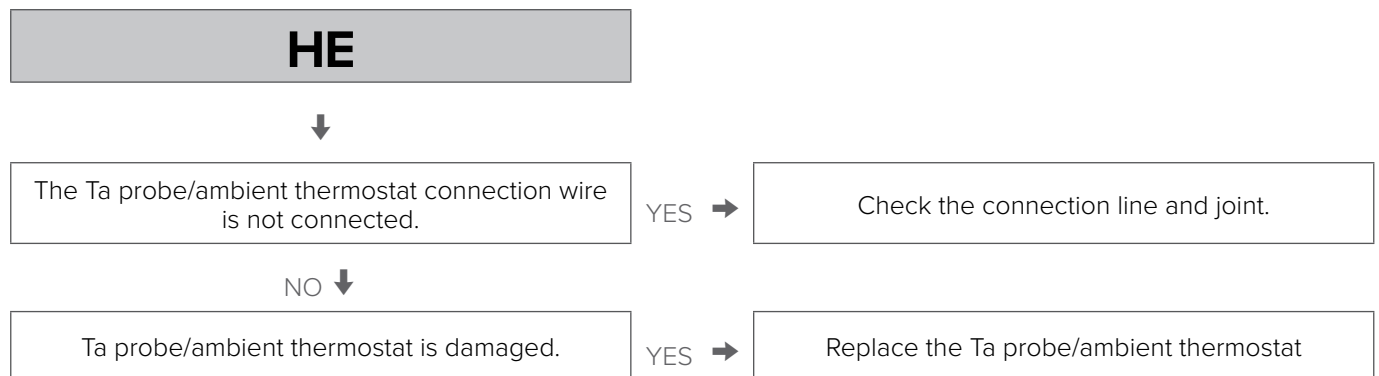

Hd

Description

- Communication error between master unit and slave unit(s) (in parallel)
- The unit shuts down.
- The error code is displayed on the water circuit PCB, main PCB and user interface.

Possible causes

- SW9 DIP switch with incorrect settings
- More than two units are connected to the wired controller
- The switch-on interval between the master unit and the slave unit is longer than 2 minutes
- Wire connection error
- Unstable communication between the units
- Address code missing or address code setting duplicated
- The main board fuse is damaged BH

TROUBLESHOOTING

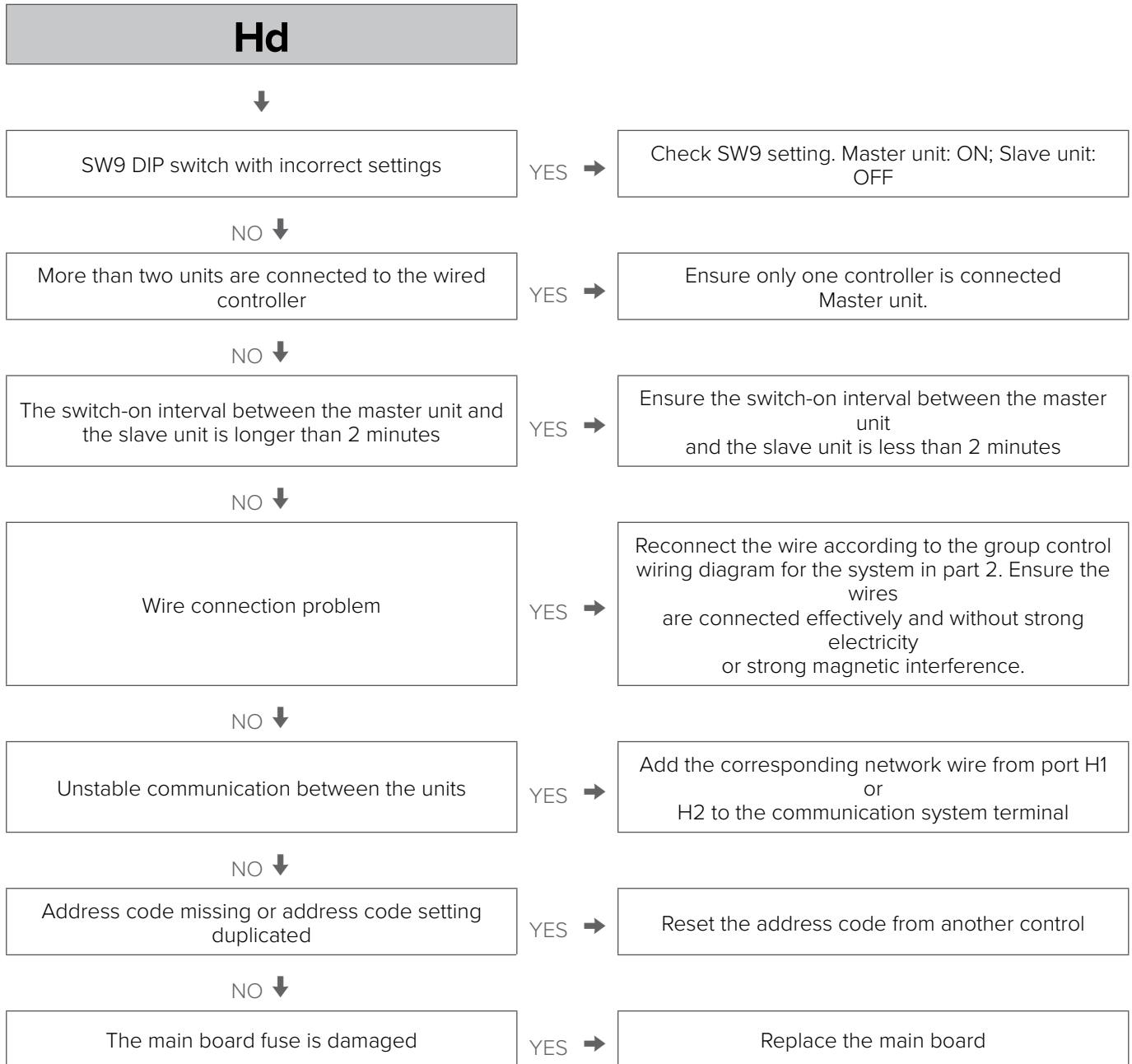

9. Temperature sensor resistance characteristics

Outdoor ambient temperature sensor, water side heat exchanger refrigerant inlet/outlet (liquid/gas pipe) temperature sensor, air side heat exchanger refrigerant outlet temperature sensor and suction pipe temperature sensor resistance characteristics

Temp. (°C)	Res. (kΩ)	Temp. (°C)	Res. (kΩ)	Temp. (°C)	Res. (kΩ)	Temp. (°C)	Res. (kΩ)
-25	144.266	15	16.079	55	2.841	95	0.708
-24	135.601	16	15.313	56	2.734	96	0.686
-23	127.507	17	14.588	57	2.632	97	0.666
-22	119.941	18	13.902	58	2.534	98	0.646
-21	112.867	19	13.251	59	2.44	99	0.627
-20	106.732	20	12.635	60	2.35	100	0.609
-19	100.552	21	12.05	61	2.264	101	0.591
-18	94.769	22	11.496	62	2.181	102	0.574
-17	89.353	23	10.971	63	2.102	103	0.558
-16	84.278	24	10.473	64	2.026	104	0.542
-15	79.521	25	10	65	1.953	105	0.527
-14	75.059	26	9.551	66	1.883		
-13	70.873	27	9.125	67	1.816		
-12	66.943	28	8.721	68	1.752		
-11	63.252	29	8.337	69	1.69		
-10	59.784	30	7.972	70	1.631		
-9	56.524	31	7.625	71	1.574		
-8	53.458	32	7.296	72	1.519		
-7	50.575	33	6.982	73	1.466		
-6	47.862	34	6.684	74	1.416		
-5	45.308	35	6.401	75	1.367		
-4	42.903	36	6.131	76	1.321		
-3	40.638	37	5.874	77	1.276		
-2	38.504	38	5.63	78	1.233		
-1	36.492	39	5.397	79	1.191		
0	34.596	40	5.175	80	1.151		
1	32.807	41	4.964	81	1.113		
2	31.12	42	4.763	82	1.076		
3	29.528	43	4.571	83	1.041		
4	28.026	44	4.387	84	1.007		
5	26.608	45	4.213	85	0.974		
6	25.268	46	4.046	86	0.942		

TEMPERATURE SENSOR RESISTANCE CHARACTERISTICS

Temp. (°C)	Res. (kΩ)	Temp. (°C)	Res. (kΩ)	Temp. (°C)	Res. (kΩ)	Temp. (°C)	Res. (kΩ)
7	24.003	47	3.887	87	0.912		
8	22.808	48	3.735	88	0.883		
9	21.678	49	3.59	89	0.855		
10	20.61	50	3.451	90	0.828		
11	19.601	51	3.318	91	0.802		
12	18.646	52	3.191	92	0.777		
13	17.743	53	3.069	93	0.753		
14	16.888	54	2.952	94	0.73		

TEMPERATURE SENSOR RESISTANCE CHARACTERISTICS

Compressor discharge pipe temperature sensor resistance characteristics

Temp. (°C)	Res. (kΩ)	Temp. (°C)	Res. (kΩ)	Temp. (°C)	Res. (kΩ)	Temp. (°C)	Res. (kΩ)
-20	542.7	20	68.66	60	13.59	100	3.702
-19	511.9	21	65.62	61	13.11	101	3.595
-18	483.0	22	62.73	62	12.65	102	3.492
-17	455.9	23	59.98	63	12.21	103	3.392
-16	430.5	24	57.37	64	11.79	104	3.296
-15	406.7	25	54.89	65	11.38	105	3.203
-14	384.3	26	52.53	66	10.99	106	3.113
-13	363.3	27	50.28	67	10.61	107	3.025
-12	343.6	28	48.14	68	10.25	108	2.941
-11	325.1	29	46.11	69	9.902	109	2.860
-10	307.7	30	44.17	70	9.569	110	2.781
-9	291.3	31	42.33	71	9.248	111	2.704
-8	275.9	32	40.57	72	8.940	112	2.630
-7	261.4	33	38.89	73	8.643	113	2.559
-6	247.8	34	37.30	74	8.358	114	2.489
-5	234.9	35	35.78	75	8.084	115	2.422
-4	222.8	36	34.32	76	7.820	116	2.357
-3	211.4	37	32.94	77	7.566	117	2.294
-2	200.7	38	31.62	78	7.321	118	2.233
-1	190.5	39	30.36	79	7.086	119	2.174
0	180.9	40	29.15	80	6.859	120	2.117
1	171.9	41	28.00	81	6.641	121	2.061
2	163.3	42	26.90	82	6.430	122	2.007
3	155.2	43	25.86	83	6.228	123	1.955
4	147.6	44	24.85	84	6.033	124	1.905
5	140.4	45	23.89	85	5.844	125	1.856
6	133.5	46	22.89	86	5.663	126	1.808
7	127.1	47	22.10	87	5.488	127	1.762
8	121.0	48	21.26	88	5.320	128	1.717
9	115.2	49	20.46	89	5.157	129	1.674
10	109.8	50	19.69	90	5.000	130	1.632
11	104.6	51	18.96	91	4.849		
12	99.69	52	18.26	92	4.703		

TEMPERATURE SENSOR RESISTANCE CHARACTERISTICS

Temp. (°C)	Res. (kΩ)	Temp. (°C)	Res. (kΩ)	Temp. (°C)	Res. (kΩ)	Temp. (°C)	Res. (kΩ)
13	95.05	53	17.58	93	4.562		
14	90.66	54	16.94	94	4.426		
15	86.49	55	16.32	95	4.294		
16	82.54	56	15.73	96	4.167		
17	78.79	57	15.16	97	4.045		
18	75.24	58	14.62	98	3.927		
19	71.86	59	14.09	99	3.812		

TEMPERATURE SENSOR RESISTANCE CHARACTERISTICS

Water side exchanger water inlet/outlet temperature sensor, backup exchanger water outlet temperature sensor and DHW temperature sensor resistance characteristics

Temp. (°C)	Res. (kΩ)	Temp. (°C)	Res. (kΩ)	Temp. (°C)	Res. (kΩ)	Temp. (°C)	Res. (kΩ)
-30	867.29	10	98.227	50	17.600	100	3.702
-29	815.80	11	93.634	51	16.943	101	3.595
-28	767.68	12	89.278	52	16.315	102	3.492
-27	722.68	13	85.146	53	15.713	103	3.392
-26	680.54	14	81.225	54	15.136	104	3.296
-25	641.07	15	77.504	55	14.583	105	3.203
-24	604.08	16	73.972	56	14.054	106	3.113
-23	569.39	17	70.619	57	13.546	107	3.025
-22	536.85	18	67.434	58	13.059	108	2.941
-21	506.33	19	64.409	59	12.592	109	2.860
-20	477.69	20	61.535	60	12.144	110	2.781
-19	450.81	21	58.804	61	11.715	111	2.704
-18	425.59	22	56.209	62	11.302	112	2.630
-17	401.91	23	53.742	63	10.906	113	2.559
-16	379.69	24	51.396	64	10.526	114	2.489
-15	358.83	25	49.165	65	10.161	115	2.422
-14	339.24	26	47.043	66	9.8105	116	2.357
-13	320.85	27	45.025	67	9.4736	117	2.294
-12	303.56	28	43.104	68	9.1498	118	2.233
-11	287.33	29	41.276	69	8.8387	119	2.174
-10	272.06	30	39.535	70	8.5396	120	2.117
-9	257.71	31	37.878	71	8.2520	121	2.061
-8	244.21	32	36.299	72	7.9755	122	2.007
-7	231.51	33	34.796	73	7.7094	123	1.955
-6	219.55	34	33.363	74	7.4536	124	1.905
-5	208.28	35	31.977	75	7.2073	125	1.856
-4	197.67	36	30.695	76	6.9704	126	1.808
-3	187.66	37	29.453	77	6.7423	127	1.762
-2	178.22	38	28.269	78	6.5228	128	1.717
-1	168.31	39	27.139	79	6.3114	129	1.674
0	160.90	40	26.061	80	6.1078	130	1.632
1	152.96	41	25.031	81	5.9117		
2	145.45	42	24.048	82	5.7228		
3	138.35	43	23.109	83	5.5409		

TEMPERATURE SENSOR RESISTANCE CHARACTERISTICS

Temp. (°C)	Res. (kΩ)	Temp. (°C)	Res. (kΩ)	Temp. (°C)	Res. (kΩ)	Temp. (°C)	Res. (kΩ)
4	131.64	44	22.212	84	5.3655		
5	125.28	45	21.355	85	5.1965		
6	119.27	46	20.536	86	5.0336		
7	113.58	47	19.752	87	4.8765		
8	108.18	48	19.003	88	4.7251		
9	103.07	49	18.286	89	4.5790		



CLIVET SPA

Via Camp Lonc 25, Z.I. Villapaiera
32032 Feltre (BL) - Italy
Tel. +39 0439 3131 - Fax +39 0439 313300

info@clivet.it
www.clivet.com

MideaGroup
humanizing technology