

User Guide

Temperature controller
for walk-in coolers and freezers
Type **AK-RC 204B, 205C**



Contents	1. Versions and references	3
	2. Warnings	3
	3. Maintenance	3
	4. Description	3
	5. Installation	4
	6. Wiring	5
	7. Initial configuration	5
	8. Operation	6
	8.1 Cold regulation.....	7
	8.2 Door management.....	9
	8.3 Defrost.....	10
	8.4 Defrost control.....	10
	8.5 Fan control.....	11
	8.6 Alarms.....	12
	8.7 Alerts.....	13
	8.8 Light control.....	13
	8.9 Password.....	13
	8.10 Remote Stand-by mode.....	13
	8.11 Operation of the auxiliary relays.....	13
	9. Configuration	14
	10. Technical specifications	19
	11. Ordering	20

1. Versions and references

Model	Description	Power supply	Circuit Breaker Protection
AK-RC 204B	4 relays temperature controller	230 V~ ± 10%, 50 Hz ± 5%	No
AK-RC 205C	5 relays temperature controller	230 V~ ± 10%, 50 Hz ± 5%	Yes (Breaker)

2. Warnings

- Using the unit without observing the manufacturer's instructions may alter the appliance's safety requirements. Only NTC probes supplied by Danfoss should be used for the unit to operate correctly.
- From -40 – +20 °C, if the NTC probe is extended to 1000 m with at least 0.5 mm² cable, the maximum deviation will be 0.25 °C.
- It should be installed in a place protected from vibrations, water and corrosive gases, where the ambient temperature does not exceed the value indicated in the technical data.
- For the reading to be correct, the probe should be used in a place without heat influences apart from the temperature you want to measure or control.
- IP65 protection degree is only valid with the protection cover closed.
- IP65 protection degree is only valid if the cables enter the device using electrical conduit + gland with IP65 or above. The size of the glands should be suitable for the diameter of the conduit used.
- Do not spray the unit directly with high-pressure hoses, as this could cause damage.

Important:

- Before starting the installation, you must take the advice of local regulations in force.**
- The AUXILIARY relays are programmable, and their operation depends on the configuration.
- The function of the digital inputs depends on the configuration.
- The recommended currents and powers are the maximum working currents and powers.

3.0 Maintenance

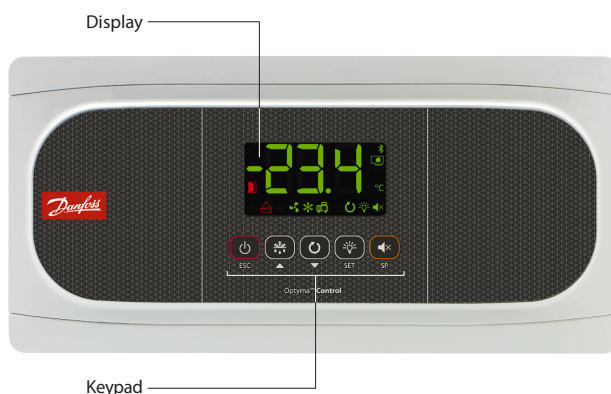

- Clean the surface of the unit with a soft cloth, water and soap.
- Do not use abrasive detergents, gasoline, alcohol or solvents, as this might damage the unit.

4.0 Description





- | | | | |
|--|--|-------|--|
| | Fixed: Stand-by Mode activated. Regulation is paused.
Flashing: Controlled shutdown process for the regulation underway. | | Fixed: Compressor active.
Flashing: The compressor should be active but a delay or protection is preventing this. |
| | Fixed: Cold room door open.
Flashing: The door has been open for a greater time than has been defined in parameter A12 . | | Defrost relay active. |
| | There is an active alarm, but not an active HACCP alarm. | | Continuous cycle mode active. |
| | Fixed: HACCP alarm active.
Flashing: HACCP alarm registered and unconfirmed. Press the key to confirm an HACCP alarm. | | Cold room light active. |
| | Fixed: Evaporator fans active.
Flashing: The evaporator fans should be active but a delay is preventing this. | | Alarm in progress muted. |
| | Fixed: The cold solenoid is active.
Flashing: The solenoid should be active but a delay or protection is preventing this. | °F °C | Temperature displayed in ° Fahrenheit / ° Centigrade. |
| | | PRG | Programming mode active. |

4.1 Keypad

 Pressing it for 3 seconds activates/deactivates Stand-By mode. In this mode, regulation is paused and the power icon  is displayed. In the programming menu, this exits the parameter without saving changes, returns to previous level or exits programming.

 Pressing once displays the temperature of probe S2 for 10 seconds (if it is enabled). Pressing it for 3 seconds starts/stops the defrost. In the programming menu, this allows scrolling around the different levels, or, during the setting of a parameter, changing its value.

 Pressing it for 3 seconds activates/deactivates continuous cycle mode. In the programming menu, this allows scrolling around the different levels, or, during the setting of a parameter, changing its value.

STAND-BY
 If the temperature regulation cannot be instantly stopped due to its configuration, a controlled stop process starts and the  icon flashes. To stop the controlled stop process and force the step to Stand-by, press the Stand-by key again for 3 seconds.

 Pressing once activates/deactivates the cold room light. Pressing it for 3 seconds accesses the condensed programming menu. Pressing it for 6 seconds accesses the expanded programming menu. In the programming menu, this accesses the level shown on the display or, during the setting of a parameter, accepts the new value.

 Pressing once displays the current effective value of the Set Point, taking into consideration temporary modifications by other parameters (**C10** or **C12**). When an alarm is underway, pressing once mutes the acoustic alarm. Pressing for 3 seconds accesses the Set Point setting.

5. Installation

- Remove the bezels (1) by pulling out on one side first and then the other side.
- Make a 1/4 turn of the screws (2) counter-clockwise and open the door (3).
- Install the necessary glands (4) removing the provided caps.
- Mark and make the holes in the wall with the aid of the template included.
- Fix the device to the wall. If it is a brick wall, use the screws and anchors supplied; if the wall is made of sheet metal (cold room store), use the screws provided without anchors (5).
- Remove the plastic cover (7) loosening the screw (6) and wire the device by following the recommendations indicated on p. 7.
- Once the wiring is done, reinstall the plastic cover (7), close the cover (3), tighten the screws (2) and reinstall the bezels (1)

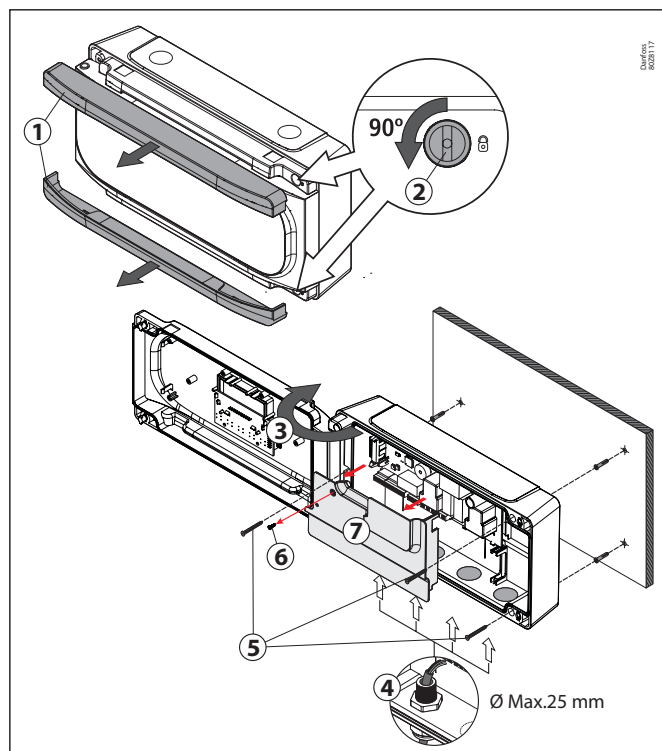

6. Wiring

Always disconnect the power supply to do the wiring. The probes and their cables should **NEVER** be installed in a conduit together with power, control or power supply cables.

For disconnection, the power supply circuit must be equipped with a switch of at least 2 A, 230 V, located near the device. The power supply cable will be H05VV-F or NYM 1x16/3. The section to be used will depend on the local standard in force but must never be less than 2.5 mm².

Cables for relay or contactor outputs should have a section of 2.5 mm², allow working temperatures equal to or over 70 °C and be installed with as few bends as possible.

The 230 V~ wiring must be kept clear of any other external element.

- The specific wiring to be performed depends on the option selected in the initial configuration wizard.
- Use the appropriate diagram based on the option selected.
- Check the available options on the diagram sheet included with your device.

Important:

- Before starting the installation, you must take the advice of local regulations in force.
- The AUXILIARY relays are programmable, and their operation depends on the configuration.
- The function of the digital inputs depends on the configuration.
- The recommended currents and powers are the maximum working currents and powers.

7. Initial configuration

The first time the unit is powered up, it will enter into the Wizard mode. The display will show the message *In1* flashing with **0**.

Step 1:

Select the most suitable *In1* option based on the type of installation to be carried out and press **SET**. The available options will be shown in the following table:

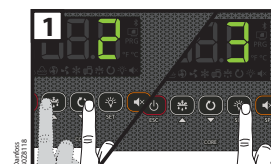

In1	Type of installation				Parameters										Diagram to be used
	Cold regulation	Pump Down	Defrost	Evaporator fans	Pd	o00	I00	I10	I11	I20	I21	d1	d7	F3	
0	Demo Mode: it displays the temp. but does not regulate or activate relays														
1	Solenoid	No	Electric	Yes	0	*	2	0	0	0	0	20	0	0	A
2	Solenoid + compressor	Yes	Electric	Yes	1	1	2	7	1	0	0	20	0	0	B
3	Solenoid + compressor	No	Electric	Yes	0	1	2	0	0	0	0	20	0	0	B
4	Solenoid	No	Air	Yes	0	*	1	0	0	0	0	20	1	1	A
5	Solenoid + compressor	Yes	Air	Yes	1	1	1	7	1	0	0	20	1	1	B
6	Solenoid + compressor	No	Air	Yes	0	1	1	0	0	0	0	20	1	1	B
7	Solenoid + compressor	Yes	Hot gas	Yes	1	1	2	7	1	9	1	5	2	0	C
8	Solenoid + compressor	No	Hot gas	Yes	0	1	2	0	0	9	1	5	2	0	C
9	Solenoid + compressor	Yes	Reversed cycle	Yes	1	1	2	7	1	0	0	5	3	0	D
10	Solenoid + compressor	No	Reversed cycle	Yes	0	1	2	0	0	0	0	5	3	0	D
11	Solenoid	No	Static	No	0	*	1	0	0	0	0	20	1	-	A
12	Solenoid + compressor	Yes	Static	No	1	1	1	7	1	0	0	20	1	-	B
13	Solenoid + compressor	No	Static	No	0	1	1	0	0	0	0	20	1	-	B

* **o00=2** in AK-RC 204B, **o00=0** in AK-RC 205C

Note: If options 2, 5, 7, 9 or 12 are chosen, check the configuration of parameter I11 according to the pressure switch type used. (See diagram included with the device).

Step 2:

Use keys ▲ and ▼ to enter the desired Temperature Set Point value and press **SET**. The wizard has finished. The unit will begin to regulate the temperature.

If this is not the first time you run the wizard, after completing the last step the display will show the message **dFp** (default parameters). You may choose between two options:

0: Only change the parameters which affect the wizard. The other parameters will remain the same.

1: All parameters return to their factory setting except those which have been modified by the wizard.

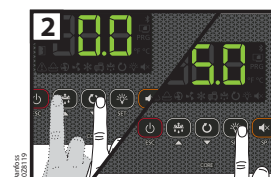

Important: The wizard will not start automatically once the unit has been powered up at least once. To start the Wizard at any time turn off the controller by pressing the power button for 3 seconds and wait until the power symbol is ON. Then press the buttons listed here in sequence ▲, ▼ and **SET**.

If the pump down function is active, a certain amount of time may elapse between starting the stand-by function and the controller stopping (see page 8).

Wizard parameters list

Pd	Pump down active?	0 =No	1 =Yes
o00	Configuration of relay AUX1	0 =Deactivated 2 =Light	1 =Compressor/Crankcase heater 3 =Virtual control 4 =Alarm (only in AK-RC 204B)
I00	Connected probes	1 =Probe 1 (Cold room)	2 =Probe 1 (Cold room) + Probe 2 (Evaporator)
I10	Configuration of digital input 1	0 = Deactivated 3 =Severe external alarm 6 =Defrost block	1 =Door contact 4 =Change of SP 7 = Low pressure switch 2 =External alarm 5 =Remote defrost 8 =Remote Stand-by
I11	Polarity of the digital input 1	0 =Activates on closing contact	1 =Activates on opening contact
I20	Configuration of digital input 2	0 = Deactivated 3 =Severe external alarm pressure switch for Hot Gas	1 =Door contact 4 =Change of SP 7 =Register probe 2 =External alarm 5 =Remote defrost 6 =Defrost 8 =Probe 2° evaporator 9 =High 10 =Remote Stand-by
I21	Polarity of the digital input 2	0 =Activates on closing contact	1 =Activates on opening contact
d1	Maximum defrost duration (0=defrost deactivated)		
d7	Type of defrost	0 =Resistors of cycle	1 =Air/fans 2 =Hot gas 3 =Reversal
F3	Status of the fans during the defrost	0 =Shut down	1 =Running

8. Operation

Display messages	
	Pump down malfunction error (stop), the time configured in parameter C20 has been exceeded (see page 8). Only displayed on screen.
	Pump down malfunction error (start-up), the time configured in parameter C19 has been exceeded (see page 8). Only displayed on screen.
	Probe 1/2/3 failure (open circuit, crossed circuit or temperature outside the limits of the probe) Only E2 and E3: Damp evaporator probe (see page 12). Activates the alarm relay and the audible alarm.
	Open door alarm. Only if the door remains open for a longer time than defined in parameter A12 (see page 12). Activates the alarm relay and the audible alarm.
	Maximum temperature in control probe alarm. The temperature value programmed in A1 has been reached (see page 12). Activates the alarm relay and the audible alarm.
	Minimum temperature in control probe alarm. The temperature value programmed in A2 has been reached (see page 12). Activates the alarm relay and the audible alarm.
	External alarm activated (by digital input) (see page 12). Activates the alarm relay and the audible alarm.
	Severe external alarm activated (by digital input) (see page 12). Activates the alarm relay and the audible alarm.
	Alarm for defrost completed due to time-out. The time set in d1 has been exceeded (see page 13). Activates the alarm relay and the audible alarm.
	HACCP alarm. The temperature has reached the value of parameter h1 during a longer period than established in h2 (see page 12). Activates the alarm relay and the audible alarm.
	HACCP alarm due to a power supply failure. The temperature established in h1 has been reached, following a power supply failure (see page 12). Activates the alarm relay and the audible alarm.

	<p>Indicates that a defrost is being performed (see page 10). Only displayed on screen.</p>
	<p>Password request. See parameters b10 and PAS (see page 13). Only displayed on screen.</p>
	<p>Shown sequentially with the temperature: The controller is in demo mode, the configuration has not been made.</p>

8.1 Cold regulation

Solenoid control (COOL Relay)

The cooling process is regulated by means of opening / closing the solenoid valve.

When the temperature in probe S1 reaches the set point (**SP**) value plus the probe's differential (**C1**), the solenoid opens and causes the temperature to drop. Once the set point (**SP**) value is reached, the solenoid closes.

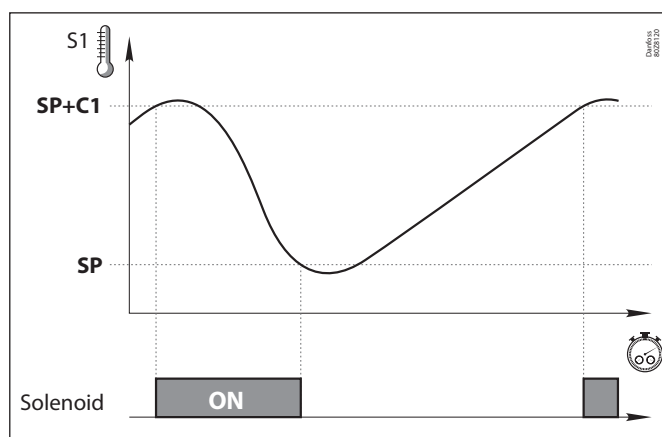

Compressor control (Relay AUX 1)

With Pump Down (**Inl:** 2, 5, 7, 9, 12)

Requires the connection of a low pressure switch in digital input 1.

When the temperature in probe S1 reaches the set point (**SP**) value plus the probe's differential (**C1**), the solenoid opens, causing the pressure in the evaporator to increase and, therefore, the low pressure switch deactivates and the compressor starts up.

Once the set point (**SP**) value is reached, the solenoid closes, causing the pressure in the evaporator to decrease, triggering the low pressure switch and stopping the compressor.

For further details of the process, see page 8.

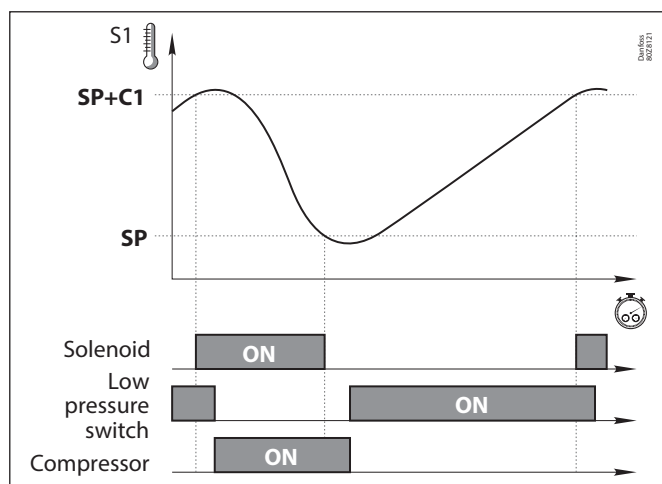

Without Pump Down (**Inl:** 3, 6, 8, 10, 13)

The compressor operates simultaneously with the solenoid valve, starting up when the latter opens and stopping when it closes.

Operation in the event of a fault in probe S1

If probe S1 fails (fault, disconnection, etc.), compressor behavior will depend on parameter **C6**, with one of 3 options available:

- C6=0:** The compressor is stopped until probe S1 begins to operate again.
- C6=1:** The compressor is started-up until probe S1 begins to operate again
- C6=2:** The compressor operates in line with the average operation during the 24 hours prior to the error, taking into account the number of start-ups and stops and the average time in each state (stop-start). If 24 hours have not elapsed without a probe error, the device moves to **C6=3** mode.
- C6=3:** The compressor operates in line with the times programmed in **C7** (ON) and **C8** (OFF).

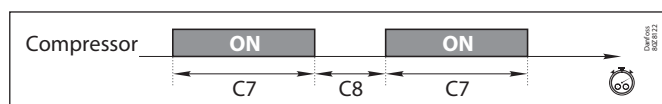

Pump down function

This function provides direct control of the solenoid and the compressor and requires the use of a low pressure switch connected to the digital input 1. It prevents pressure problems in the system by ensuring that the compressor operates only when the pressure is within the correct range. Use only if controlling both, the solenoid valve and the compressor. If controlling only the solenoid valve, DO NOT USE THIS SETTING and use any other of the options as it will trigger an error if the low pressure switch is not connected.

This function is only available for InI options 2, 5, 7, 9 and 12

STOP

When the temperature in probe S1 reaches the set point (SP) value, the COOL relay deactivates, closing the liquid solenoid. Because the compressor continues to operate, pressure in the evaporator quickly drops. Upon reaching a given value, the low pressure switch activates, changing the status of digital input 1, which stops the compressor (relay AUX 1).

This action isolates all of the refrigerant in the high-pressure line, far from the compressor crankcase, preventing serious faults upon start-up.

Should the low pressure switch fail, the controller stops the compressor once the safety interval defined in C20 has elapsed, displaying the message "Pd" (an informative message that does not affect the unit's operation).

If C20 time is 0 (default value), the compressor will not stop until the low pressure switch is activated, but it will display the "Pd" message after 15 minutes.

START

When the temperature in probe S1 reaches the set point value plus the differential (SP+C1), the COOL relay activates, opening the liquid solenoid. This increases the pressure in the evaporator, deactivating the low pressure switch, which turns the compressor on.

If, some time (determined by C19) after the liquid solenoid is opened (COOL relay set to ON), the low pressure switch does not deactivate, the controller will once again close the solenoid (COOL relay set to OFF) and the "LP" message will be displayed. This action will be repeated every 2 minutes, indefinitely, until the pressure switch is deactivated and the installation reverts to its normal operation.

If C19 time is 0 (default value), the solenoid will remain open until the low pressure switch deactivates, but it will display the "LP" message after 5 minutes.



STAND-BY

If the pump down function is active, a certain amount of time may elapse between starting the stand-by function and the controller stopping; this is because certain installation control phases cannot be interrupted.

To force the stop of the controller, press the Stand-by key again for 3 seconds.

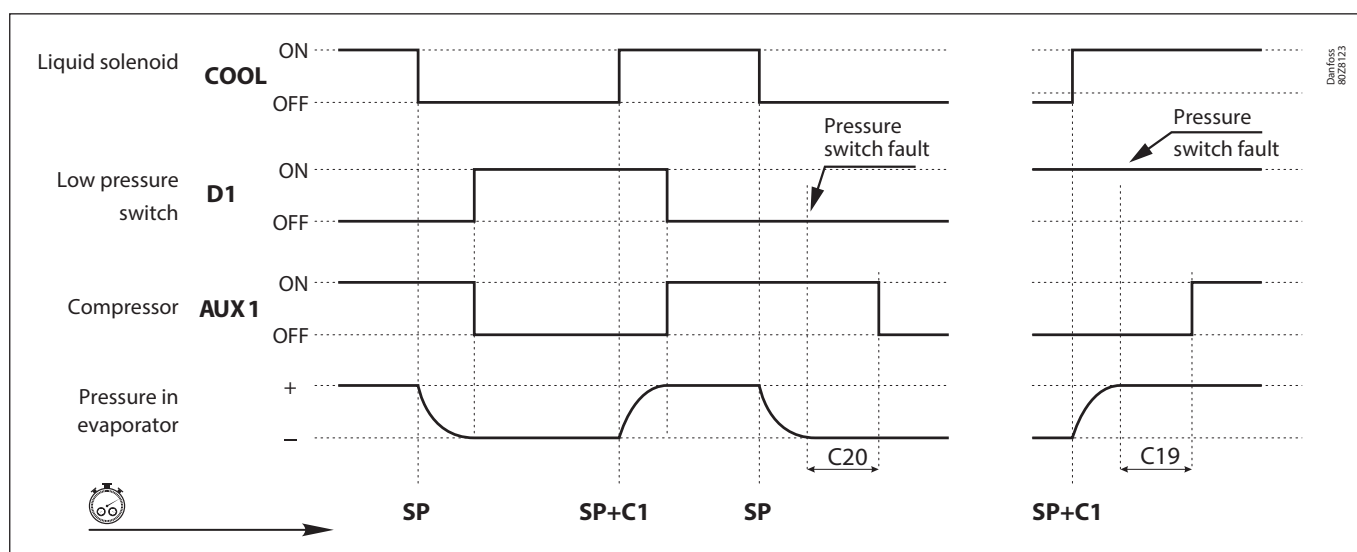

Continuous cycle mode

This is used to quickly cool the cold room stores before products are loaded and is activated by pressing the key for 3 seconds.

Upon activating this mode, the compressor begins to operate until the temperature in probe S1 reaches the set point value, minus the variation indicated in parameter C10. The value of C10 is always negative, unless it is 0.

The unit will immediately return to normal operation. Should it not be possible to reach this point, the device will return to normal operation once the time configured in C9 has elapsed, or by pressing the key again for 5 seconds.

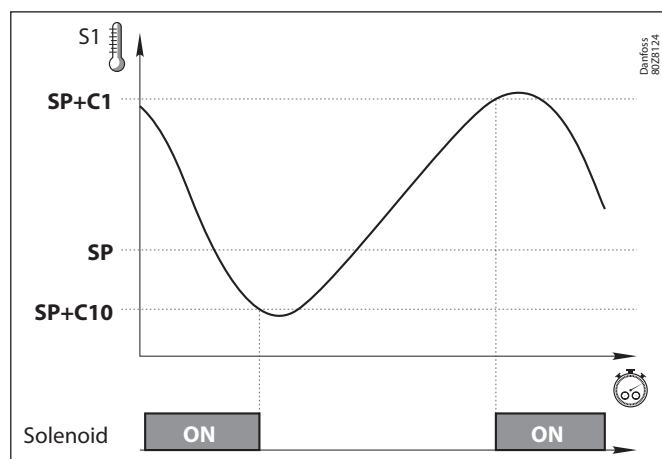

Set Point change mode

This allows for quick alternation between two working temperatures in the cold room store, modifying the Set Point in line with the value indicated in parameter **C12**. The aforementioned value may be negative or positive, which allows for the Set Point to be reduced or increased. If it is configured in 0, the mode is disabled.

It can be activated as follows:

- By means of an external switch connected to one of the digital inputs. The digital input should be configured as "Set Point change (I10 or I20=4). Activation through this method cancels any other activation and can only be deactivated using the same method.

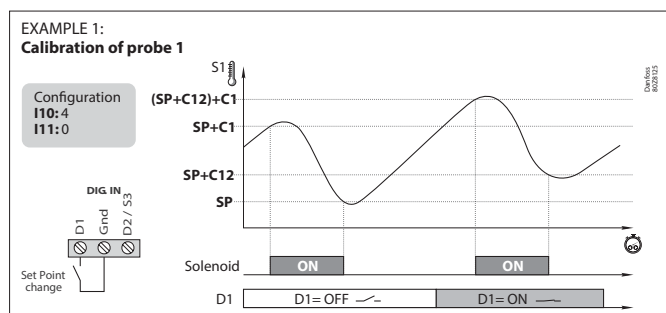

Parameter **C0** allows for correction of the temperature detected by probe 1; this is particularly useful when the probe cannot be located in the ideal place.

Set Point locking

Parameters **C2** and **C3** allow for an upper and lower limit to be established for the set point (**SP**), to protect the product or installation from Set Point manipulation.

Compressor protection timing

Parameter **C4** allows for selection of the type of timing to be applied to protect the compressor. These delays prevent continuous compressor starts and stops.

These timings affect the COOL and AUX 1 relays (if o00=1)

OFF-ON (C4=0): Minimum time in OFF mode before each start-up.

OFF-ON / ON-OFF (C4=1): Minimum time in ON and OFF mode for each cycle. The delay time is defined by means of parameter **C5**; if **C5=0**, timing is disabled.

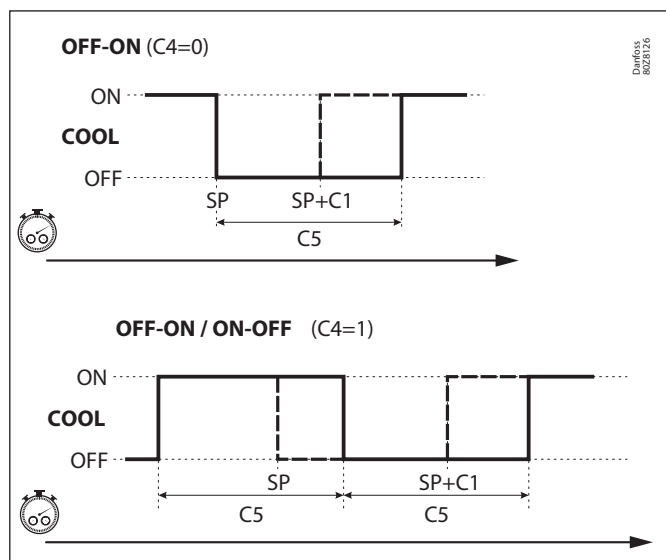

8.2 Door management

Door management allows for the installation's behavior to be controlled, should the cold room door open through parameters **C22** and **C23**.

Parameter **C22** defines whether cooling should be stopped if the door opens. If **C22=1**, when the door opens, the fans stop and, 15 seconds later, the solenoid closes (COOL relay).

Parameter **C23** defines the maximum time, in minutes, that the installation can remain without cooling whilst the door is open. If **C23=0**, cooling does not occur with the door open.

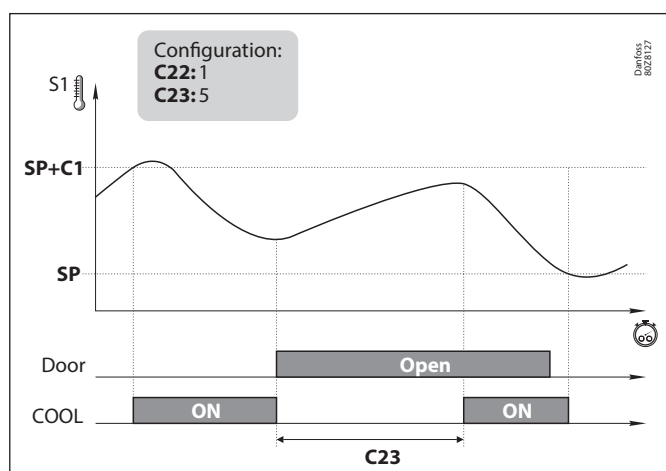

Management of door frame resistor

If the Set Point is equal to or below -4 °C and the relay AUX 2 has been configured as "door frame resistor" (o10=4), the resistor is activated (relay ON) when the temperature of the cold room drops below -3 °C, and is deactivated (relay OFF) when 0 °C is reached.

8.3 Defrost

Types of defrost

There are 5 possible defrost types, depending on the option selected in the wizard (InI):

Electric (InI=1, 2 and 3) (d7=0)

Defrost is performed through electrical resistors, supplying the evaporator with heat. The operation of fans in this mode depends on parameter **F3**; the compressor and solenoid are stopped.

By air (InI=4, 5 and 6) (d7=1)

Usually used in positive cold rooms (> 37 °F), since the inside temperature of the cold room is sufficient to melt evaporator ice. By default, the fans are activated so that air may circulate through the evaporator; to stop them, change parameter F3 to 0. The compressor and solenoid are stopped.

Static (InI=11, 12 and 13)

In this type of installation, there are no evaporator fans and defrost is performed by stop cooling.

Hot gas (InI=7 and 8) (d7=2)

The hot gas from compressor discharge is used to melt evaporator ice and, to this end, two valves are necessary: one at the condenser input (A) (SSV relay) and another between the compressor output and the evaporator input (B) (DEF relay).

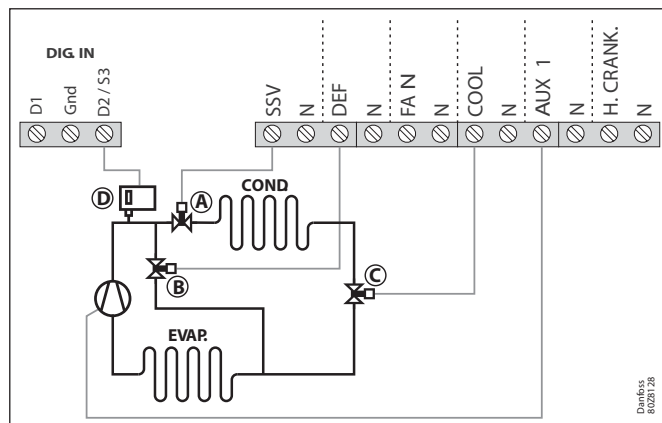

During the process, the liquid solenoid valve (C) and the condenser input valve are closed and the evaporator input valve is opened, forcing hot gas to pass through the latter and melting the ice.

Optionally, a high pressure switch (D) can be added to control the solenoid valve (digital input D2, I20=9) during the defrost process using hot gas. If the pressure decreases, the solenoid opens to allow liquid into the tank; when the pressure rises again, the solenoid closes.

Reversed cycle (InI=9 and 10) (d7=3)

A 4-way valve is used to invert the refrigeration cycle, using the evaporator as a condenser to melt the ice formed. The process begins by stopping the cooling process (if it is active). If Pump Down is active, defrost begins once the action is complete.

Next, the 4-way valve is activated (DEF relay ON), alongside the solenoid (COOL relay ON) and the compressor (AUX 1 ON), and the defrost process begins. D1 time begins to be counted after the COOL relay is activated.

When defrost is complete, the action can be stopped in two possible ways:

- Pump down active (InI=9): The solenoid closes (COOL relay OFF) and the 4-way valve returns to its initial position (DEF relay OFF) while the compressor continues to operate (AUX 1 relay ON), until the low pressure switch activates, stopping the compressor (AUX 1 relay OFF), starting the drip time.
- Without Pump Down (InI=10): The solenoid closes (COOL relay OFF) and the 4-way valve returns to its initial position (DEF relay OFF) and the compressor stops (AUX 1 relay OFF), starting the drip time.

8.4 Defrost control

Defrost start

Defrost will start if:

- The time programmed in parameter **d0** has elapsed since the start of the last defrost.
- We press the key for 3 seconds.
- By means of an external push-button (I10 / I11=5).

Defrost completion

Defrost will complete if:

- The temperature programmed in parameter **d4** has been reached in probe 2. This requires a 2nd probe (I00=2) to be available, located in the evaporator.
- The time configured in parameter **d1** has elapsed (maximum defrost duration).
- We press the key for 5 seconds.
- By means of an external push-button (I10 / I11=5).

Drip time

This is established through parameter **d9** and sets the time added at the end of defrost to allow for the removal of surplus water from melted evaporator ice, during which there is no cooling.

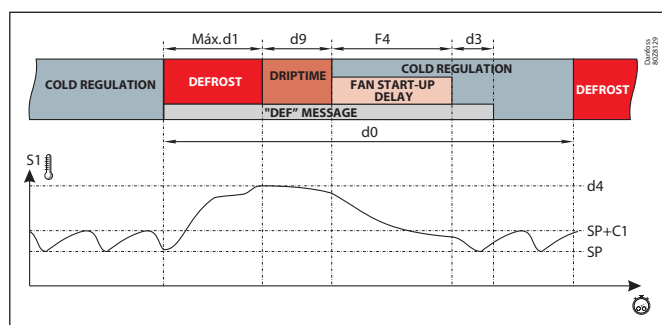

Fan start-up delay

This is established through parameter **F4** and allows for the possible drops left in the evaporator to freeze before the fans activate, preventing them from being projected into the cold room. It also prevents heat being supplied to the cold room due to defrost in the evaporator.

Note: If defrost is cancelled before 1 minute has elapsed, the drip time (**d9**) is not applied and the fans are activated without taking into account the start-up delay (**F4**).

If defrost is by air or is static, the drip time (**d9**) and fan start-up delay (**F4**) are deactivated.

Message displayed during defrost

This is established using parameter **d2**, and you can choose between displaying the real temperature captured by probe 1 (**d2=0**), showing the temperature captured by probe 1 at the start of the defrost (**d2=1**), or displaying the dEF (**d2=2**) message. Parameter **d3** defines the time during which the aforementioned message will be displayed once the drip time (**d9**) and fan stop time (**F4**) are complete.

Remote defrost

This function allows defrost of the unit to be activated using an external button, connecting it to one of the digital inputs that must be configured as remote defrost (**I10** or **I20=5**).

Defrost locking

This prevents defrost starting at unusual points by means of an external switch, which may be useful for ensuring that the installation's load does not excessively increase, exceeding the permitted limits.

The external switch must be connected to one of the digital inputs, which should be configured as "Defrost locking" (**I10** or **I20=6**).

Defrost of a second evaporator

This function allows for defrost to be controlled in a second evaporator, provided that defrost is by electric heat, by air or is static. The same type of defrost should be used for the first and second evaporators.

This requires configuration of input 2 as a 2nd evaporator probe (**I20=8**). In the event of an error in the 2nd evaporator probe, defrost completes once the time defined in **d1** has elapsed.

Electric defrosting

This requires configuration of relay AUX 2 as 2nd evaporator defrost (**o10=5**).

Defrost begins simultaneously in both evaporators. When the probe of evaporator 1 reaches the temperature defined in **d4**, the DEF relay deactivates, completing defrost of evaporator 1. Defrost of evaporator 2 is completed when the evaporator 2 probe reaches the temperature defined in **d4**. Drip time begins when both defrosts are complete.

Defrost by air

The fans of both evaporators are connected in parallel to the FAN relay.

Defrost begins simultaneously in both evaporators and does not complete until both probes reach the temperature defined in **d4**. Drip time subsequently begins.

Static defrost

Defrost begins simultaneously in both evaporators and does not complete until both probes reach the temperature defined in **d4**. Drip time subsequently begins.

Other parameters

Using parameter **d5**, you can configure whether the unit performs a defrost (**d5=1**) or not (**d5=0**) when it receives power (first start-up or after a power supply failure). Should the option YES (**d5=1**) be selected, defrost will begin once the delay time defined in **d6** has elapsed.

Using parameter **d8**, we define the time tally established in **d0**, choosing between total time elapsed (**d8=0**) or the sum of compressor operation time (**d8=1**).

Remark: If parameter **d1** is configured to 0, no defrosts are performed.

8.5 Fan control

Fans are controlled through probe 2 (evaporator) and parameters **F0** (stop temperature) and **F1** (probe differential). If probe 2 is not connected or an error in the probe (**E2**) is detected, the fans continuously operate without taking into account parameters **F0** and **F1**, but taking the remaining parameters (**F2** to **F4**) into account.

Using parameter **F2**, the status of the fans during compressor stops is defined. Using parameter **F3**, the status of the fans during defrost is defined.

Parameter **F4** defines the fan start-up delay time after defrost. Parameter **C22** defines whether fans stop when the door is opened.

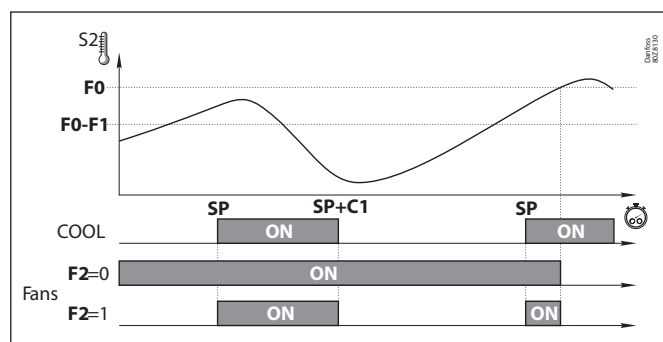

8.6 Alarms

The device warns the user through an on-screen message, activation of a relay (only units with 5 relays if $\text{o10}=1$ or units with 4 relays if $\text{o00}=4$) and a sound alarm when the criteria programmed in the parameters are met.

Maximum / minimum temperature alarm

It shows the message "AH" or "AL" when the temperature in probe 1 reaches the value configured in parameters **A1** (maximum temperature) and **A2** (minimum temperature).

This value may be:

- Absolute (**A0=1**): The temperature at which the alarm should activate must be indicated in **A1/A2**.
- Relative to the SP (**A0=0**): The increase or decrease in the number of degrees necessary for the alarm to activate, in relation to the set point, must be indicated in **A1/A2**. This option enables us to change the set point without having to reset the maximum and minimum alarms.

Parameter **A10** establishes the differential of both parameters (Hysteresis).

Note: We configure the following parameters in a controller: **SP=2**, **A1=10**, **A10=2**

- If **A0=0** (Relative to the SP), the maximum temperature alarm will activate when 12 degrees are reached in probe 1, and will deactivate when 10 degrees are reached.
- If **A0=1** (Absolute), the maximum temperature alarm will activate when 10 degrees are reached in probe 1, and will deactivate when 8 degrees are reached.

External alarm / severe external alarm



The message **AE** (External alarm) or **AES** (Severe external alarm) is displayed when the digital input configured as external alarm or severe external alarm is activated.

The severe external alarm also deactivates all the loads and, therefore, temperature regulation stops. When this alarm disappears, the device returns to its normal operation.

At least one of the digital inputs must be configured as an external alarm (**I10** or **I20=2**) or as a severe external alarm (**I10** or **I20=3**).

Probe error alarm



If one of the enabled probes is crossed, in open circuit or out of range, the message E1, E2 or E3 will be shown, depending on whether probe S1, S2 or S3 is involved.

Evaporator probe error alarm due to moisture ingress



If, at the start of defrost, the temperature in probe S2 is 20 °C higher than the temperature in probe S1, the controller ignores probe S2 and defrost is instead completed based on defrost time.

The display shows the message **E2**, activates the alarm relay and sound alarm.

The alarm can be silenced, but the **B** alarm icon will not disappear until:

- The controller is switched off and then on again.
- Defrost without error is started in probe **S2**.

If the 2nd evaporator probe (**I20=8**) has been enabled, it will behave in the same way, but displaying the message **E3**.

Open door alarm



The door has been open for a longer time than defined in parameter **A12**, the open door alarm is activated.

In order to detect the open door, configuration is required of one of the digital inputs as "door contact" (**I10** or **I20=1**).

Activates alarm relay and sound alarm.

HACCP alarm



The alarm is activated should situations be detected which could endanger the integrity of the products stored in the cold room.

If the temperature of the cold room is higher than that defined in parameter **h1** for a length of time exceeding that defined in parameter **h2**, the alarm activates, displaying the message HCP on screen.

Upon pressing the mute key, the sound alarm switches off, but the alarm remains.

Once the temperature drops below parameter **h1**, if the mute key has been pressed, the alarm disappears. If the mute key has not been pressed, the audible alarm deactivates but the HACCP indicator remains in flashing mode, indicating that a non-confirmed HACCP alarm has occurred.

Press the mute key to confirm an HACCP alarm.

If, during a power failure, a HACCP alarm occurs, when the power supply returns, the HACCP alarm is activated and the display shows the messages HCP and PF (power failure) alternately.

Alarm delays

These delays prevent certain alarms from being shown, to allow the installation to recover its normal operation after certain events.

- Delays in start-up (A3): This delays the activation of the temperature alarms upon receiving power (at start-up or after a power supply failure) or when exiting Stand-by mode. This allows for the installation to start up avoiding alarms.
- Delay after a defrost (A4): This delays the activation of the temperature alarms when a defrost completes.
- Delay to minimum and maximum temperature alarm (A5): This delays the activation of the maximum (A1) and minimum (A2) temperature alarms, from when the temperature in probe 1 reaches the programmed value.
- Delay to activation of external alarm (A6): This delays the activation of the external alarm, from when the digital input becomes active.
- Delay to deactivation of external alarm (A7): This delays the deactivation of the external alarm, from when the digital input becomes active.
- Delay to open door alarm (A12): This delays the activation of the alarm upon detecting that the door is open.

Configuration of alarm relay

Should any relay have been configured as an alarm relay, parameter **A9** allows for the relay status to be defined when an alarm is triggered:

- **A9=0** Relay active (ON) in the event of an alarm (OFF without alarm)
- **A9=1** Relay inactive (OFF) in the event of an alarm (ON without alarm)

8.7 Alerts

The device alerts the user through an on-screen message when an event occurs which requires his/her attention. However, it does not activate the sound alarm or the alarm relay (if active).

Defrost finished by time alarm

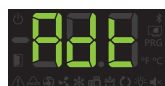

The message **Adt** is displayed when a defrost has completed due to time-out, if parameter **A8=1**.

Pump down malfunction error (stop)



The message **Pd** is displayed if a malfunction is detected when the refrigeration system is stopped using the pump down action. (See page 8).

Pump down malfunction error (start-up)



Displays the **LP** message if a malfunction is detected when the refrigeration cycle is started up using the pump down action. (See page 8).

8.8 Light control

Relay AUX 1 or AUX 2 must be configured as "Light" (**o00** or **o10=2**).

Switching the lights on or off is controlled using:

The push-button: One press switches the lights on or off.

The cold room door: When the door is opened, the lights remain on for the time defined by parameter **b01**. If the value is 0, when the door closes the lights go out. (One of the digital inputs must be configured as door contact (**I10** or **I20=1**).

The control even occurs with the equipment in Stand-by.

8.9 Password



It allows protecting the configuration of the unit using a 2 digit code (from 01 to 99). If it is active a code is requested when you try to access the programming menu. This menu cannot be accessed if a wrong value is entered. The code is set via the **PAS** parameter. Parameter **b10** defines the operation of this code.

8.10 Remote Stand-by mode

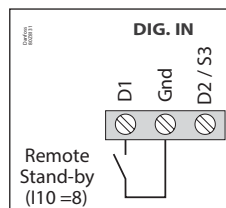

This allows activating Stand-by mode using a switch connected to one of the digital inputs. Said digital input must be set to Stand-by remote activation (**I10=8** or **I20=12**).

8.11 Operation of the auxiliary relays

Depending on the controller model, it may have 1 or 2 auxiliary relays. The function of these relays is configurable through the parameters menu.

AUX 1 relay

- **Deactivated (o00=0)**: It does not carry out any function.
- **Compressors / crankcase resistor (o00=1)**: Controls compressor operation. When the compressor is not in operation, it powers the crankcase resistor. This function can only be selected via the initial wizard (Inl).
- **Light (o00=2)**: This regulates the operation of cold room light.

AUX 2 relay

- **Deactivated (o10=0)**: It does not carry out any function.
- **Alarm (o10=1)**: This activates the relay every time that an alarm occurs
- **Light (o10=2)**: This regulates the operation of cold room light
- **Door frame resistor (o10=4)**: This controls the operation of the cold room's door frame resistor.
- **Defrost 2° evaporator (o10=5)**: This controls the defrost resistors of a second evaporator.
- **Same as solenoid status (o10=6)**: Imitates solenoid status: active if the solenoid is in ON mode, inactive if the solenoid is in OFF mode.
- **Same as unit status (o10=7)**: Indicates the unit's status: active if the unit is in ON mode, inactive if the unit is in Stand-by mode.

9. Configuration

Condensed programming menu

This allows for the most-used parameters to be quickly configured. Press the **SET** key for 3 seconds to access it.

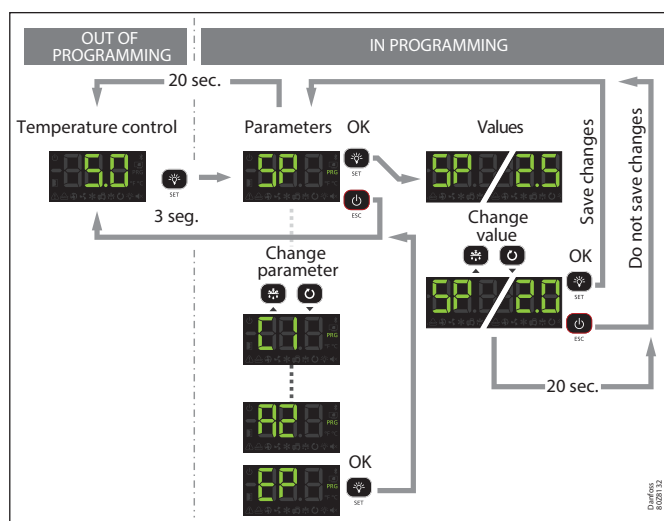

Parameters

Level 2	Description	Values	Min.	Def.	Max.
SP	Temperature setting (Set Point)	°C/°F	-50	0.0	99
C1	Probe 1 differential (Hysteresis)	°C/°F	0.1	2.0	20.0
d0	Defrost frequency (Time between 2 starts)	H.	0	6	96
d1	Maximum defrost duration (0=defrost deactivated)	Min.	0	*	255
d4	Final defrost temperature (by probe) (If I00 ≠1)	°C/°F	-50	8.0	50
F3	Status of the fans during the defrost 0=Shut down; 1=Running		0	0	1
A1	Alarm for maximum in probe 1 (It should be higher than the SP)	°C/°F	A2	99	99
A2	Alarm for minimum in probe 1 (It should be lower than the SP)	°C/°F	-50	-50	A1

Extended programming menu

Use the extended programming menu to configure all of the unit's parameters in order to adapt it to your installation requirements. Press the **SET** key for 6 seconds to access it.

Important:

- If the password function has been configured as a keypad lock (b10=2), or as an access to parameters block (b10=1), you will be requested to enter the password programmed in **PAS** when attempting to access either of the two functions. If the entered password is not correct, the unit will go back to showing the temperature.
- Certain parameters or menus may not be visible depending on the configuration of the rest of the parameters.

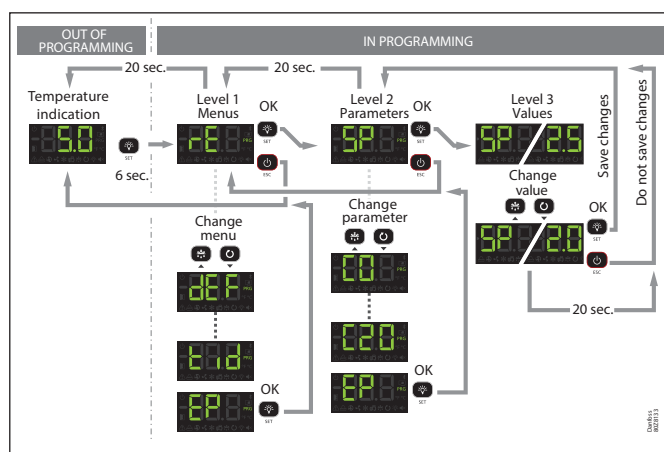

Regulation and control

Level 1	Level 2	Description	Values	Min.	Def.	Max.	
rE	SP	Temperature setting (Set Point)	°C/°F	-50	0.0	99	
	C0	Probe 1 calibration (Offset)	°C/°F	-20.0	0.0	20.0	
	C1	Probe 1 differential (Hysteresis)	°C/°F	0.1	2.0	20.0	
	C2	Set Point top locking (it cannot be set above this value)	°C/°F	C3	99	99	
	C3	Set Point bottom locking (it cannot be set below this value)	°C/°F	-50	-50	C2	
	C4	Type of delay for the protection of the compressor: 0 =Minimum time of compressor in OFF 1 =Minimum time of compressor in OFF and in ON in each cycle			0	0	1
	C5	Protection delay time (Value of the option selected in parameter C4)	Min.	0	0	120	
	C6	COOL relay status with fault in probe 1: 0 =OFF; 1 =ON; 2 =Average according to last 24 h prior to probe error 3 =ON-OFF according to prog. C7 and C8			0	2	3
	C7	Relay time in ON in the event of probe 1 failure (If C7=0 and C8≠0, the relay will always be disconnected in OFF)	Min.	0	10	120	
	C8	Relay time in OFF in the event of probe 1 failure (If C8=0 and C7≠0, the relay will always be connected in ON)	Min.	0	5	120	
	C9	Maximum duration of the continuous cycle mode. (0 =deactivated)	H.	0	0	48	
	C10	Variation of the Set Point (SP) in continuous cycle mode. When it reaches this point (SP+C10), it reverts to the normal mode. (SP+C10 ≥ C3). The value of this parameter is always negative, unless it is 0. (0 =OFF)	°C/°F	0	-50	C3-SP	
	C12	Variation of the Set Point (SP) when the change Set Point function is active. (SP+C12 ≤ C2) (0 = deactivated)	°C/°F	C3-SP	0.0	C2-SP	
	C19	Maximum start time from Pump Down (Values between 1 and 9 seconds will not be accepted) (0 =deactivated)	Sec.	0	0	120	
	C20	Maximum time for pump down (0 = deactivated)	Min.	0	0	15	
	C21	Probe to be displayed 0 =All probes (sequential) 1 =Probe 1 (Cold Room), 2 =Probe 2 (Evaporator), 3 =Probe 3 (According to I20)			0	1	3
	C22	Stop fans and compressor on opening door 0 =No, 1 =Yes			0	0	1
	C23	Start-up delay for fans and compressor with door open	Min.	0	0	999	
C27	Probe 3 calibration (Offset)	°C/°F	-20.0	0.0	20.0		
EP	Exit to level 1						

Defrost

Level 1	Level 2	Description	Values	Min.	Def.	Max.	
dEF	d0	Defrost frequency (Time between 2 starts)	H.	0	6	96	
	d1	Maximum defrost duration (0 =defrost deactivated)	Min.	0	*	255	
	d2	Type of message during the defrost: 0 =Displays the real temperature; 1 =Displays the temperature at the start of the defrost; 2 =Displays the dEF message			0	2	2
	d3	Maximum duration of the message (Time added at the end of the defrost process)	Min.	0	5	255	
	d4	Final defrost temperature (by probe) (If I00 ≠ 1)	°C/°F	-50	8.0	50	
	d5	Defrost on connecting the unit: 0 =NO First defrost according to d0; 1 =YES, First defrost according to d6			0	0	1
	d6	Delay of the defrost start on connecting the unit	Min.	0	0	255	
	d7**	Type of defrost: 0 =Resistors; 1 =Air/fans, 2 =Hot gas; 3 =Reversal of cycle			0	*	3
	d8	Count of time between defrost periods: 0 =Total real time, 1 =Sum of compressor connected time			0	0	1
	d9	Drip time when completing defrost (Shutdown of compressor and fans)	Min.	0	1	255	
	EP	Exit to level 1					

* According to wizard.

** It can only be modified using the configuration wizard (InI).

Evaporator fans

Level 1	Level 2	Description	Values	Min.	Def.	Max.
FAn	F0	Shutdown temperature of fans	°C/°F	-50	45	122
	F1	Probe 2 differential if fans are shut down	°C/°F	0.1	2.0	36
	F2	Shut down fans when the compressor shuts down 0 =No, 1 =Yes		0	0	1
	F3	Status of the fans during the defrost 0 =Shut down; 1 =Running		0	0	1
	F4	Delay of start-up after defrost (If F3=0) It will only actuate if it is higher than d9	Min.	0	2	99
	EP	Exit to level 1				

Alarms

Level 1	Level 2	Description	Values	Min.	Def.	Max.
AL	A0	Configuration of the temperature alarms 0 =Relative to SP 1 =Absolute		0	1	1
	A1	Alarm for maximum in probe 1 (It should be higher than the SP)	°C/°F	A2	99	99
	A2	Alarm for minimum in probe 1 (It should be lower than the SP)	°C/°F	-50	-50	A1
	A3	Delay of temperature alarms in the start-up	Min.	0	0	120
	A4	Delay of temperature alarms from the end of a defrost	Min.	0	0	99
	A5	Delay of temperature alarms from when the A1 or A2 value is reached		0	30	99
	A6	Delay of the external alarm/Severe external alarm on receiving a signal in digital input (I10 or I20 =2 or 3)	Min.	0	0	120
	A7	Delay of external alarm deactivation/Severe external alarm deactivation when the signal in digital input disappears (I10 or I20 =2 or 3)	Min.	0	0	120
	A8	Show warning if the defrost ends for maximum time, 0 =No, 1 =Yes		0	0	1
	A9	Relay alarm polarity 0 = Relay ON in alarm (OFF without alarm); 1 = Relay OFF in alarm (ON without alarm)		0	0	1
	A10	Differential of temperature alarms (A1 and A2)	°C/°F	0.1	1.0	20.0
	A12	Delay of open door alarm (If I10 or I20 =1)	Min.	0	10	120
	EP	Exit to level 1				

Basic configuration

Level 1	Level 2	Description	Values	Min.	Def.	Max.
bcn	b00	Delay of all functions on receiving power supply	Min.	0	0	255
	b01	Cold room light timing	Min.	0	0	999
	b10	Function of password 0 =Inactive, 1 =Block access to parameters, 2 =Block keypad		0	0	2
	PAS	Access code (Password)		0	0	99
	b20	MODBUS address		0	0	247
	b21	Communication speed: 0 =9600 bps, 1 =19200 bps, 2 =38400 bps, 3 =57600 bps	bps	0	2	3
	b22	Acoustic alarm enabled: 0 = No, 1 =Yes		0	1	1
	Unt	Work units: 0 =°C, 1 =°F		0	1	1
	EP	Exit to level 1				

Inputs and outputs

Level 1	Level 2	Description	Values	Min.	Def.	Max.
In0	I00	Connected probes 1=Probe 1 (Cold room), 2=Probe 1 (Cold room) + Probe 2 (Evaporator)		1	2	2
	I10**	Configuration of digital input 1 0= Deactivated, 1=Door contact, 2=External alarm, 3=Severe external alarm, 4=Change of SP, 5=Remote defrost, 6=Defrost block, 7= Low pressure switch, 8=Remote Stand-by		0	*	8
	I11	Polarity of the digital input 1 0=Activates on closing contact; 1=Activates on opening contact		0	*	1
	I20	Configuration of digital input 2 0= Deactivated, 1=Door contact, 2=External alarm, 3=Severe external alarm, 4=Change of SP, 5=Remote defrost, 6=Defrost block, 7=Register probe, 8=Probe 2° evaporator, 9=High pressure switch for Hot Gas, 10=Remote Stand-by		0	0	10
	I21	Polarity of the digital input 2 0=Activates on closing contact; 1=Activates on opening contact		0	0	1
	O00**	Configuration of relay AUX1 0=Deactivated, 1=Compressor/Resistor sump, 2=Light, 3=Virtual control, 4=Alarm (only AK-RC 204B)		0	*	4
	O10	Configuration of relay AUX2 0=Deactivated, 1=Alarm, 2=Light, 3=Virtual control, 4=Door frame resistance, 5=Defrost 2° evaporator, 6=Same as solenoid status, 7=Same as unit status		0	2	7
	EP	Exit to level 1				

* According to wizard.

** It can only be modified using the configuration wizard (InI).

HACCP alarm

Level 1	Level 2	Description	Values	Min.	Def.	Max.
HCP	h1	Maximum temperature of HACCP alarm	°C/°F	-50	99	99
	h2	Maximum permitted time for activation of the HACCP alarm (0=Disabled)	H.	0	0	255
	EP	Exit to level 1				

Information (reading only)

Level 1	Level 2	Description	Values	Min.	Def.	Max.
tid	InI	Option chosen in the configuration wizard				
	Pd**	Pump down active? 0=No, 1=Yes				
	PU	Program version				
	Pr	Program revision				
	bU	Bootloader version				
	br	Bootloader revision				
	PAr	Parameter map revision				
	EP	Exit to level 1				

** It can only be modified using the configuration wizard (InI).

Messages

Messages		A	R
Pd	Pump down malfunction error (Shutdown)		
LP	Pump down malfunction error (Start-up)		
E1/E2/E3	Probe 1/2/3 failure (Open circuit, crossed circuit or temperature outside the limits of the probe)	•	•
Ad0	Open door alarm. Only if the door stays open for a greater time than is indicated in parameter A12	•	•
AH	Maximum temperature alarm in control probe. The temperature value programmed in A1 has been reached	•	•
AL	Minimum temperature alarm in control probe. The temperature value programmed in A2 has been reached	•	•
AE	External alarm activated (by digital input)	•	•
AES	Severe external alarm activated (by digital input)	•	•
Adt	Defrost alarm concluded due to time-out. The time established in d1 has been exceeded		
HCP	HACCP alarm. The temperature has reached the value of parameter h1 during a longer period than has been established in h2	•	•
hCP + PF	HACCP alarm due to a fault in the power supply. The temperature established in h1 has been reached following a fault in the power supply	•	•
dEF	Indicates that a defrost is being performed		
PAS	Access code (Password) request. See parameters b10 and PAS		
S1 - S2	Shown sequentially with the temperature: The controller is in demo mode, the configuration has not been made.		

A: Activates the acoustic alarm

R: Activates the alarm relay

10. Technical specifications

Features		Specifications
Power supply		230 V~ ± 10%, 50 Hz ± 5%
Maximum input power in the operation		6.3 VA
Maximum nominal current		15 A
Relay DEFROST - SPDT - 20 A	NO	EN60730-1: 15 (15) A 250 V~
	NC	EN60730-1: 15 (13) A 250 V~
Relay FAN - SPST - 16 A		EN60730-1: 12 (9) A 250 V~
Relay COOL - SPST - 16 A		EN60730-1: 12 (9) A 250 V~
Relay AUX 1 - SPDT - 20 A	NO	EN60730-1: 15 (15) A 250 V~
	NC	EN60730-1: 15 (13) A 250 V~
Relay AUX 2 - SPDT - 16 A	NO	EN60730-1: 12 (9) A 250 V~
	NC	EN60730-1: 10 (8) A 250 V~
No. of relay operations		EN60730-1:100.000 operations
Probe temperature range		-58 – +99,9 °C
Resolution, setting and differential		0.1 °C
Thermometric precision		±1 °C
Loading tolerance of the NTC probe at 25 °C		±0.4 °C
Working ambient temperature	AK-RC 204B	-10 – +50 °C
	AK-RC 205C	-10 – +45 °C
Storage ambient temperature		-30 – +60 °C
Protection degree		IP65
Pollution degree		II s/ EN 60730-1
Control device classification		Built-in assembly, with Type 1.B automatic operation action feature, for use in clean situations, logical support (Software) class A and continuous operation. Double isolation between power supply, secondary circuit and relay output.
Temperature during ball-pressure test		Accessible parts: 75 °C Parts which position active elements: 125 °C
Current of radio jamming suppression tests		270 mA
Voltage and current as per EMC tests		207 V, 17 mA
Type of assembly		Fixed internal
MODBUS address		Shown on label
Dimensions		290 mm (W) x 141 mm (H) x 84.4 mm (D)
Internal buzzer		Yes

11. Ordering

Controller

Model	Description	Comments	Code no.
AK-RC 204B	AK-RC 204B Gen. 2,5 O/P, Single phase	Includes: • 1 x 1.5 m, NTC 10K sensor • 1 x 3 m, NTC 10K sensor	080Z5001
AK-RC 205C	AK-RC 205C Gen. 2,5 O/P, Single phase		080Z5002

Accessories (for spares and replacement purposes):

Name	Features	Qty	Code no.
3.5 m, NTC 10K Sensor	Thermo plastic rubber probe	1	084N3210
8.5 m, NTC 10K sensor	Thermo plastic rubber probe	50	084N3208
1.5 m, NTC 10K sensor	Stainless steel probe	150	084N3200

Danfoss A/S

Climate Solutions • danfoss.com • +45 7488 2222

Any information, including, but not limited to information on selection of product, its application or use, product design, weight, dimensions, capacity or any other technical data in product manuals, catalogues descriptions, advertisements, etc. and whether made available in writing, orally, electronically, online or via download, shall be considered informative, and is only binding if and to the extent, explicit reference is made in a quotation or order confirmation. Danfoss cannot accept any responsibility for possible errors in catalogues, brochures, videos and other material. Danfoss reserves the right to alter its products without notice. This also applies to products ordered but not delivered provided that such alterations can be made without changes to form, fit or function of the product.

All trademarks in this material are property of Danfoss A/S or Danfoss group companies. Danfoss and the Danfoss logo are trademarks of Danfoss A/S. All rights reserved.