

Heat Exchangers

Finned coils

Coaxial heat exchanger

Tube bundle heat exchangers

Tube coil heat exchangers with housing

Special designs for serial parts

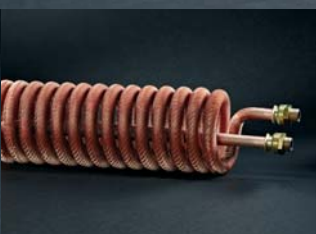

850 / 6 e



SCHMÖLE

We change Energy.

Schmöle GmbH

The Company

- More than 160 years of experience
- Outstanding quality
- 3 different finning processes
- 16 finning machines
- Different coiling and bending processes
- R & D partnership for your projects
- Highly skilled craftsmen
- Robust financial status and strong owners

The Product Range

Finned tubes and heat exchanger

- Rolled finned tubes
- Laser welded finned tubes
- Soldered finned tubes
- Corrugated tubes
- Finned coil
- Finned coil with fittings
- Coaxial heat exchanger
- Heat exchanger up to 150 kW
- Special constructions

Tube systems and surface heat exchanger

- Tubes with different dimensions and profiles
- Tube register
- Tube register with connecting elements
- Tube register on carrier
- Module with additional options
- Module with insulation
- Space solutions

Certification of Quality Management Systems

Our company is certified by independent bodies to the quality standards ISO 9001:2008 and PED 97/23/EC. Due to consistent quality awareness, we have gained a worldwide reputation as a reliable supplier.



SCHMÖLE

We change Energy.

Highest efficiency
meets effectiveness.

160 years of experience, modern production procedures and an extensive product range put Schmöle in the position to design heat exchangers in regard to:

High performance – Corrosion resistance Compactness – Reduced energy consumption

Many years of experience, modern production procedures and an extensive product range in low, medium and high finned tubes put Schmöle in the position to design heat exchangers in regard to:

- High performance
- Corrosion resistance
- Compactness
- Reduced energy consumption
- Environmental sustainable



Heat Exchangers

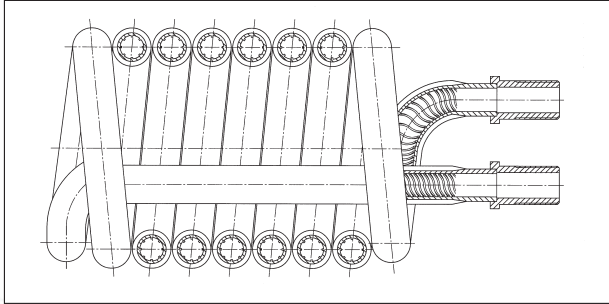

Schmöle is able to process a wide range of materials (copper, cupro-nickel, aluminium, carbon or stainless steel, nickel-base alloys, titanium). This expands our problem solving abilities in many fields of application and for various media.

By the use of special double walled safety tubes, heat exchangers are supplied with leak detecting possibilities which offer maximum safety when using aggressive media.

Schmöle supplies heat exchangers of various designs to the plant and apparatus engineering industries.

Heat exchangers in standard types are supplied ex stock to the following manufacturing industries:

- **Heating**
- **Refrigeration and air conditioning**
- **Mechanical engineering**

For automotive applications we design custom-made heat exchangers in close cooperation with the users to match all challenges of their processes.

Schmöle offers this service to all other industries.

Heat Exchangers

Finned Tube Coils

- BW ①
- SBW ②
- SBWT / BWT-S ③

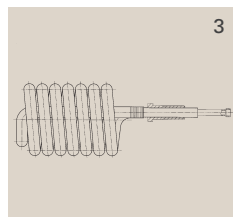
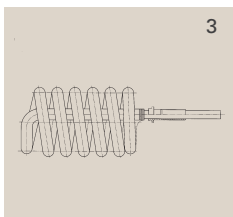
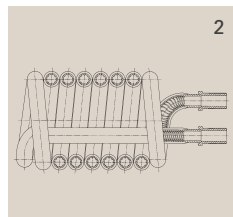
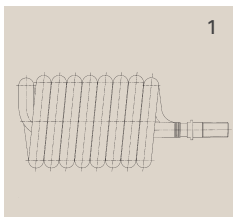
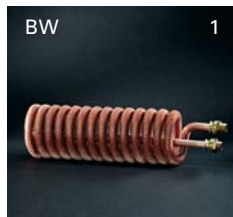

Coaxial Heat Exchangers

- Truco VS ④
- Truco K ⑤

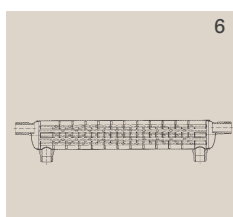
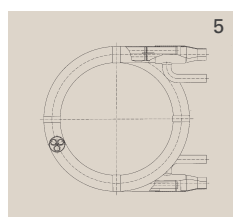
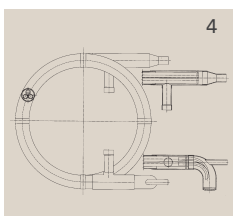

Tube Bundle Heat Exchangers

- RW-B ⑥
- RW-F / S ⑦

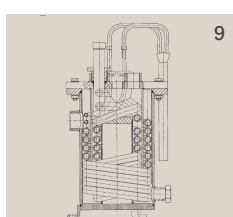
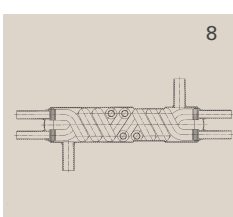
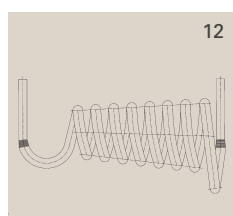
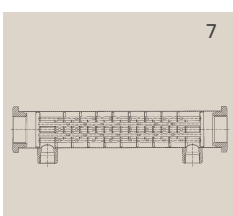

Shell and Coil Heat Exchangers

- HGW ⑧
- LRV ⑨
- LRK ⑩
- LOK / LVD ⑪

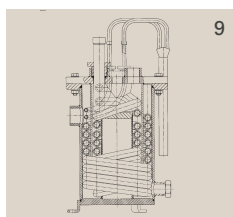
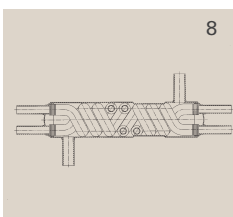
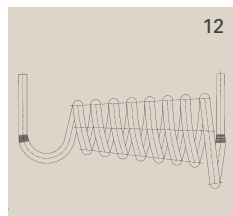
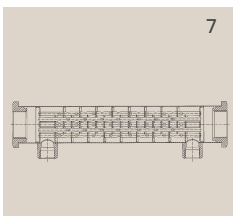

Special constructions

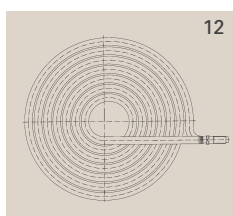
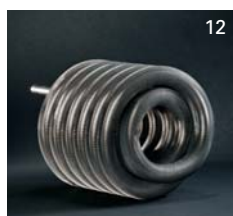
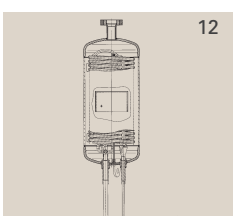
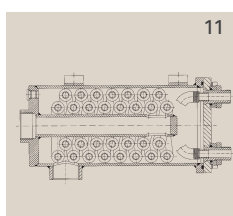
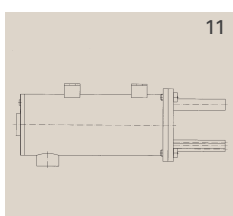
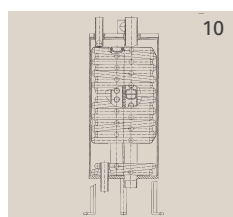

Special Constructions

Constantly increasing needs and limited space require very compact and efficient heat exchangers.

With high performance finned tubes, Schmöle develops a wide range of heat exchangers for all industrial sectors.



Stainless steel finned coils are produced from Laserfin[®] tubes. The excellent laser-welded connection between tube and strip enables an unproblematic bending and coiling of the finned tube.

Due to the compact design and optimal area ratio between inside and outside surface, coils with high performance can be realized in limited space.

This finned coil is highly corrosion-resistant and is used e.g. in the condensing technique.

Standard Heat Exchangers

The following tables provide performance data for standard heat exchangers produced by Schmöle under the specified operating conditions.

Type	Capacity	Operating conditions
Refrigerant evaporation		
Truco® VS	7 – 57 kW	Refrigerant R407 C Evaporating temperature 0 °C
LRV	9 – 32 kW	Heating medium Water Inlet temperature 12 °C
LVD	1 – 20 kW	Refrigerant R407 C Evaporating temperature 5 °C Heating medium Oil Inlet temperature 25 °C
Refrigerant condensation		
Truco® K	3 – 56 kW	Refrigerant R407 C
LRK	10 – 29 kW	Condensing temperature 45 °C
HGW	5 – 16 kW	Cooling medium Water
SBWT	1 – 5 kW	Inlet temperature 35 °C
Water heating		
BW	17 – 114 kW	Heating water temperature 80 °C Domestic water inlet temperature 10 °C Domestic water outlet temperature 45 °C
SBW	24 – 73 kW	Heating water temperature 75 °C Domestic water inlet temperature 10 °C Domestic water outlet temperature 45 °C
RW-B	16 – 48 kW	Heating water temperature 60 °C Domestic water inlet temperature 10 °C Domestic water outlet temperature 45 °C
RW-S	28 – 48 kW	Heating water temperature 70 °C Inlet temperature of the swimming pool 20 °C Outlet temperature of the swimming pool 28 °C
RW-F	12 – 32 kW	Heating water temperature 70 °C Water inlet temperature of the floor heating 35 °C Outlet temperature of the floor heating 45 °C

Type	Capacity	Operating conditions	
Cooling of superheated refrigerant vapour			
HGW	7 – 13 kW	Refrigerant	R407 C
		Hot gas inlet temperature	95 °C
		Condensing temperature	45 °C
		Cooling medium	Water
		Inlet temperature	35 °C
		Total capacity refrigeration unit	60 kW
Oil cooler			
LOK	3 – 111 kW	Heating medium	Oil
		Mean temperature	45 °C
		Cinematic viscosity	40 mm ² /s
		Cooling medium	Water
		Mean temperature	20 °C
LVD	1 – 20 kW	Heating medium	Oil
		Mean temperature	45 °C
		Cinematic viscosity	40 mm ² /s
		Cooling medium	R407 C
		Evaporating temperature	5 °C

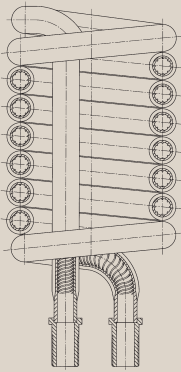
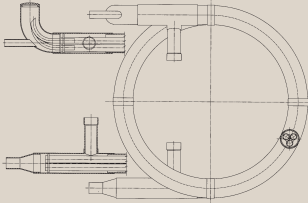
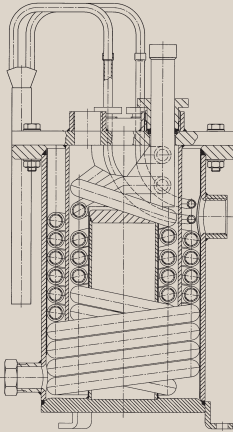
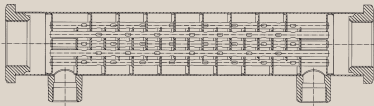

Heat Exchanger Types with Examples of Applications

Heat Exchanger Types	Leaflet No.	Sketch	Material	
			Shell	
BW Finned Tube Heating Coil	861		–	
SBW Finned Tube Instantaneous Flow Heater	864		–	
SBWT / BWT-S Finned Tube Condenser	871		–	
Truco® -Coaxial Evaporator VS	873		Copper, Cupro-Nickel	
Truco® -Coaxial Condenser K	874		Copper	
HGW Tube Coil Heat Exchanger	872		Cupro-Nickel	
LRV Tube Coil Evaporator	878		Steel (Outside painted)	
LRK-Tube Tube Condenser	879		Steel (Outside painted)	
LOK/LVD-Tube Coil Heat Exchanger	881		Steel (Outside painted)	
Tube Bundle Heat Exchanger RW-B	868		Copper	
Tube Bundle Heat Exchanger RW-F	868		Copper	
Tube Bundle Heat Exchanger RW-S	868		Cupro-Nickel Stainless Steel	

	Tubes	Tube Type	Examples of Application		
			Process	Medium outside	Medium inside
	Copper	Trufin® W/H (Outside electro-tinned)	Tank water heating	Domestic water	Heating water
	Copper (inside chemical-tinned)	Trufin® W/HT	Water heating	Heating water	Domestic water
	Copper	Trufin® W/HT (SWBT) Safety tube (BWT-S)	Tank water heating	Domestic water	Refrigerant
	Copper, Cupro-Nickel	S/RX Evaporator tube	Refrigerant evaporating	Heating water	Refrigerant
	Copper, Cupro-Nickel	Trufin® S/T	Refrigerant condensing	Refrigerant	Cooling water
	Copper	Trufin® W/HT	Hot gas cooling	Refrigerant	Cooling water
	Copper	Trufin® S/TT	Refrigerant evaporating	Heating water	Refrigerant
	Copper	Trufin® S/T	Refrigerant condensing	Refrigerant	Cooling water
	Copper, Cupro-Nickel (LOK)	Trufin® W/HT	Oil cooling	Oil	Cooling water (LOK)
	Copper	Dimpled tube	Water heating	Domestic water	Heating water
	Copper	Dimpled tube	Water heating	Heating water	Floor heating water
	Cupro-Nickel Stainless Steel	Dimpled tube	Water heating	Heating water	Swimming pool water

LOK-Tube Coil Heat Exchanger

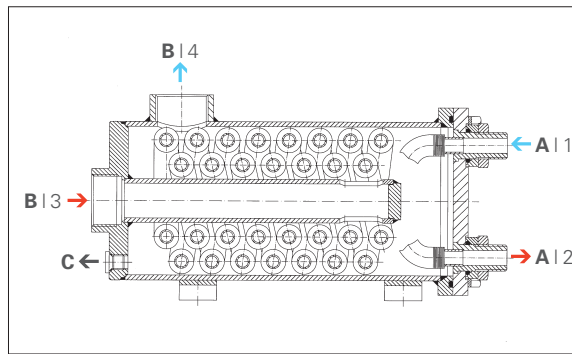

- A | Cooling water**
 - 1 _ Inlet
 - 2 _ Outlet
- B | Oil**
 - 3 _ Inlet
 - 4 _ Outlet
- C | Drainage**

HGW-Tube Coil Heat Exchanger

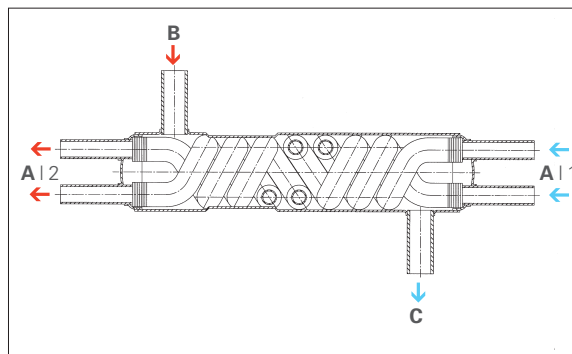

- A | Cooling medium**
 - 1 _ Inlet
 - 2 _ Outlet
- B | Hot gas / Superheated steam Inlet**
- C | Refrigerant vapor/ Refrigerant condensate Outlet**

Tube Coil Evaporator / Condenser

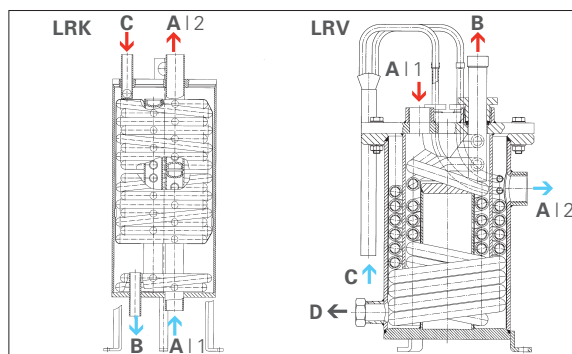

- A | LRK: Cooling medium**
LRV: Heating medium
 - 1 _ Inlet
 - 2 _ Outlet
- B | LRK: Refrigerant condensate**
LRV: Refrigerant gas outlet
- C | LRK: Refrigerant vapor/gas**
LRV: Liquid refrigerant
- D | Drainage**

RW-Tube Bundle Heat Exchanger

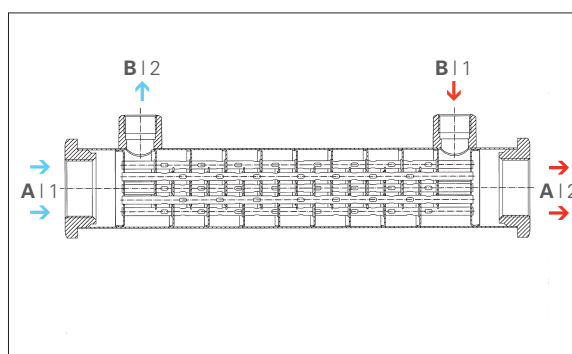

- A | RW F/S: Swimming pool / Floor heating water**
RW B: Heating water
 - 1 _ Inlet
 - 2 _ Outlet
- B | RW F/S: Heating water**
RW B: Domestic water
 - 1 _ Inlet
 - 2 _ Outlet

Truco®-Coaxial Evaporator VS

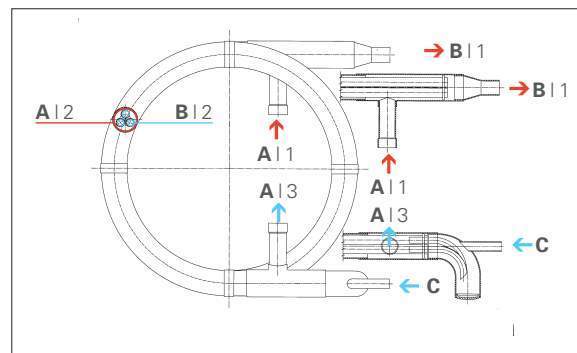

A | Heating medium

- 1 _ Inlet
- 2 _ In the shell
- 3 _ Outlet

B | Refrigerant gas

- 1 _ Outlet
- 2 _ In the tubes

C | Liquid refrigerant

- Inlet

Truco®-Coaxial Condenser K

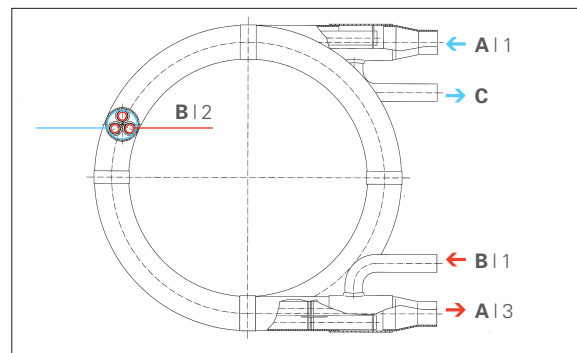

A | Cooling medium

- 1 _ Inlet
- 2 _ In the tubes
- 3 _ Outlet

B | Refrigerant gas

- 1 _ Inlet
- 2 _ In the shell

C | Refrigerant condensate

- Outlet

SBW-Finned Tube Condenser

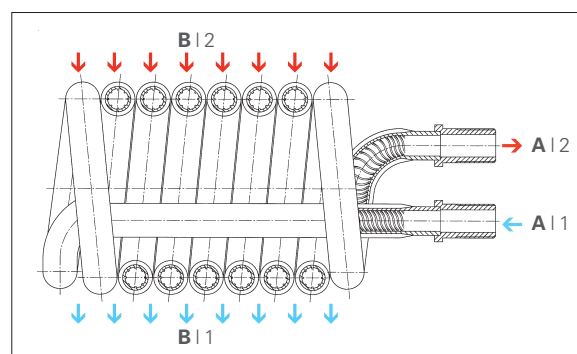
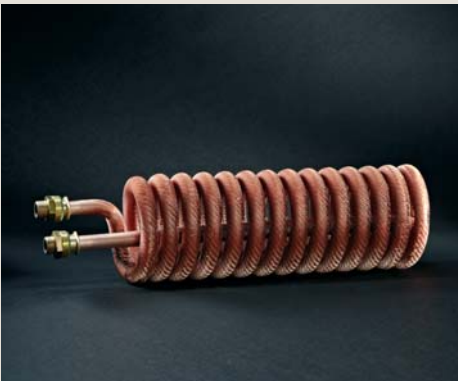

A | Domestic water

- 1 _ Inlet
- 2 _ Outlet

B | Heating water in the boiler

- 1 _ Hot
- 2 _ Cold

BW-Finned Tube Heating Coil

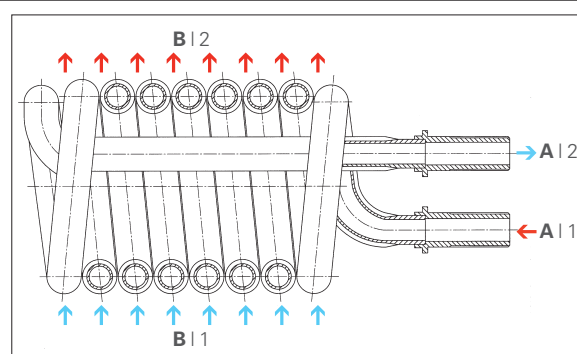

A | Heating water

- 1 _ Inlet
- 2 _ Outlet

B | Domestic water in the tank

- 1 _ Cold
- 2 _ Hot



Inspections and Testing

In order to verify the quality of our finned tubes, the following inspection and test methods are used:

Non-destructive Testing

- Eddy current test acc. to DKI¹⁾ 801
 ASTM B 359 / ASME SB 359
 ASTM E 309 / ASME SE 309
 ASTM E 426 / ASME SE 426
- Pneumatic pressure test under water
- Hydraulic pressure test

Destructive Testing

The following mechanical and structural properties are determined:

- Tensile strength
- Yield strength
- Elongation
- Grain size

Leakage Testing

- Nitrogen inside pressure test under water
- Helium test
- Differential pressure test

¹⁾ DKI = German Copper Institute, Düsseldorf



The Company

Schmöle GmbH is considered to be one of the leading manufacturers in the fields of finned tubes and heat exchangers.

Our clients expect both our involvement in solving their application-specific problems as well as a constantly being improved products and processes.

With 160 years of experience and a continued commitment to intensive research and development and modern manufacturing procedures, supported by a certified quality system, we shall continue to meet these challenges.

Schmöle GmbH has two product divisions:

Product Division 1: Finned tubes
Heat exchangers

Product Division 2: Ceiling cooling batteries
Surface heat exchanger

Quality Management

Manufacturing at Schmöle is accompanied by tests laid down in a Quality Assurance plan which is established for the individual product, containing all operations and examinations.

Schmöle, since 1993, is known for a certified Quality Management System according to DIN EN ISO 9001 as well as approval according to PED 97/23/EC.

By consistent development of the Quality Management System, Schmöle is familiar to its customers as a reliable business partners and manufacturer of high quality products.

We are looking forward to advise you!

Fon +49 (0)2373 975 500
Fax +49 (0)2373 975 720
info@schmoele.de

www.schmoele.de

Westick Plant
Schmöle GmbH
Westicker Straße 84
58730 Fröndenberg
Germany

Ardey Plant
Schmöle GmbH
Ardeyer Straße 15
58730 Fröndenberg
Germany

Stuckenacker Plant
Schmöle GmbH
Stuckenacker 6
58708 Menden
Germany



A member of the Surikate Group



SCHMÖLE

We change Energy.