

Date 13/5/2020
 Customer
 Offer



San Toribio, 6 28031 MADRID
 +34/913030426 com@frimetal.es

DIRECT EXPANSION EVAPORATOR

FRB-297

Model Capacity **4,2 kW**
 Required Capacity **0,0 kW**

Materials

Tubes Copper
 Fins Aluminium
 Casing Aluminun and galvanized steel white coated RAL-9002

Duties

Fin Spacing **7 mm**
 Air Flow **2750 m³/h**
 Air Velocity **1,74 m/s**
 Available Air Static Pressure **0 Pa**
 Air throw **13 m**
 Air Inlet Temperature **-20,0 °C**
 Outlet Air Temperature **-23,7 °C**
 Evaporating Temperature **-27,0 °C**
 Temperature difference DT1 **7 K**
 Refrigerant **R404A**

Options

Electrical defrost

Coil

Fin Spacing **7 mm**
 Finned Length **1100 mm**
 Surface **26,3 m²**
 Internal Volume **8,6 dm³**

Installer Information

Net weight **48 kg**
 Inlet liquid distributor **1 x 1/2"**
 Outlet line **1 x 22 mm**
 Electric defrost power **4400 W**

AC Fan motors ErP compliant

Power supply	1~230V/50Hz	Total absorbed power	160 W
Fans Nr.	2	Total absorbed current	0,8 A
Blade Diameter	300 mm	Noise Power Level	67 dB(A)
Speed	1350 rpm	Noise Pressure Level	36 dB(A)
		Distance	10 m

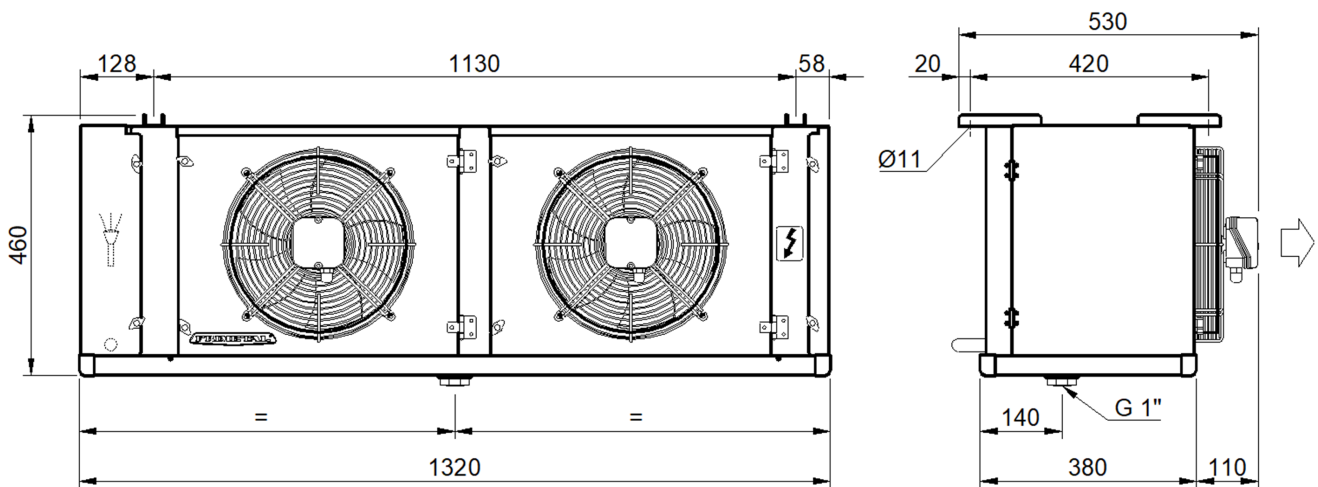

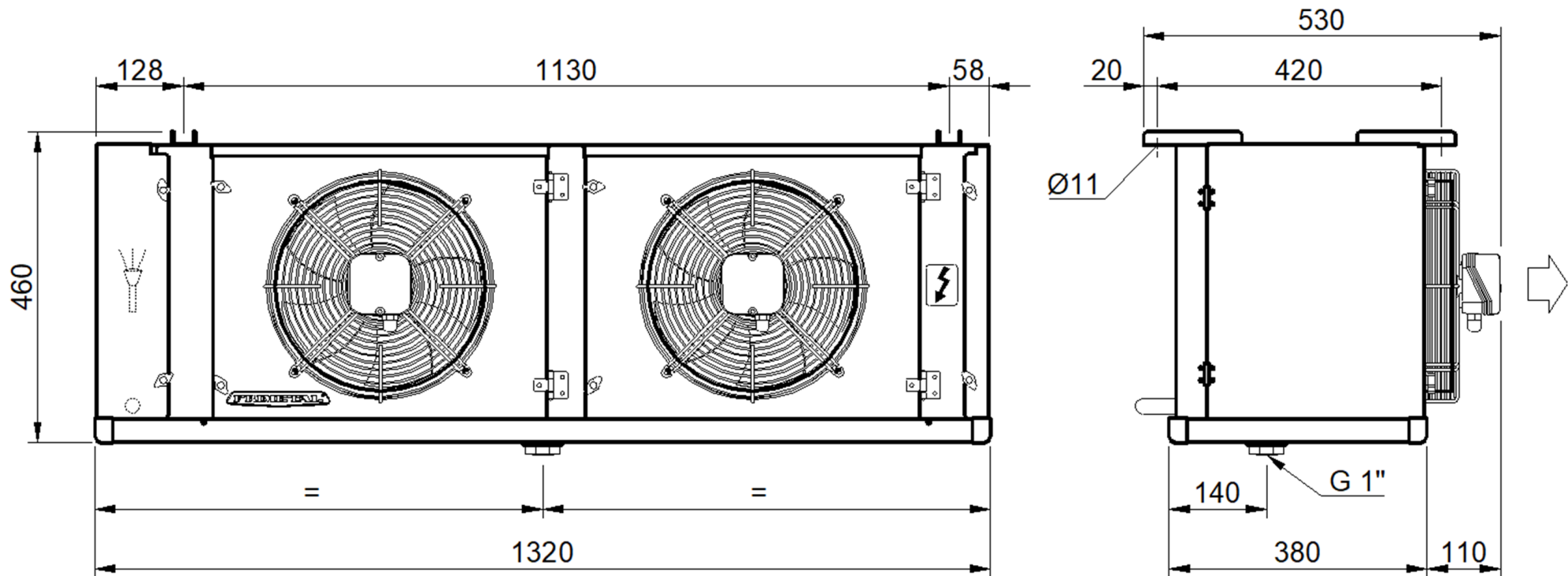

DIRECT EXPANSION EVAPORATOR - FRB-297



FRIMETAL, s.a.
 San Toribio, 6
 28031 MADRID
 +34/913030426 - +34/917774761