



REFRIGERATION AND  
AIR CONDITIONING

# INSTRUCTIONS

## EKA 163A / 164A



084R9970



R18KB700

084R9970

084R9970

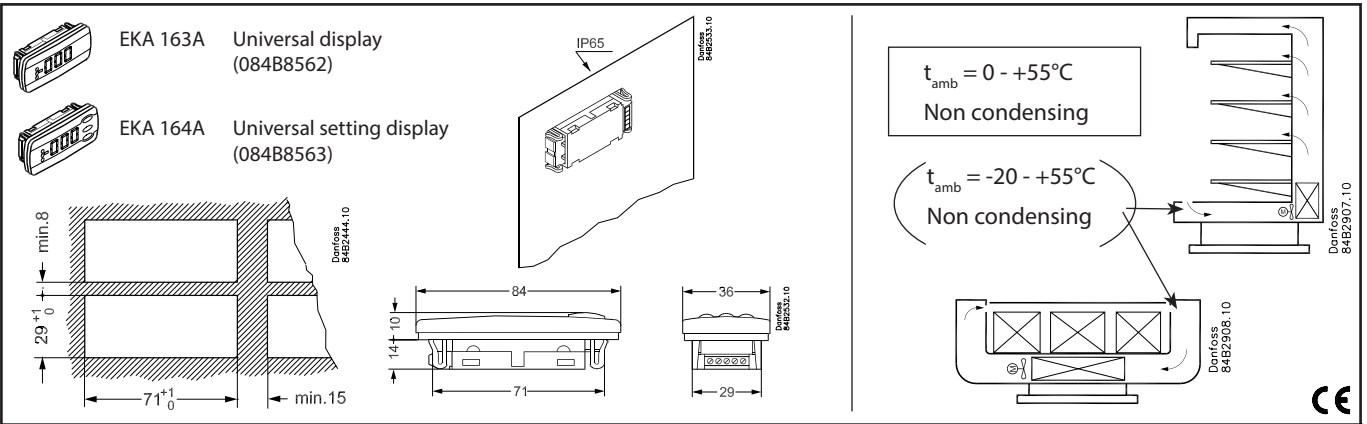

EKA 163A /  
EKA 164A → EKC 4xx / EKC 5xx / AK..

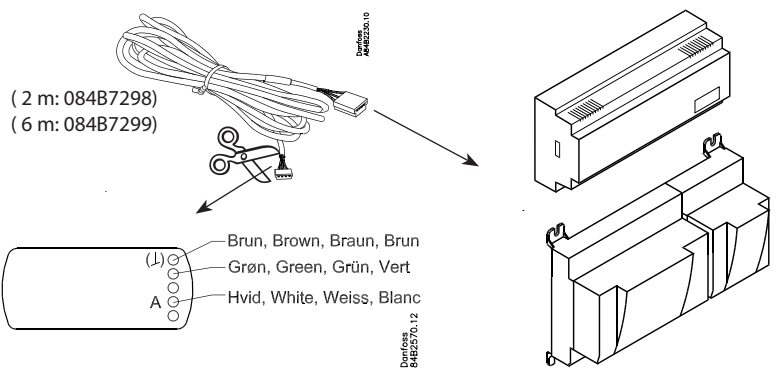
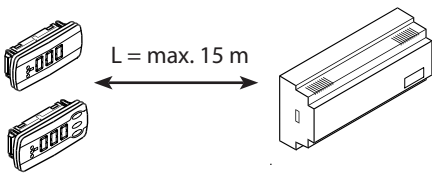

EKA 163A → EKC 202D / 204A1, AK-CC 210 / 260

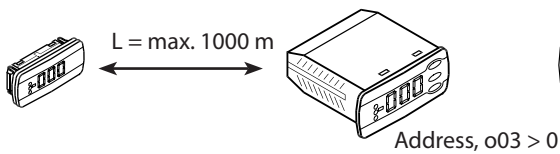

Data communication: See literature RC8AC

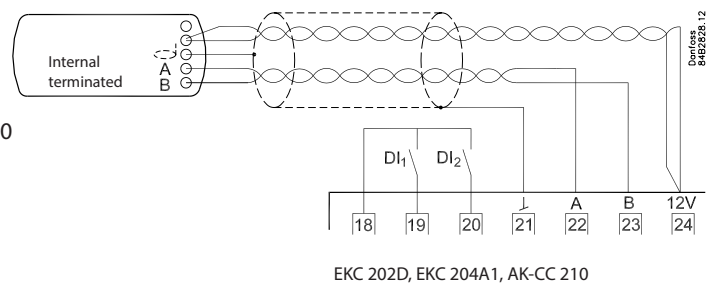

EKA 163A / 164A → AK-CC 450 / 550

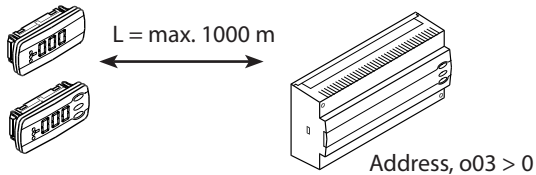

Data communication: See literature RC8AC

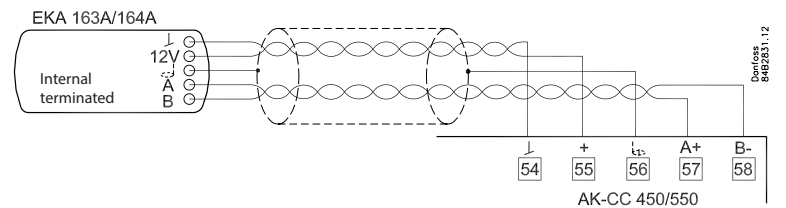

EKA 164A → EKD 316

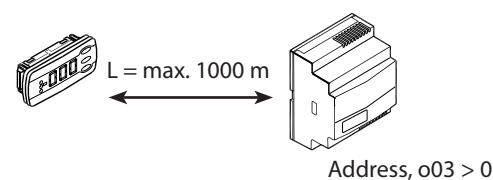

Data communication: See literature RC8AC

